

भारतीय मानक

जलशक्ति अन्तर्ग्रहण के जलीय डिजाइन के मापदण्ड

(पहला पुनरीक्षण)

Indian Standard

HYDROPOWER INTAKES — CRITERIA
FOR HYDRAULIC DESIGN

(First Revision)

UDC 627·84·04 : 621·22

© BIS 1995

BUREAU OF INDIAN STANDARDS
MANAK BHAVAN, 9 BAHADUR SHAH ZAFAR MARG
NEW DELHI 110002

FOREWORD

This Indian Standard (First Revision) was adopted by the Bureau of Indian Standards, after the draft finalized by the Intake Structures Sectional Committee had been approved by the River Valley Division Council.

An intake is provided in a hydroelectric development to let water into the water conductor system. The intake design should be such as to:

- a) Give minimum hydraulic losses;
- b) Prevent formation of air entraining vortices;
- c) Minimise sediment entry, specially in the case of run-of-the-river schemes; and
- d) Prevent ice and floating material from entering the conduit or penstock.

This standard was first published in 1981. This revision has been prepared to incorporate certain changes necessitated in view of comments received from user organizations based on their experience in the use of the standard. The salient changes that have been incorporated in this revision are listed below:

- i) Additional information has been laid down for run-of-the-river type intakes.
- ii) Intakes in concrete and masonry dam has been divided in two parts and figures depicting semi-circular as well as penstock re-entrant type intake have been incorporated.
- iii) Intakes in reservoir independent of dam have been illustrated.
- iv) Layout of intake structures have been elaborated to include antivortex devices such as perforated breast-walls.
- v) Details of side flaring entry have been incorporated as an illustration.

For the purpose of deciding whether a particular requirement of this standard is complied with, the final value, observed or calculated, expressing the result of a test or analysis, shall be rounded off in accordance with IS 2 : 1960 'Rules for rounding off numerical values (*revised*)'. The number of significant places retained in the rounded off value should be the same as that of the specified value in this standard.

Indian Standard

HYDROPOWER INTAKES — CRITERIA FOR HYDRAULIC DESIGN

(First Revision)

1 SCOPE

This standard describes the criteria for hydraulic design of hydropower intake structures.

2 TYPES AND CHOICE OF INTAKES

2.1 The position and location of intake would generally depend upon the type of development and may be broadly classified as under:

- a) Run-of-the-river type intakes, and
- b) Reservoir type intakes.

2.2 Run-of-the-River Type Intake

2.2.1 Run-of-the-river type intakes are those which draw water from the fresh continuous river inflows without any appreciable pondage upstream of the diversion structure.

2.2.1.1 Intake adjacent to diversion dams and barrages

In a Run-of-the-river type development without any appreciable pondage, an intake for tunnel is placed upstream of diversion dam or barrage. A typical detail is shown in Fig. 1.

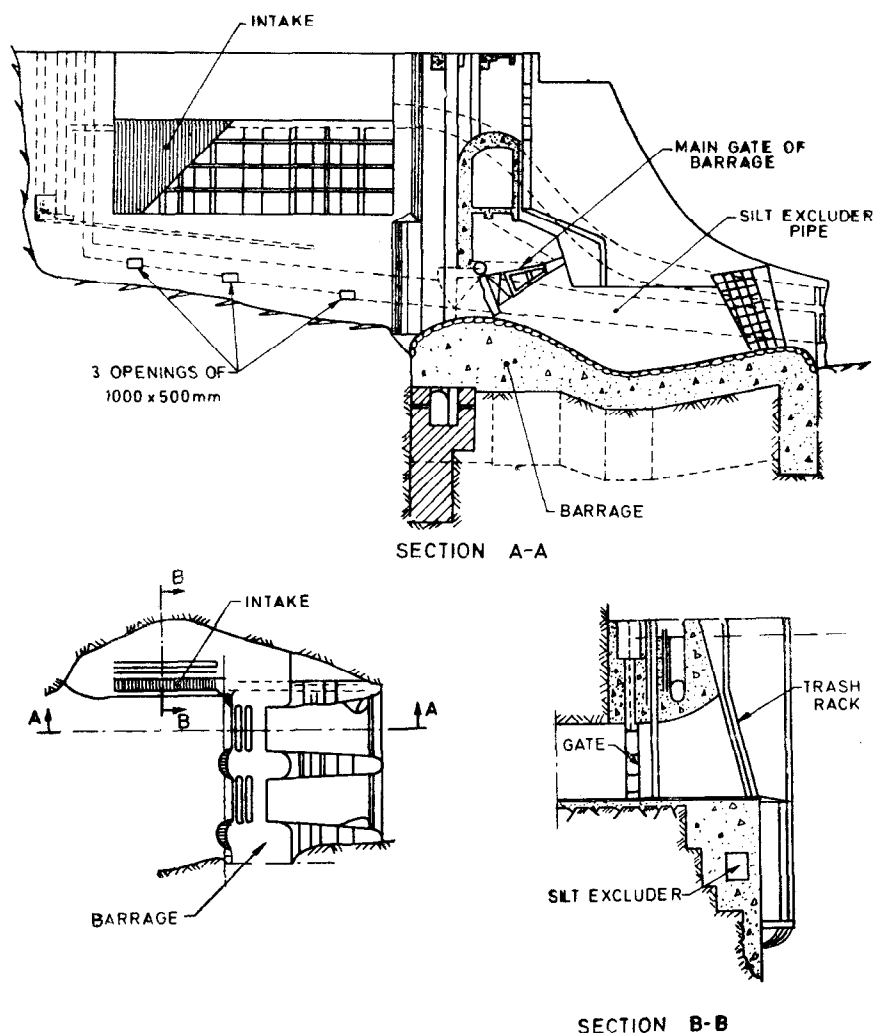

FIG. 1 INTAKE AT BARRAGE

2.2.1.2 Canal/river powerhouses intakes

A powerhouse with short intakes as a part of powerhouse structure is located across large canals or rivers to utilise head across a fall in canal or river. In such powerhouses, Kaplan turbines with concrete spiral casing or tubular turbines are used for power generation. In the former case, the intake forms a part of the passage to spiral casing and this is suitably streamlined to minimise hydraulic losses. Typical layouts are shown in Fig. 2 and Fig. 3.

2.2.1.3 Forebay intakes

In an open canal development, the open canal or free flow conduits terminate in a basin known

as forebay and intake for penstocks is provided in this forebay. A typical layout of forebay intake is shown in Fig. 4.

2.2.1.4 Drop type intake

A diversion structure, consisting of a trough trench and trash rack structure over it, is constructed across hilly streams to entrap the entire minimum discharge of the hilly stream. It is also called a trench type weir. Typical layouts are shown in Fig. 5.

2.2.1.5 Run-of-the-river type intake for hydro-power

For run-of-the-river scheme power generation, intakes are provided in the dam body as is being done in case of reservoir type intake.

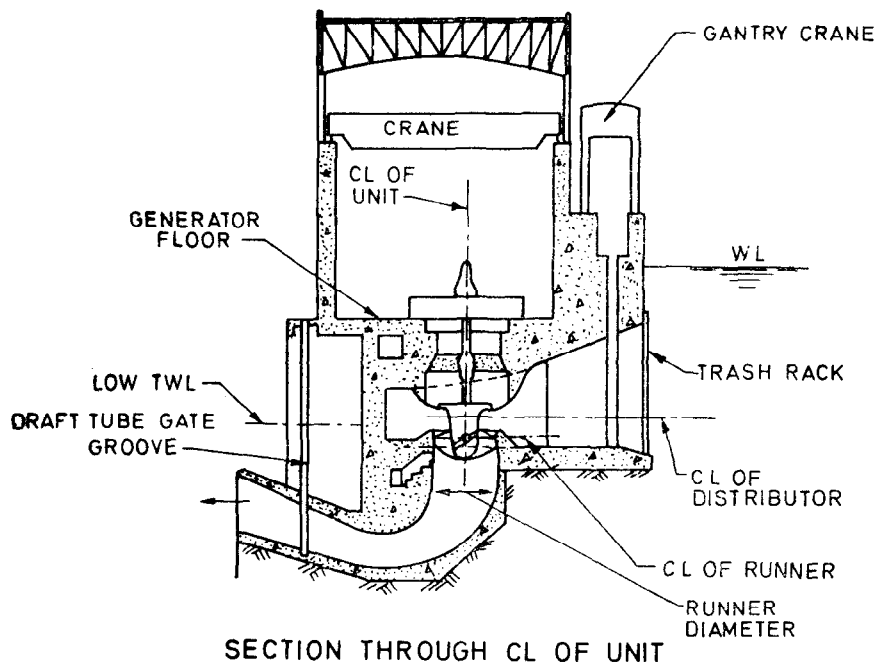
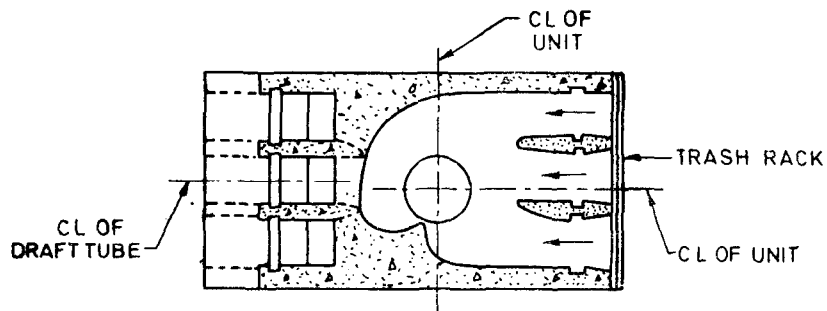

SECTION THROUGH CL OF UNIT
 FIG. 2 CANAL/RIVER POWER HOUSE INTAKES (KAPLAN TURBINES)

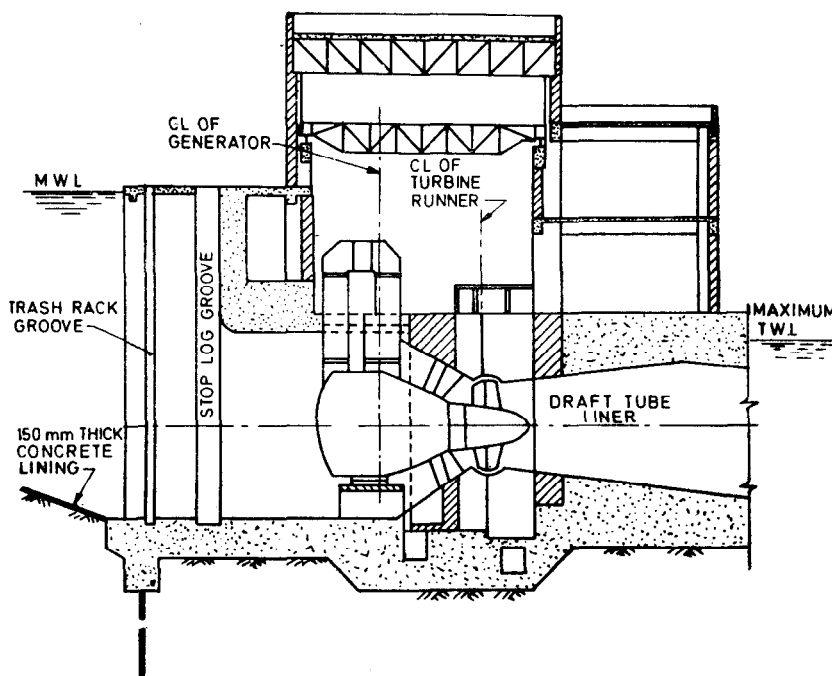

FIG. 3 CANAL/RIVER POWER HOUSE INTAKES (TUBULAR TURBINES)

2.3 Reservoir Type Intakes

2.3.1 Reservoir type intakes are provided where discharges for power generation are drawn from storage built up for this purpose. Depending on the head above the centre line of penstock, this is further categorised as under:

- a) Low head (up to 15 m),
- b) Medium head (15 to 30 m), and
- c) High head (above 30 m).

2.3.1.1 Intake in concrete or masonry dams

When power house is located at the toe of concrete or masonry dam and the water passage to turbine is embedded penstock through the body of dam, the intake structure for such penstocks is of semi circular type. A typical layout is shown in Fig. 6 and Fig. 7.

2.3.1.2 Re-entrant type of intake

This type of intake is generally provided either at upstream face of dam or in open channel with flat bottom, the typical layout of which is shown in Fig. 8.

2.3.1.3 Intake in earthen dam

When the reservoir is formed by an earthen dam and a conduit is laid below it, the intake

structure for such layout will be a sloping intake or tower type of intake. A typical layout for sloping type intake is shown in Fig. 9 and for tower type intake in Fig. 10.

2.3.1.4 Intakes in reservoir independent of dams

In the case of pressure tunnel taking off from a storage reservoir where the intake is located at a distance from the dam, the intake structure of such layout will be either tower type, semi-circular or inclined. A typical layout is shown in Fig. 11.

3 TYPICAL LAYOUT OF INTAKE STRUCTURE

3.1 The main components of an intake structure are:

- a) Bellmouth entrance and transition from rectangular to circular opening,
- b) Trash rack supporting structure,
- c) Gate slot enclosures with air vents, and
- d) Antivortex devices such as perforated breast-wall, etc.

3.1.1 The economic design of intake to serve its function will depend upon the condition in each project. In 5.1.3 and 5.1.5 some formulae have been indicated which may be modified to

suit special conditions. Hydraulic model studies may be necessary under special conditions.

3.2 The main type of layouts are as follows.

3.2.1 Semicircular Type of Intake Structure

In this layout, the rack supporting structure is placed in a semicircle plan in front of the conduit opening so that no part of rack falls within a radius of $1.1428 B$ from the face of the

opening (where B is the width of opening of the conduit). The main features of this layout are:

- a) Bellmouth entrance to conduit;
- b) Semicircular trash rack structure;
- c) Gate slot enclosure with airvent (typical details are shown in Fig. 6); and
- d) Antivortex devices such as breast-wall, etc.

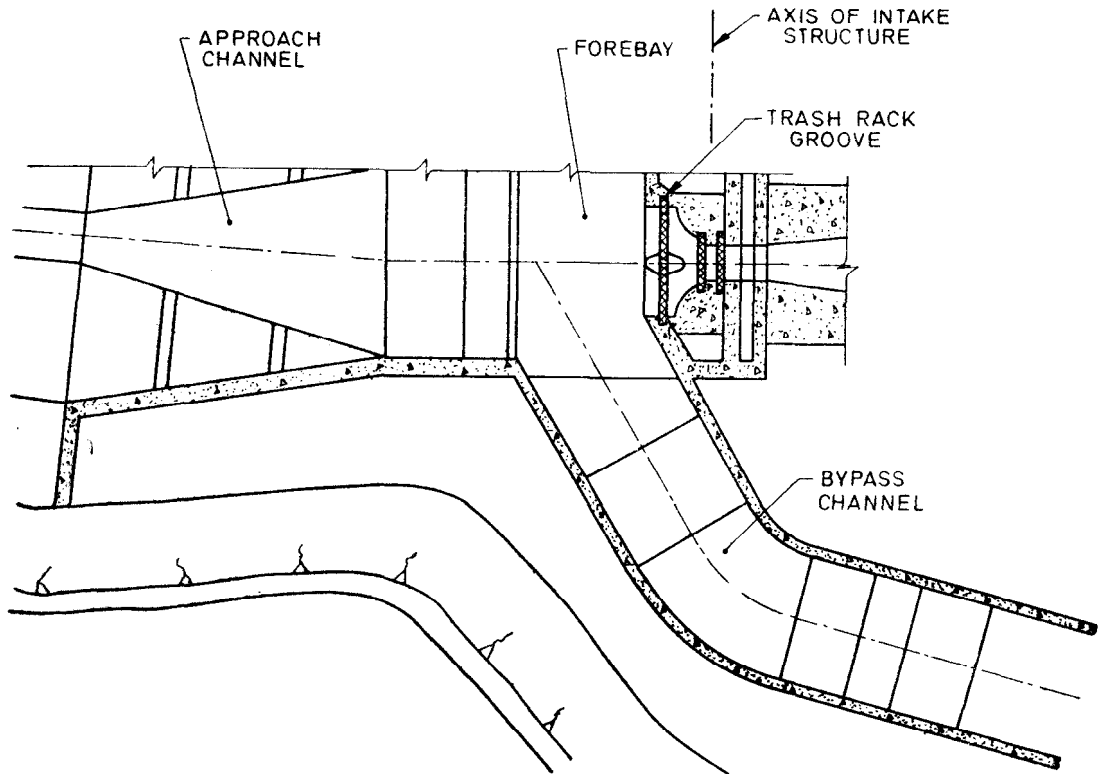

4A Plan

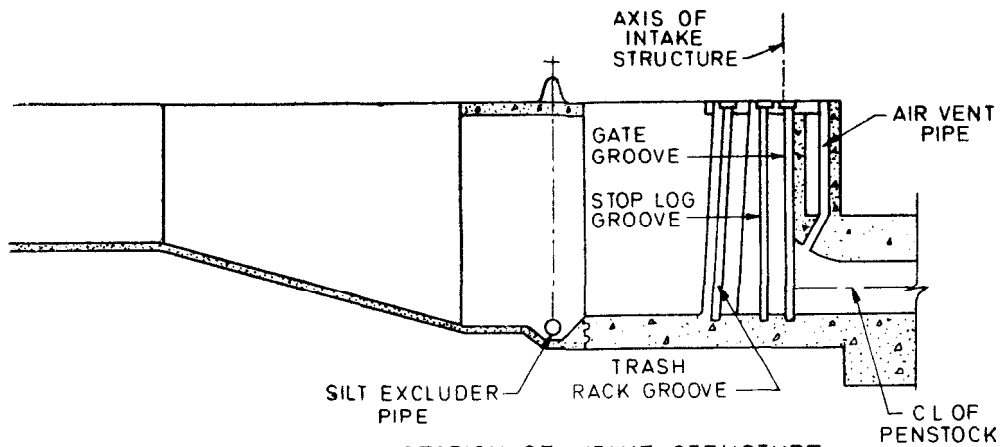

SECTION OF INTAKE STRUCTURE

4B Section of Intake Structure

FIG. 4 LAYOUT OF FOREBAY INTAKE

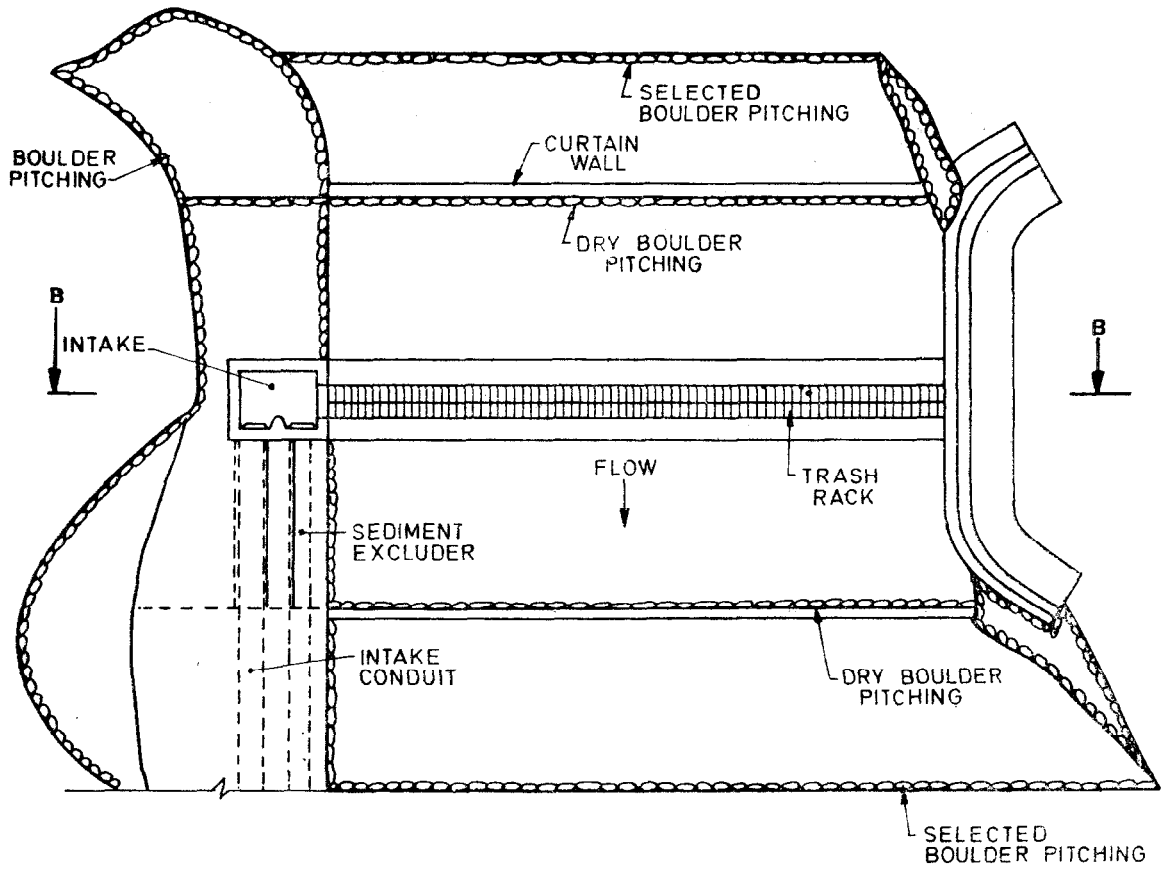

5A Plan

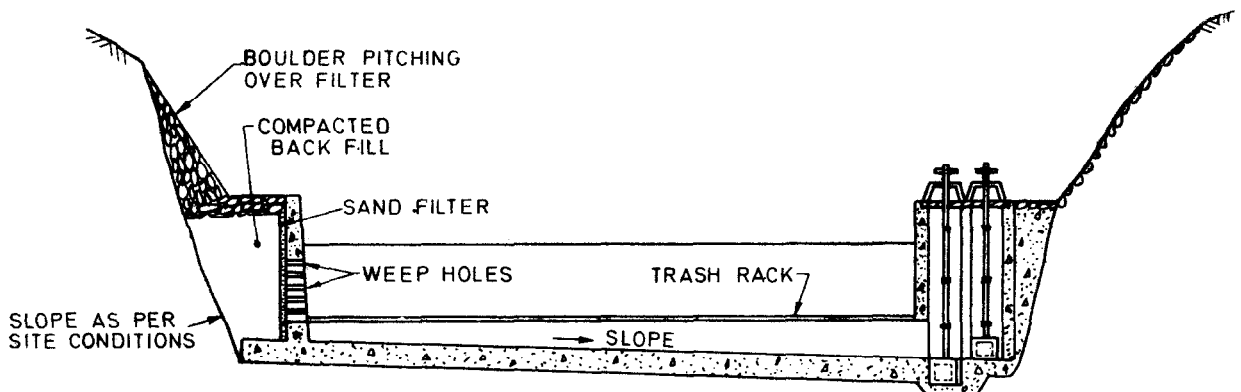

SECTION B B

5B

FIG. 5 DROP TYPE INTAKE

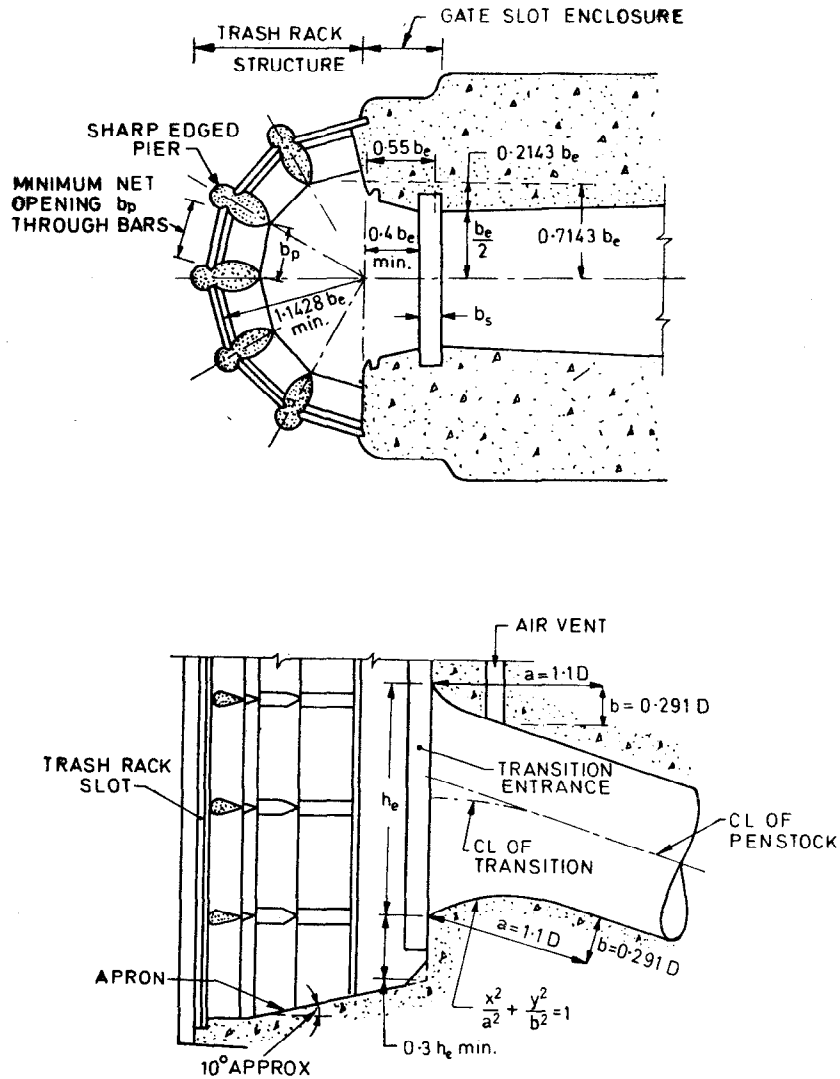

FIG. 6 SEMI CIRCULAR TYPE INTAKE STRUCTURE

3.2.2 Re-entrant Type Intake (see Fig. 8)

3.2.3 Straight Type of Intake Structure

In this layout, the rack supporting structure is straight with a vertical or inclined face. Where mechanical rakes with guides are provided, the trash rack should be kept inclined at an angle of at least 15° to the vertical. The main features of this layout are:

- a) Bellmouth transition;
- b) Vertical or inclined trash rack structure at the face of transition or away from the face;
- c) Gate slot enclosure with air vent (typical details are shown in Fig. 12); and
- d) Antivortex devices such as breast-wall, etc.

3.2.4 Tower Type of Intake Structure

Tower type of intake structure is a circular vertical shaft. The main features are:

- a) Circular tower type rack supporting structure;
- b) Circular bellmouth to shaft;
- c) Vertical shaft below tower type rack supporting structure; and
- d) Bend from shaft to tunnel with optional accelerating elbow and flare, depending on model studies.

The flow into tower is generally controlled either by a single cylindrical gate or by a number of gates in the tower type intake structure as shown in Fig. 10.

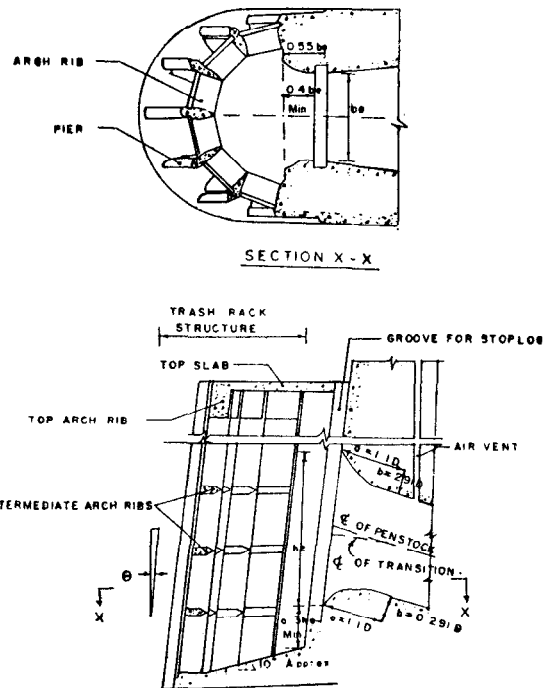
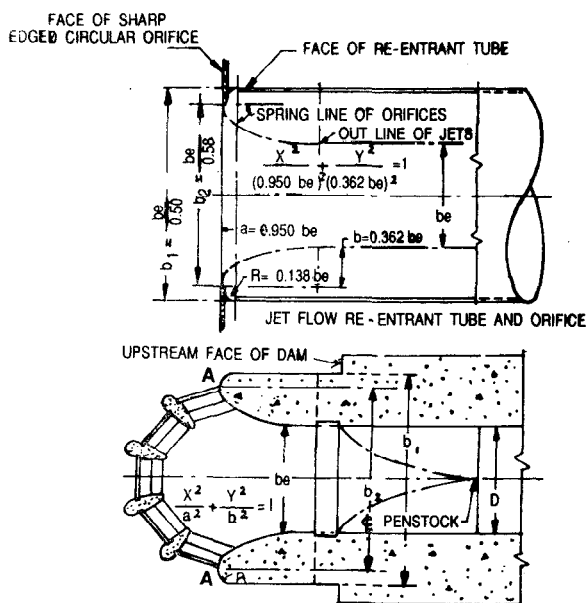

FIG. 7 SEMICIRCULAR TYPE INTAKE



Sectional Plan of Intake

FIG. 8 PENSTOCK INTAKE RE-ENTRANT TYPE

4 CONDITIONS FOR LOCATION AND LAYOUT OF INTAKE STRUCTURE

4.1 The choice of location of the intake structure depends upon:

- Type of development, that is, run-of-the-river or storage dam project;
- Location of power house *vis-a-vis* the dam;

- Type of water conductor system, that is, tunnel, canal or penstock;
- Topographical features of area;
- In cases where there is a considerable movement of boulders, stones and sand in the down stream direction, the intake should be arranged so that the effect of such movement will not lead to a partial restriction or blockage of the intake; in respect of storage reservoir intakes the sill level of the intake should be aimed to be kept above the sedimentation level at or near the dam face arrived at; and
- The intake can often be located so as to enable it to be constructed before the level of the reservoir is raised.

4.2 The typical layouts classified in 3.2.1 to 3.2.4, are adopted for a particular work based on requirements governed by prevailing condition. Conditions suitable for various layouts are given in 4.2.1 to 4.2.4.

4.2.1 Semicircular Type of Intake Structure

This type of layout is adopted:

- when a reservoir is formed by a high concrete or masonry dam and penstock conduit laid in the body of the dam;
- when the topography and geology permit to have almost vertical face to tunnel inlet portals; and
- when the minimum depth of water above the centre line is more than 0.8 of the entrance height (h_e).

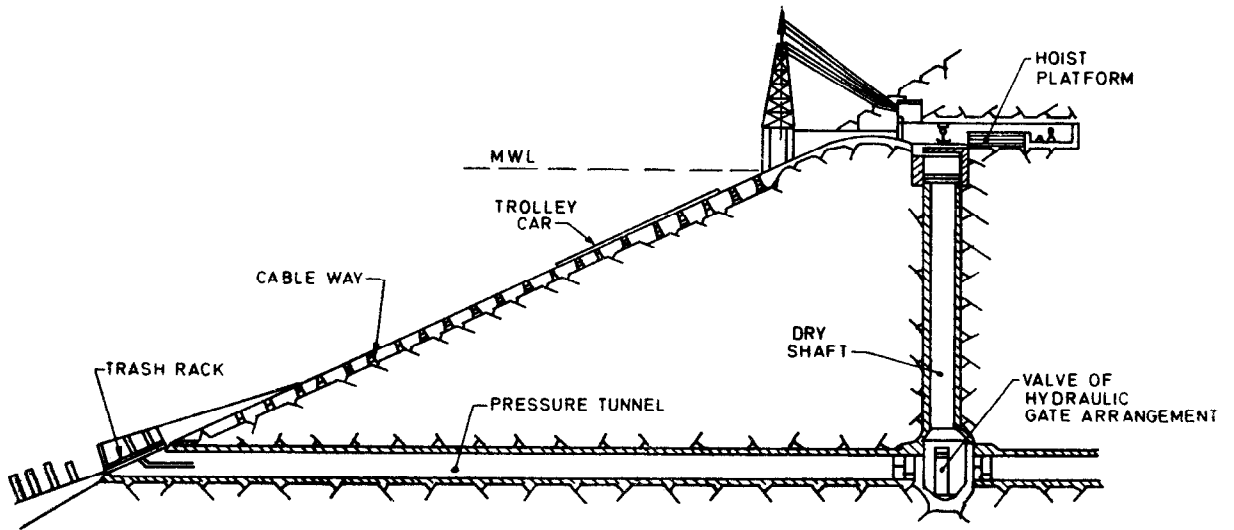

FIG. 9 SLOPING INTAKE FOR AN EARTH DAM

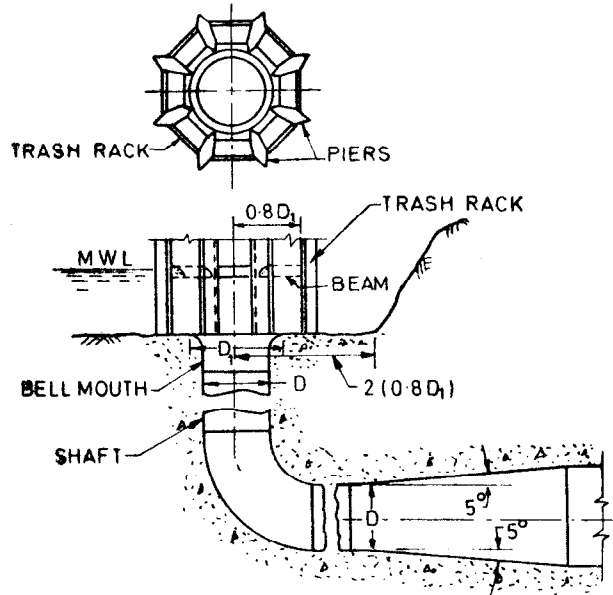

FIG. 10 TOWER TYPE INTAKE

4.2.2 Re-entrant Type Intake

This type of layout is adopted:

- a) on upstream face of dam;
- b) in open channel with flat bottom; and
- c) where the width of dam is inadequate to accommodate the intake.

4.2.3 Straight Type of Intake Structure

This type of layout is adopted:

- a) when the reservoir is formed by earthen dam and conduit is laid below it; and

- b) when the intake is subjected to low head variations like in run-of-the-river type.

4.2.4 Tower Type of Intake Structure

This type of layout is adopted:

- a) when the intake is located at a distance from the upstream face of the dam;
- b) when the reservoir is formed by the earthen dam and penstock tunnel is laid below it; and
- c) when the intake is subjected to large head variations, resulting in complete submergence of structure.

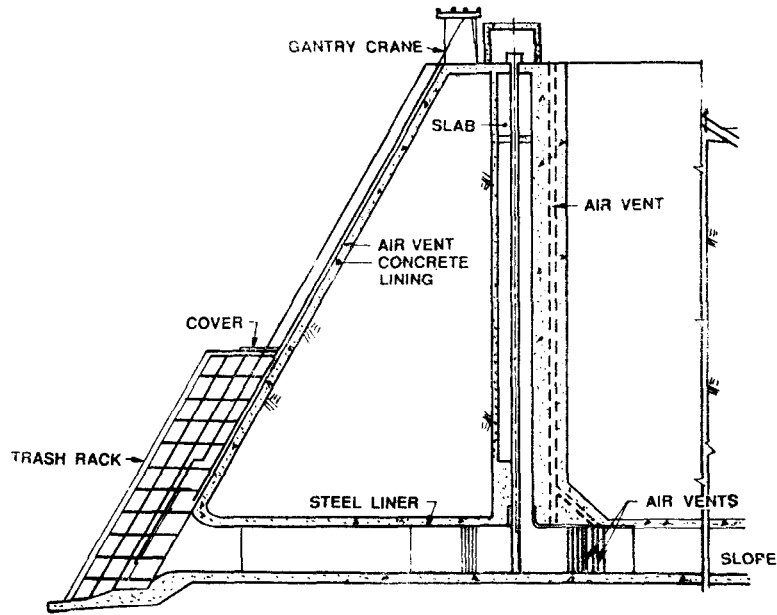

FIG. 11 INTAKE IN RESERVOIR INDEPENDENT OF DAMS

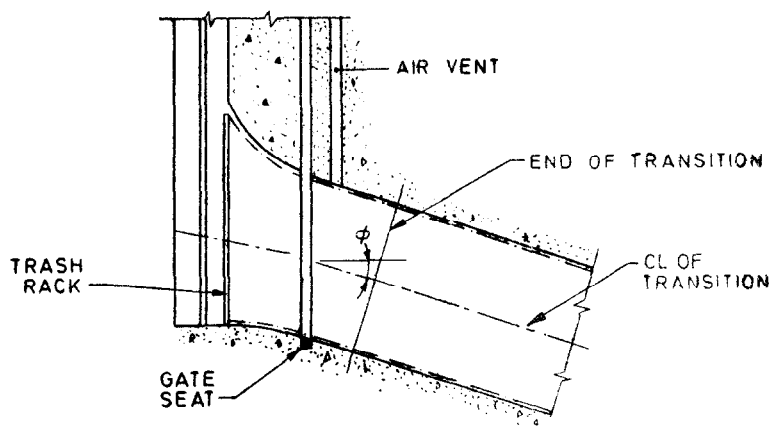
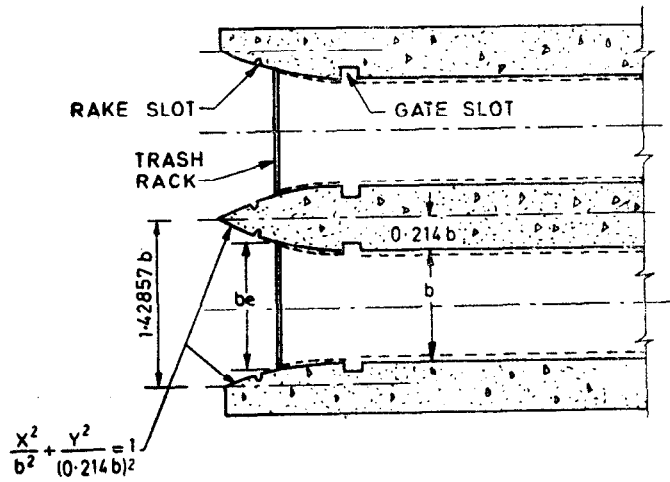

FIG. 12 STRAIGHT TYPE INTAKE

5 HYDRAULIC DESIGN OF COMPONENTS OF INTAKE

5.1 Bellmouth Opening and Transition

5.1.1 Shape and Size of Opening

The penstock and conduit entrance should be designed to produce an acceleration similar to that found in a jet issuing from a sharp edged orifice. The surface should be formed to natural contraction curve and the penstock or conduit is assumed to be the size of orifice jet at its maximum contraction.

5.1.2 The normal contraction of 40 percent ($C_c = 0.6$) should be used in high and medium head installations, 30 percent ($C_c = 0.7$) for low head installations and 50 percent ($C_c = 0.5$) for re-entrant type intake.

5.1.3 Opening Area

$$\text{Opening Area} = \frac{\text{Penstock Area}}{C_c \cos \phi}$$

where

ϕ = angle of inclination of penstock centre line to horizontal; and

C_c = co-efficient of contraction, as defined in 5.1.2.

5.1.4 Height and Width of Opening

The height is calculated from the distance above and below the intersect of the penstock centre line with the face of the entrance (see Fig. 13 for lower and upper nappe and Fig. 14 for details of side-flaring entry in plan).

$$h_1 = D \left[(1.21 \tan^2 \phi + 0.0847)^{1/2} + \frac{1}{2 \cos \phi} - 1.1 \tan \phi \right]$$

$$h_2 = D \left[\left(\frac{0.791}{\cos \phi} + 0.077 \tan \phi \right) \right]$$

$$h_e = h_1 + h_2$$

$$\text{Width of opening } b_e = \frac{\text{Area of opening}}{h_e}$$

5.1.5 Shape of Opening

The inlet should be streamlined to minimize the losses. The profile of the roof and floor should approximate to that of a jet from the horizontal slot. The profile is generally an ellipse given by the following equation:

$$\frac{X^2}{(1.1D)^2} + \frac{Y^2}{(0.291D)^2} = 1$$

NOTE — Hydraulic Model Studies may be conducted for important structures.

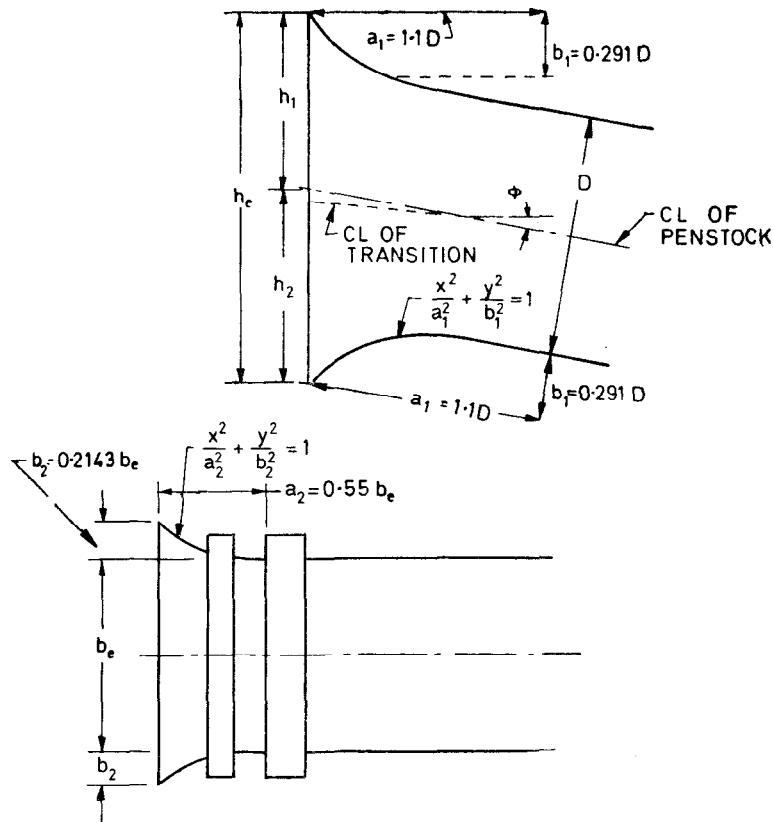

FIG. 13 BELLMOUTH DETAILS FOR LOWER AND UPPER NAPPE

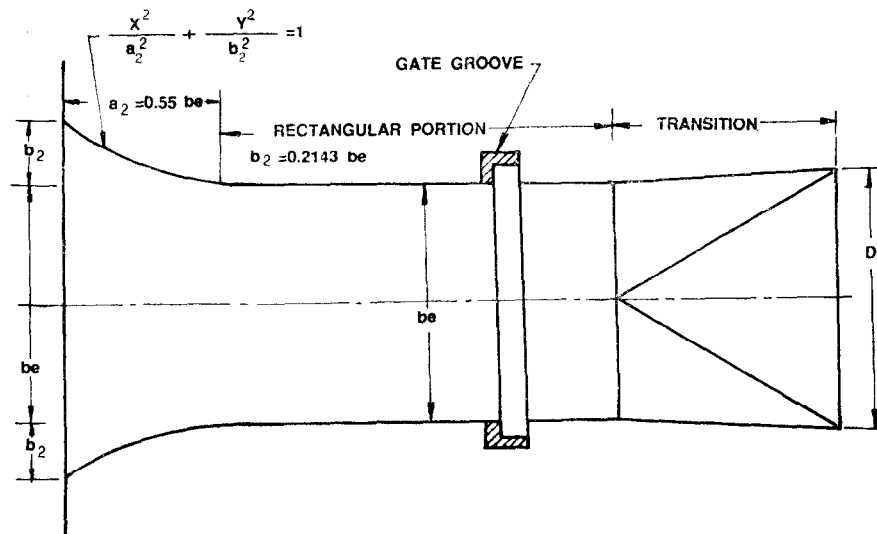

FIG. 14 DETAIL OF (SIDE FLARING) ENTRY IN PLAN

5.1.6 The profile of sides should be such that it should generally be followed by equation:

$$\frac{X^2}{(0.55 b_e)^2} + \frac{Y^2}{(0.2143 b_e)^2} = 1$$

While providing side flarings it may be ensured that the size of opening at entry does not create any structural problem with the size of dam block or structure. In case the dam block or structure in which the intake is to be accommodated has restrictions, the dimensions of side flaring should be restricted to that extent.

NOTE — Hydraulic Model Studies may be conducted for important structures.

5.1.7 Transitions

In order to obtain hydraulically efficient design of intake transitions from rectangular section to a circular section conduit, the transition should be designed in accordance with the following requirements:

- Transition or turns should be made about the centre line of mass flow and should be gradual,
- Side walls should not expand at a rate greater than 5° from the centre line of mass flow,
- All slots or other necessary departures from the neat outline should normally be outside the transition zone.

5.2 Centre Line of Intake

5.2.1 Formation of vortices at the intake depends on a number of factors such as

approach geometry, flow conditions, velocity at the intake, geometrical features of trash rack structure relative submergence depth and withdrawal Froude number, etc.

The geometry of the approach to the power intake should be such that it can ensure economy, and better hydraulic uniform flow condition. The flow lines should be parallel, having no return flow zone and having no stagnation. Velocity distribution in front of penstock should be uniform.

5.2.2 To prevent vortices, the centre line of intake should be so located as to ensure submergence requirements given in Fig. 18 which has been developed by an evaluation of minimum design submergence at prototypes operating satisfactorily.

For large size intakes at power plants:

$$\left(F_r = \frac{v}{\sqrt{gD}} \leq 1/3 \right)$$

especially at pumped storage system, a submergence depth,

$h = 1$ to 1.5 times the intake height or diameter is recommended.

For medium and small size installations ($F_r \geq 1/3$), especially at pump sumps, submergence requirements may be calculated using the formula:

$$\frac{h}{D} = 0.5 + 2 F_r$$

The recommendations are valid for intakes with proper approach flow conditions. With well

controlled approach flow conditions, with a suitable dimensioning and location of the intake relative to its surroundings and with use of antivortex devices submergence requirements may be reduced below the limits recommended above. However, recourse to hydraulic model studies may be taken to determine more accurate value depending on the specific parameters of the particular structure.

5.2.3 The requirement of water cover may be reduced with the provision of anti-vortex devices such as:

- a) Parallel vertical fins of R.C.C. on the upstream face of the power dam. Typical layout is shown in Fig. 15.
- b) Dinorwic louvered type. Typical layout is shown in Fig. 16.
- c) Perforated breast-wall. Typical layout is shown in Fig. 17.

5.3 Trash Rack Structure

5.3.1 A trash rack structure should be provided in front of a penstock or conduit to prevent the entrance of any trash that would not pass easily through the smallest opening in the turbine runner.

5.3.2 The shape of trash rack structure may be adopted to meet the requirements of the head-works layout and head loss. For instance, for high dams with nearly vertical upstream face, semi-circular trash rack structure is usually preferred to provide the required trash rack area economically. For low dams or diversion structures, a straight trash rack is usually preferred. However, model studies required for suitability of shape and size of piers and beams of trash racks should also aim at to prevent dead zones of water and uneven or irregular flow patterns in the tunnel, formation of dimples, dye core and aircore vortices, water circulation and other flow irregularities during operation in pumping, turbine or combine modes under symmetrical and asymmetrical operation of unit.

5.3.3 No part of the trash rack structure should fall within 80 percent of the intake height, h_e , from the centre point of intake.

5.3.4 For an upright semicircular intake structure (as in Fig. 6), the racks should be located on a semicircle in plan with a minimum radius of $1.1428 b_e$ where b_e is the width of opening.

For an inclined semicircular intake structure, (as in Fig. 7), the racks should be located on a semicircle or a plane perpendicular to the axis of the structure and satisfying the other criteria

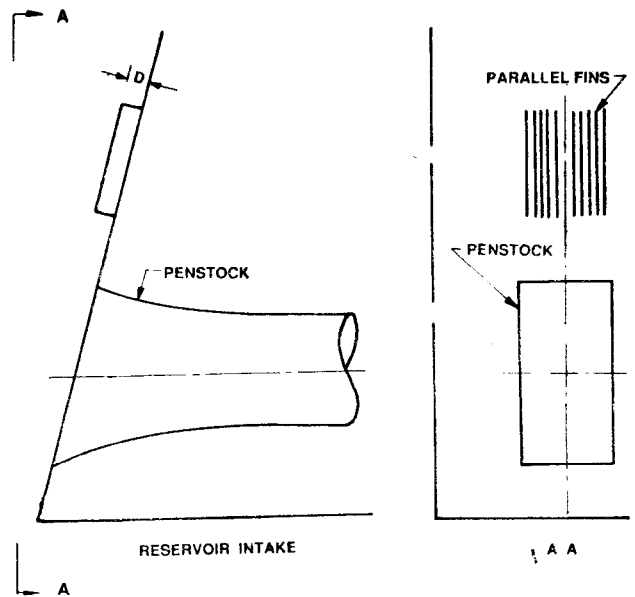

FIG. 15 ANTI VORTEX DEVICE (PARALLEL FIN) AT THE RESERVOIR INTAKE

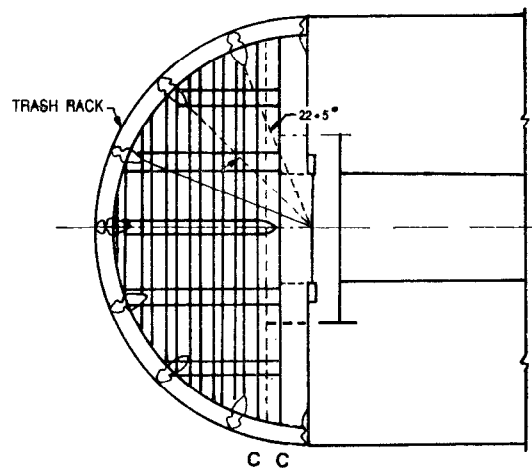
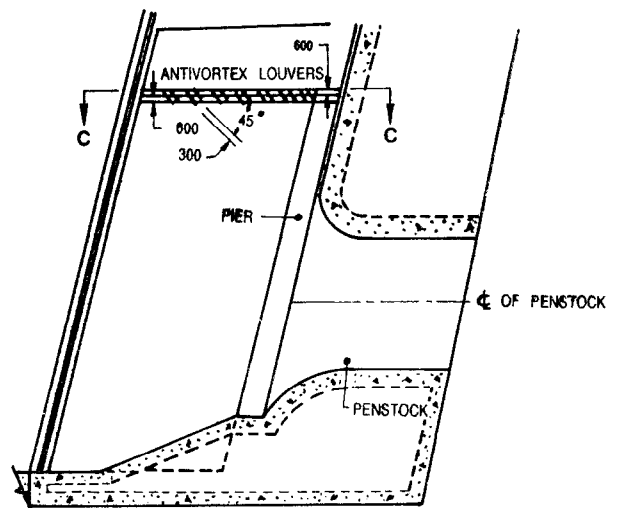

FIG. 16 DINORWIC TYPE ANTI VORTEX DEVICE AT POWER INTAKE

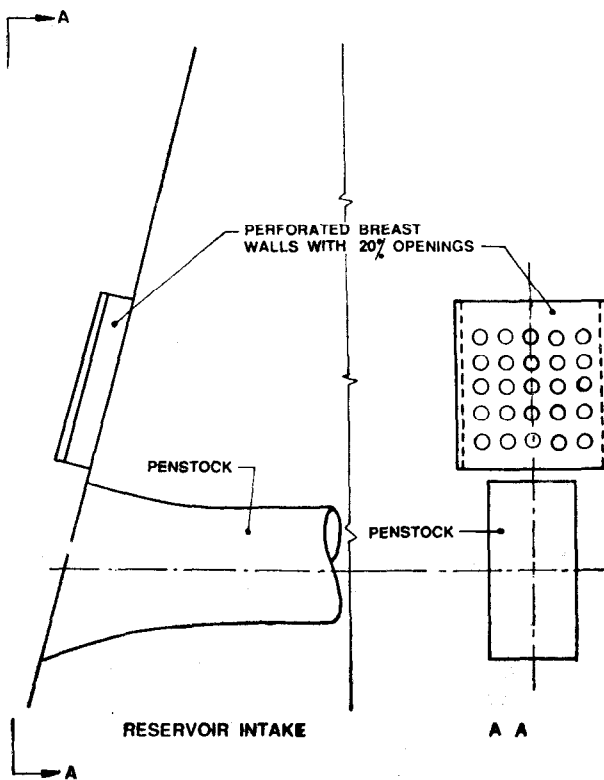

FIG. 17 ANTI VORTEX DEVICE (PERFORATED BREAST-WALL) AT THE RESERVOIR INTAKE

as for the upright structure. In plane the racks would be laid out on an ellipse, the semi-major axis of which should have a minimum value of:

$$\frac{1.1428 b_a}{\cos \theta}$$

where θ is the inclination of the trash rack axis to the vertical. The semi minor axis of the structure is parallel to the dam face and would have a value of $1.1428 b_e$. The trash rack screens should be inclined in a three dimensional plane with a bottom corner of the tower screens resting over the base footing.

Suitable fillet should be provided below the lowest screens to plug the gap and effectively support the weight of the trash rack over the entire base.

For shaft intakes (as in Fig. 10), the racks should be located at $0.8 D_1$ from the centre of the bellmouth, where D_1 is the inlet diameter of the bellmouth.

5.3.5 The piers and beams of the trash rack supporting structure should be sharp nosed and should be streamlined about the required structural section.

5.3.6 The normal velocity of flow through the rack structure is indicated below:

For units with hand raking,

$$V = 0.75 \text{ m/s}$$

For units with mechanical raking

$$V = 1.5 \text{ m/s}$$

5.3.7 Trash bars should be so spaced that the net opening between them should be at least 5 mm less than the minimum opening between turbine runner blades.

5.3.8 The trash rack should also be designed to withstand the effect of submerged jets in the case of pumped storage scheme. The spacing of the bars should be adjusted so that the ratio of forcing frequency to natural frequency of bar is less than 0.6.

5.3.9 For the design of trash rack piers, ribs and trash rack screens, a minimum differential head of 3-6 m may be adopted depending upon the efficiency of the cleaning of trash racks being adopted.

For the design of perforated breast-wall, anti-vortex louvers and vertical fins, a minimum of 1 m differential head may be adopted.

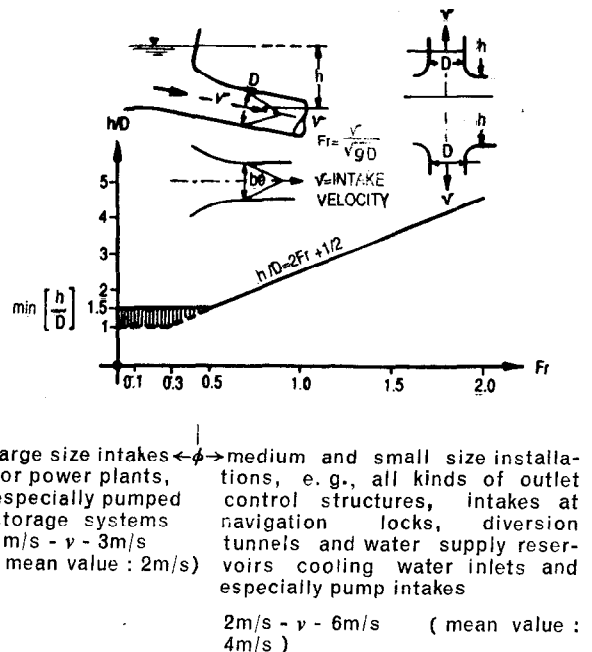

FIG. 18 RECOMMENDED SUBMERGENCE FOR INTAKES WITH PROPER APPROACH FLOW CONDITION BUT WITHOUT USE OF SPECIAL DEVICES FOR VORTEX SUPPRESSION

5.4 Intake Gate and Air Vent

5.4.1 The intake gate slot should be enclosed in a structure designed to guide the water into the rectangular opening without side contraction.

5.4.2 The upstream edge of the gate slot should be at least $0.40 b_0$ from the nose, where b_0 is the width of opening.

5.4.3 Where gates are located in a gate shaft, suitable transition from circular to rectangular gate slot should be provided.

5.4.4 An air vent downstream of intake gate should be provided. The air vent should be so designed as to admit air at the rate the turbine is discharging water under full gate conditions.

The area of air vent may be fixed by the following formula:

$$F = \frac{Q \sqrt{S} (D/t)^{3/2}}{750 000 c}$$

where

- F = Area of air vent pipe in m^2 ,
- Q = Maximum discharge through penstock. Discharge of air through penstock is taken as 21 to 22 percent of penstock discharge,
- S = factor of safety against collapse of pipe (normally assumed between 3 and 4),
- D = diameter of penstock in m,
- t = thickness of penstock in m, and

c = co-efficient of discharge through inlet (0.5 for ordinary type of intake valves and 0.7 for short air inlet pipes).

5.5 Approach Apron

The approach apron should not be placed closer than 30 percent of the intake height h_0 from the lower edge of the intake orifice.

6 MISCELLANEOUS ARRANGEMENT

6.1 Whenever the intakes are provided at high altitude above snow line, necessary provision for arresting the formation of ice cover on rack bars and gate should be made for the free flow of water. These de-icing arrangements are as under:

- a) Bubbler system, and
- b) Heating arrangement.

6.2 Floating ice should be arrested by providing ice booms of concrete baffles at intakes.

6.3 Raking Arrangement

Arrangement should be made for removing debris from trash racks at regular intervals or with continuous raking arrangements in the case of intake where floating material is expected to be attracted continuously to the racks due to the abundance of floating material in the flow and the level of water being often near about trash rack levels.

6.4 In the case of run-of-the-river type projects, where the requirements of silt exclusion are more stringent, separate arrangements should be made for silt exclusion.

Bureau of Indian Standards

BIS is a statutory institution established under the *Bureau of Indian Standards Act, 1986* to promote harmonious development of the activities of standardization, marking and quality certification of goods and attending to connected matters in the country.

Copyright

BIS has the copyright of all its publications. No part of these publications may be reproduced in any form without the prior permission in writing of BIS. This does not preclude the free use, in the course of implementing the standard, of necessary details, such as symbols and sizes, type or grade designations. Enquiries relating to copyright be addressed to the Director (Publications), BIS.

Review of Indian Standards

Amendments are issued to standards as the need arises on the basis of comments. Standards are also reviewed periodically; a standard along with amendments is reaffirmed when such review indicates that no changes are needed; if the review indicates that changes are needed, it is taken up for revision. Users of Indian Standards should ascertain that they are in possession of the latest amendments or edition.

This Indian Standard has been developed from Doc No: RVD 11 (48).

Amendments Issued Since Publication

Amend No.	Date of Issue	Text Affected

BUREAU OF INDIAN STANDARDS

Headquarters:

Manak Bhavan, 9 Bahadur Shah Zafar Marg, New Delhi 110002
Telephones : 331 01 31, 331 13 75

Telegrams : Manaksanstha
(Common to all offices)

Regional Offices :

	Telephone
Central : Manak Bhavan, 9 Bahadur Shah Zafar Marg NEW DELHI 110002	{ 331 01 31 331 13 75
Eastern : 1/14 C. I. T. Scheme VII M, V. I. P. Road, Maniktola CALCUTTA 700054	{ 37 84 99, 37 85 61 37 86 26, 37 86 62
Northern : SCO 335-336, Sector 34-A, CHANDIGARH 160022	{ 60 38 43 60 20 25
Southern : C. I. T. Campus, IV Cross Road, MADRAS 600113	{ 235 02 16, 235 04 42 235 15 19, 235 23 15
Western : Manakalaya, E9 MIDC, Marol, Andheri (East) BOMBAY 400093	{ 632 92 95, 632 78 58 632 78 91, 632 78 92

Branches : AHMADABAD. BANGALORE. BHOPAL. BHUBANESHWAR.
COIMBATORE. FARIDABAD. GHAZIABAD. GUWAHATI. HYDERABAD.
JAIPUR. KANPUR. LUCKNOW. PATNA. THIRUVANANTHAPURAM.