

STANDARDS/MANUALS/ GUIDELINES FOR SMALL HYDRO DEVELOPMENT

1.2 and 2.1

General / Civil Works – Planning and Layouts

Sponsor:

Ministry of New and Renewable Energy
Govt. of India

Lead Organization:

Alternate Hydro Energy Center
Indian Institute of Technology Roorkee

June 2013

Contact:

Dr Arun Kumar

Alternate Hydro Energy Centre,
Indian Institute of Technology Roorkee,

Roorkee - 247 667, Uttarakhand, India

Phone : Off.(+91 1332) 285821, 285167

Fax : (+91 1332) 273517, 273560

E-mail : aheciitr.ak@gmail.com, akumafah@iitr.ernet.in

DISCLAIMER

The data, information, drawings, charts used in this standard/manual/guideline has been drawn and also obtained from different sources. Every care has been taken to ensure that the data is correct, consistent and complete as far as possible.

The constraints of time and resources available to this nature of assignment, however do not preclude the possibility of errors, omissions etc. in the data and consequently in the report preparation.

Use of the contents of this standard/manual/guideline is voluntarily and can be used freely with the request that a reference may be made as follows:

AHEC-IITR, "1.2 and 2.1 General/ Civil Works – Planning and Layouts", standard/manual/guideline with support from Ministry of New and Renewable Energy, Roorkee, June 2013.

PREAMBLE

There are series of standards, guidelines and manuals available on electrical, electromechanical aspect of moving machines and hydro power related issues from Bureau of Indian Standards (BIS), Rural Electrification Corporation Ltd (REC), Central Electricity Authority (CEA), Central Board of Irrigation & Power (CBIP), International Electromechanical Commission (IEC), International Electrical and Electronics Engineers (IEEE), American Society of Mechanical Engineers (ASME) and others. But most of these are developed keeping in view the large water resources/ hydropower projects. Use of the standards/guidelines/manuals is voluntary at the moment. Small scale hydropower projects are to be developed in a cost effective manner with quality and reliability. Therefore a need to develop and make available the standards and guidelines specifically developed for small scale projects was felt.

Alternate Hydro Energy Centre, Indian Institute of Technology, Roorkee initiated the exercise of developing standards/guidelines/manuals specifically for small scale hydropower projects under the sponsorship of Ministry of New and Renewable Energy, Government of India, in 2006. The available relevant standards / guidelines / manuals were revisited to suitably adopt them for small scale hydro projects. These have been prepared by experts in their respective fields. Wide consultations were held with all stake holders covering government agencies, government and private developers, equipment manufacturers, consultants, financial institutions, regulators and others through web, post and meetings. After taking into consideration the comments received and discussions held with the lead experts the standards/guidelines/manuals are now prepared and presented in this publication.

The experts have drawn some text and figures from existing standards, manuals, publications and reports. Attempts have been made to give suitable reference and credit. However, the possibility of some omission due to oversight cannot be ruled out. These can be incorporated in our subsequent editions.

These standards / manuals / guidelines are the first edition. We request users of these to send their views / comments on the contents and utilization to enable us to review these after about one year of its publication.

Standards/ Manuals/Guidelines series for Small Hydropower Development

General	
1.1	Small hydropower definitions and glossary of terms, list and scope of different Indian and international standards/guidelines/manuals
1.2 Part I	Planning of the projects on existing dams, Barrages, Weirs
1.2 Part II	Planning of the Projects on Canal falls and Lock Structures.
1.2 Part III	Planning of the Run-of-River Projects
1.3	Project hydrology and installed capacity
1.4	Reports preparation: reconnaissance, pre-feasibility, feasibility, detailed project report, as built report
1.5	Project cost estimation
1.6	Economic & Financial Analysis and Tariff Determination
1.7	Model Contract for Execution and Supplies of Civil and E&M Works
1.8	Project Management of Small Hydroelectric Projects
1.9	Environment Impact Assessment
1.10	Performance evaluation of Small Hydro Power plants
1.11	Renovation, modernization and uprating
1.12	Site Investigations
Civil works	
2.1	Layouts of SHP projects
2.2	Hydraulic design
2.3	Structural design
2.4	Maintenance of civil works (including hydro-mechanical)
2.5	Technical specifications for Hydro Mechanical Works
Electro Mechanical works	
3.1	Selection of Turbine and Governing System
3.2	Selection of Generator
3.3	Selection of Switchyard
3.4	Monitoring, control, protection and automation
3.5	Design of Auxiliary Systems and Selection of Equipments
3.6	Technical Specifications for Procurement of Generating Equipment
3.7	Technical Specifications for Procurement of Auxiliaries
3.8	Technical Specifications for Procurement and Installation of Switchyard Equipment
3.9	Technical Specifications for monitoring, control and protection
3.10	Power Evacuation and Inter connection with Grid
3.11	Operation and maintenance of power plant
3.12	Erection Testing and Commissioning

PERSON INVOLVED

1. Dr Arun Kumar, CSO and Principal Investigator, AHEC, IIT, Roorkee
2. Dr S K Singal, SSO & Investigator, AHEC, IIT, Roorkee

Drafting Group

1. Dr B N Asthana, Consultant, New Delhi
2. Dr Arun Kumar, AHEC, IIT, Roorkee
3. Dr S K Singal, AHEC, IIT, Roorkee

Consultation Group

1. Mr. S K Tyagi, consultant, AHEC, IIT Roorkee
2. Mr. A K Chopra, Consultant, SHP, MNRE, GOI, New Delhi
3. Mr. P C Kureel, CEA, New Delhi
4. Mr. Pankaj Kulshreshtha, UJVNL, Dehradun
5. Mr. Himanshu Tiwari, UJVNL, Dehradun
6. Mr. A K Singh, UJVNL, Dehradun
7. Mr. P K Singhal, UPJVNL, Lucknow
8. Mr. U Ukhal, HPPCL, Himachal Pradesh
9. Mr Sumer Singh, Consultant, Dehradun
10. Mr Dalip Dua, MD, Krishna Hydro Projects Pvt. Ltd., Dehradun
11. Mr Shailendra Singh, AGM, THDC India Ltd., Rishikesh
12. Mr J K Varshney, Sr Manager, THDC India Ltd., Rishikesh
13. Mr A P Singh, L&T, Faridabad
14. Mr P K Yadav, L&T, Faridabad
15. Mr C Purushothaman, TANGEDCO, Chennai
16. Mr H J Patel, Consultant, Ahmedabad

CONTENTS

ITEMS		PAGE NO
Guidelines for Planning and Layouts		
1.0	Scope	1
2.0	References	1
3.0	Planning of SHP Projects	1
3.1	Estimation of Benefits	3
3.2	Selection of Type of Project	3
3.3	Desilting Measures	3
3.4	Selection of Type of Structures	3
4.0	Factors for Consideration in Planning	4
5.0	Planning Methodology – General	4
5.1	Data Collection	5
5.2	Map Studies	5
5.3	Field Visit	5
5.4	Mapping and Site Investigations	5
5.5	Conceptual Design for Layouts	5
6.0	Types of Schemes	6
7.0	Run-of-River (ROR) Schemes	6
7.1	Intake	19
7.2	Water Conductor System	19
7.3	Forebay Tank / Balancing Reservoir / Surge Tank	19
7.4	Powerhouse and Tailrace Channel	20
7.5	Cascade Development	20
7.6	In stream Run of River Schemes	20
8.0	Canal Falls and Out Fall Schemes	20
8.1	Layout of Canal Falls Schemes	24
8.2	Variants of Canal Fall Projects	24
8.3	Intake Structures	26
8.4	Water Conductor	26
8.5	Power House	26
8.6	Safety Assessment of Existing Structures	26
8.7	Interface with the Irrigation Requirement	27
9.0	Dam / Barrage/ Weir Based Schemes	27
9.1	Layout of Dam Toe Schemes	28
9.2	Intake Structure	29
9.3	Water Conductor System	29
9.4	Power House Location	34
9.5	Raising Full Reservoir Level	34
9.6	Interfacing with Irrigation Requirements	34
9.7	Safety Assessment of Existing Structures and Further Investigations	36

LIST OF FIGURES

FIGURE NO.	TITLE	PAGE NO.
1.	Flow chart for project planning	2
2.	Typical Layout of Run of River Scheme	7
3.	Typical Layout of Canal Falls	7
4.	Dam Based Outlets	8
5.	Pumped Storage Scheme	8
6.	Typical Layouts for Run of River Development in River	9
7.	Typical Layouts for Run of River Schemes	10
8.	Typical layout run of river scheme with under water conductor Shift from one Bank to other	11
9.	Typical Alternate Layouts for Water Conductor System for Run of River scheme	12
10.	Typical run of river scheme layout with tunnel – 1	13
11.	Typical run of river scheme layout with tunnel – 2	14
12.	Typical run of river scheme layout with short approach and long tail race channel	15
13.	Typical run of river scheme layout with longer tunnel compared to river length for providing adequate cover over tunnel	16
14.	Typical run of river scheme layout having several bends in the tunnel alignment	17
15.	Typical Longitudinal and Cross section of Tunnel	18
16.	Layouts for a Site with Different Types of Turbines	21
17.	Cascade Development with Storage schemes	22
18.	Cascade Development with Storage and Run of River schemes	22
19.	Cascade Development with Run of River schemes	22
20.	Typical Layout Cascade RoR Schemes with Gaps between two schemes	23
21.	Typical Alternate Layouts of Canal fall based Power Houses	25
22.	Typical Canal Intake with Power House Building	30
23.	Typical Intake on Canal Fall with Siphon intake based turbine	31
24.	Typical Layouts of Dam Toe Scheme	32
25.	Typical Layout of SHP Using Abutment of an Existing Dam	33
26.	Arrangement for New SHP (abandoning old powerhouse) on a Reservoir	35

GUIDELINES FOR PLANNING AND LAYOUTS

1.0 SCOPE

This guideline provides guidance on planning and layouts for all types of small hydropower projects by utilizing the falls and steep slopes of the natural streams as run of river, existing drops on canal falls, existing dams, barrages, weirs etc. as the water diversion or storage structures. Planning and layout of a SHP project on existing works is more complex than planning a new project on a natural stream as the design and operational details and structural soundness of the existing structures are important for the purpose of planning of a SHP. The guideline also covers the planning of small hydropower development on cooling water return channels of thermal power plants and water/waste water treatment outfall structures.

2.0 REFERENCES

- R1. IS 12800 (Part 3):1991 : Guidelines for Selection of Hydraulic Turbine, Preliminary Dimensioning and Layout of Hydroelectric Power Houses
- R2. CWC 2010 : Guidelines for preparation of detailed project report of irrigation and multipurpose projects, Central Water Commission, Govt. of India, Delhi,
- R3. CEA, 2012 : Guidelines For Formulation of Detailed Project Reports for Hydro Electric Schemes, their Acceptance And Examination for Concurrence, New Delhi
- R4. ESHA, 2004 : Guide on How to Develop a Small Hydropower Plant, European Small Hydropower Association
- R5. CEA, 1982 : Guidelines for Planning SHP
- R6. Nigam, PS, "Hydro-electric Engineering", Nem Chand & Bros, Roorkee, 1985
- R7. E Mosonyi: Water Power Development – Low Head Power Plants, Nem Chand & Bros, Vol I, Indian Edition, 2009
- R8. Tudor Engineering Company for USBR, Reconnaissance Evaluation of Small, Low – Head Hydroelectric Installations, July 01, 1980
- R9. Kumar, A., T. Schei, A. Ahenkorah, R. Caceres Rodriguez, J.-M. Devernay, M. Freitas, D. Hall, Å. Killingtveit, Z. Liu, 2011: Hydropower. In IPCC Special Report on Renewable Energy Sources and Climate Change Mitigation [O. Edenhofer, R. Pichs-Madruga, Y. Sokona, K. Seyboth, P. Matschoss, S. Kadner, T. Zwickel, P. Eickemeier, G. Hansen, S. Schlömer, C. von Stechow (eds)], Cambridge University Press, Cambridge, United Kingdom and New York, NY, USA

3.0 PLANNING OF SHP PROJECTS

Small hydropower projects are site specific and needs careful planning for project formulation and implementation. The project planning requires substantial investment in terms of time, efforts and finances to determine the feasibility of the project for execution. Proper planning depends on extent of various investigations such as topographical survey, hydrological survey, load survey, socio- economic survey, geological survey, survey on environmental & ecological aspects, materials survey and muck disposal survey as per requirement. The steps involved in planning of a SHP project are shown in Fig. 1.

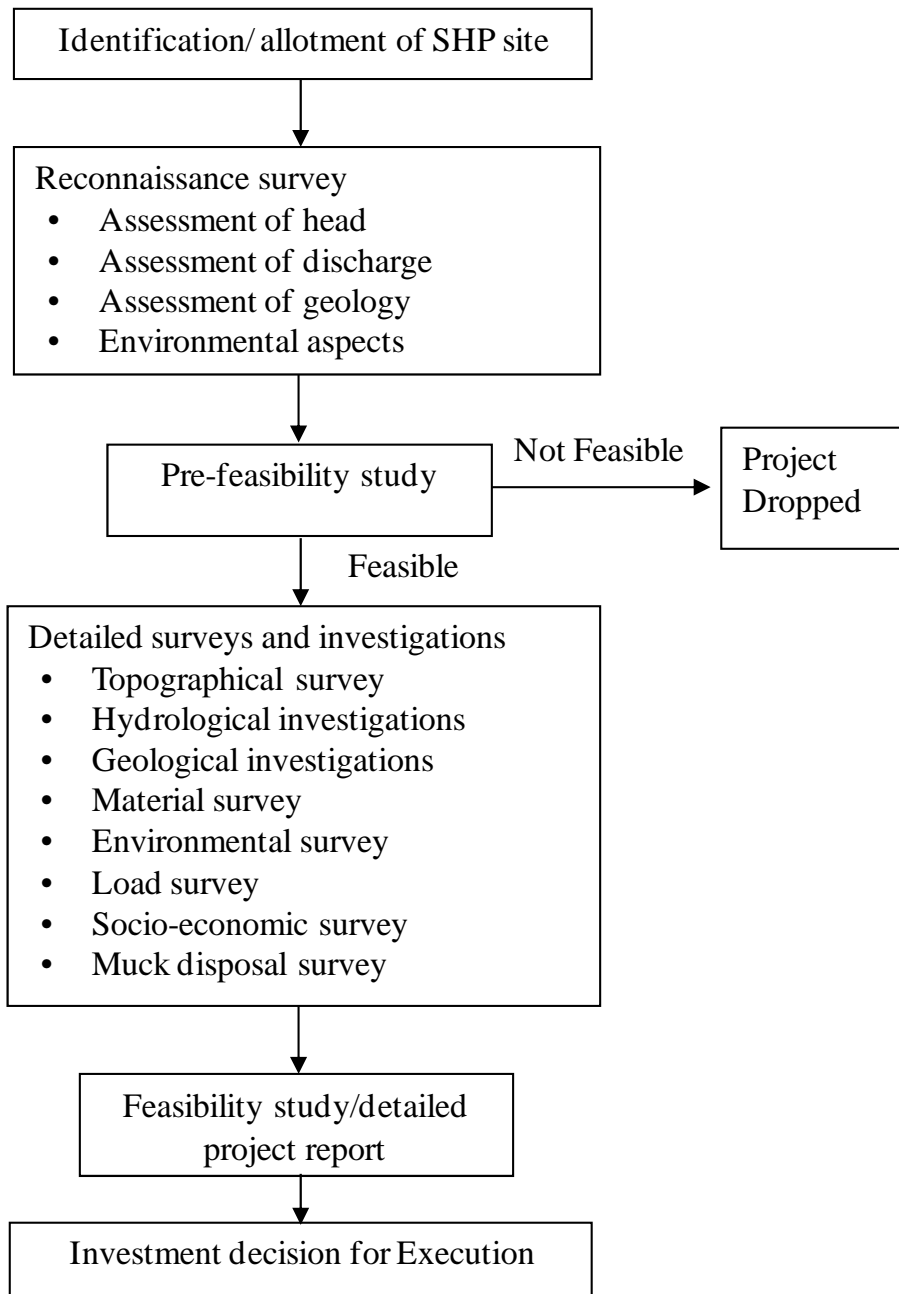

Fig. 1: Flow chart for project planning

The planning of a SHP project is carried out in two stages. In the first stage, prefeasibility study is carried out based on the data collected/ surveyed on topography, hydrology, geology and constraints/barriers faced during reconnaissance survey of the project area to assess the technical feasibility of the project. The project found non-feasible is dropped and only feasible projects are taken up for second stage study. In the second stage, based on the detailed surveys and investigations of the project area, detailed project / feasibility study is carried out and detailed project report (DPR)/Feasibility Report (FR) are prepared to assess the technical feasibility as well as financial viability of the project. Technically feasible and financially viable projects are considered for execution unless the projects are to be developed for social considerations.

While planning a SHP project, the important aspects are (i) estimation of benefits, (ii) selection of type of project, (iii) desilting measures, (iv) selection of type of structures, (v) selection of type of E&M equipment and (vi) Power evacuation/utilization.

3.1 Estimation of Benefits

Benefits from a SHP are annual energy generation which depends on estimation of water availability. Sometimes, observed discharge data at the project diversion site are not available. In such cases, the estimation of water availability at project site is worked out by indirect methods. Selection of indirect method depends on the location and extent of discharge and rainfall data availability. The planning and selection of installed capacity, unit size and number of units is based on economy and maximization of energy generation. Standard / manual / guideline on hydrology and installed capacity (no. 1.3) can be referred for the same.

3.2 Selection of Type of Project

The SHP projects are run of river (ROR), canal falls, dam toe and instream types. Run of river are with or without pondage for diurnal variation of discharge. The projects with pondage are operated for peaking purpose during the periods when river discharge is low. Pondage can be planned either by high head gates on a barrage or diversion weir at diversion site on stream itself or by constructing a balancing reservoir enroute of water conductor system, provided topography permits. Projects without pondage operate on the discharge as and when available from the source. The selection of the type of project depends on the site conditions, topography, geology and the economy. For projects without pondage, the unit size is so planned as to operate at the minimum discharge available.

3.3 Desilting Measures

Provision of desilting measures is important particularly for run of river (ROR) projects. It is of major concern when located on Himalayan Rivers. Himalayan rivers carry lot of sediment during monsoon which if allowed passing through the turbine causes serious erosion to the turbine blades and other underwater parts of the generating unit. In some cases, runners are found completely eroded even after one season of operation. Investigations have shown that erosion is directly proportional to sediment characteristics such as concentration, size, shape and hardness. Hence during planning of the project, these sediment characteristics should be determined by sampling and laboratory testing. Considering the head on the turbine, sediment characteristics and the expected erosion, desilting measures should be planned.

3.4 Selection of Type of Structures

In SHP projects, the selection of type of structures should be such that local available construction material and labour be used optimally to make the project economical. In diversion structure, stone masonry in place of reinforced cement concrete (RCC) should be used as much as possible. Depending on site conditions like topography, geology and the economy, the selection between channel, pipe and tunnel is made judiciously. Channel can be made of stone masonry with or without shotcreting or concrete lining on inner surface to prevent leakage/seepage. If channel alignment has much longer length than tunnel, a large number of drainage crossings and slips and landslides are expected to disrupt the operation, then the choice may be for a tunnel which may be free flow or under pressure. Sometime a

low pressure pipe is chosen in place of a open channel for operation and maintenance ease. The long pressure tunnel/pipe would need a surge tank at the end whereas for free open channel a forebay is required at the end of free flow channel/ pipe. A large diameter steel pipe laid on the hill slope can also serve the purpose of surge tank. An exposed penstock from surge tank/ forebay to power house building be preferred is normally adopted unless other favorable local conditions exist for embedded or buried penstock. It can be bifurcated or trifurcated near the power house. In case length is short, separate penstock for each unit may be preferred.

4.0 FACTORS FOR CONSIDERATION IN PLANNING

4.1 The following river characteristics favour the development of economic layouts of ROR SHP projects:

- a) Steep slopes of rivers
- b) Rapids and waterfalls
- c) Canyons and narrow valleys
- d) Major river bends

4.2 The following structures (new or existing) can be used for SHP development

- e) Canal falls and outfalls
- f) Barrages/weirs/navigation locks
- g) Cooling water return channels
- h) Existing dam outlets and spillways

4.3 In the planning of a SHP project following site specific conditions should be considered:

- Meteorological data such as temperature, wind velocity, rainfall etc.
- High flood water levels in the river
- Area geology, foundation conditions and slope stability
- Condition of main road to the area, weight and width limitations on bridges.
- Access to site and space for structures and site roads.
- Availability of construction materials (sand, aggregates and impermeable fill, as required)
- Local manpower, services and skills availability
- Power evacuation

5.0 PLANNING METHODOLOGY – GENERAL

It involves the identification of all practical alternative layouts of the project and the evaluation of such alternatives in order to determine the conceptual design of viable layout. If the selected design appears economically viable, then more detailed feasibility studies need to be undertaken for the selected layout. The recommended methodology includes the following sequential steps:

- Data Collection
- Map studies
- Field visit
- Mapping and site geotechnical investigations
- Conceptual design
- Economic evaluation
- Report on preliminary studies

5.1 Data Collection

All available maps and documents including site or regional hydrology data, topographical maps, geological maps, previous planning studies including power potential, power demand (off grid and grid) surveys, site photographs, socio economy survey reports should be collected and analysed for further investigations.

5.2 Map Studies

Based on the analysis of available data, potential development schemes should then be laid out on available maps for guidance during the field visit. It is further recommended that an outline of preliminary studies report be made at this stage and a check list be prepared before going into the field. This will help to establish the required important information which is lacking in order to obtain it during the field visit.

5.3 Field Visit

The field visit provides an opportunity to have an appreciation of site conditions, topography, flow regime, geology, infra structure available, access roads and transmission lines. From these on-site observations, it is often possible to identify practical locations for temporary facilities, head-works, desilting tank, water conductor system and powerhouse and to decide the location of diversion on the river and best suited alignment for routing of the waterways, preliminary access roads and transmission lines routes. These locations, their elevations and co-ordinates can be determined with portable GPS or other available instrument. Preferably the inspection team should include at least three professionals: a hydrologist, a geologist and a hydropower engineer along with local representatives whose practical knowledge about the area could be invaluable. Typically, a field visit may require 1 to 3 days depending on the remoteness, size and complexity of the site. Field visit should be supplemented with photographs and a field inspection report.

5.4 Mapping and Site Investigations

The scope of the mapping and site investigation programs should be prepared following the field visit. The extent of the mapping should be sufficient to cover all the alternatives envisaged and to allow for reasonable adjustments (re-alignments) of structures, waterways, access roads and transmission lines routes. The surveyors should also record ground conditions on their maps, such as: grass land, sparse or heavy forest, deep soil, broken rock or solid bed rock. Site investigations shall include collection of the sand and rock samples to test for suitability for concrete production. Drilling, geological mapping and (possibly) seismic surveys may also be required, as recommended in Standard/Manual/Guideline no. 1.12.

5.5 Conceptual Design

At this stage, preliminary designs and cost estimates are prepared for each alternative layout and benefits are evaluated. The relative merits of each alternative are assessed by economic analysis including environmental concerns to determine the best alternative. Careful attention should be paid to the cost components which vary from one alternative to the other. Feasibility study / detailed project report is carried out for the selected layout of the scheme.

6.0 TYPES OF SCHEMES

The most common small hydro projects are of the following types:

- Run of river (Fig. 2)
- Canal falls (Fig. 3)
- Dam based outlets and spillways (Fig. 4)
- Pumped storage (Fig. 5)
- In stream (Fig. 6)

7.0 RUN-OF-RIVER (ROR) SCHEMES

A typical ROR project would normally comprise:

- Diversion structure and intake (head works)
- Intake channel/tunnel
- Desilting tank
- Power channel / power tunnel
- Forebay tank / surge tank with spilling arrangement / balancing reservoir
- Penstock
- Powerhouse
- Tailrace channel
- Access road (ropeway)
- Operators residences (optional)

A ROR scheme may have various layouts as may be seen in Fig. 7. Run of river scheme may also have layouts where water is diverted from one bank, to other bank through aqueduct and if required shifted again on original bank as may be seen in Fig. 8.

For a topography and geology, open channel (conductor) on the surface or a tunnel or a combination of both may be opted depending on economy of channel or tunnel is illustrated in Fig. 9. Different layouts for run of river schemes with tunnel based layouts installed recently may be seen in Fig. 10, 11, 12, 13 and 14. The typical section of a tunnel along with L – section opted for a project may be seen in Fig. 15.

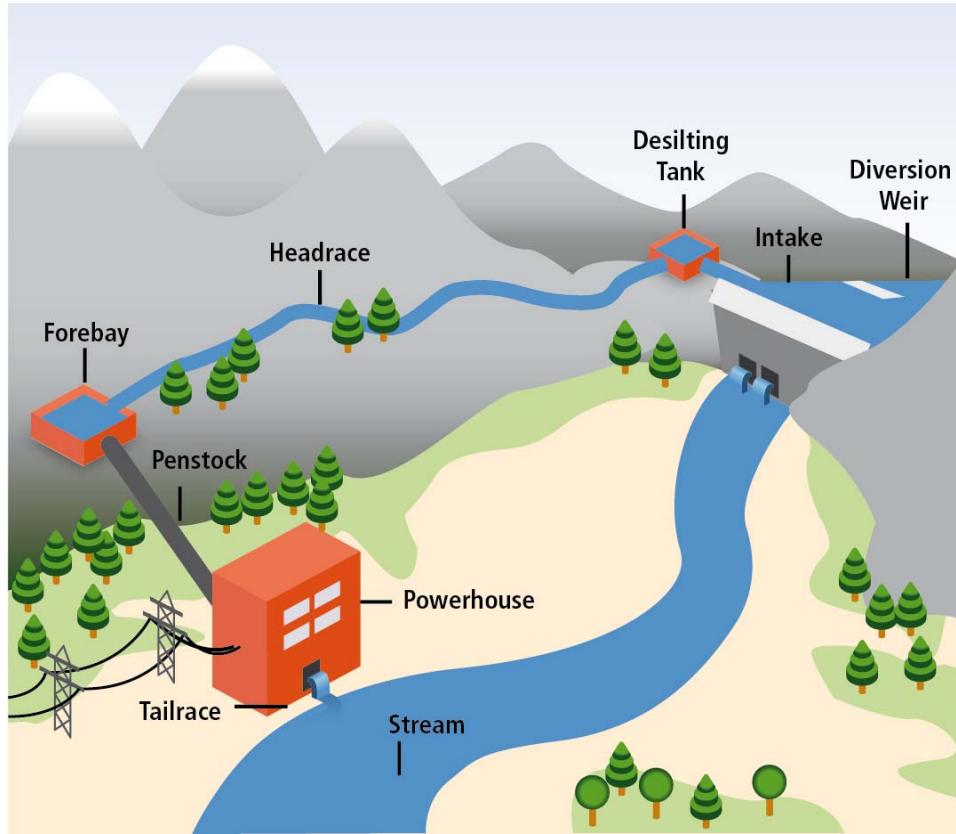

Fig. 2: Typical Layout of Run of River Scheme

(Source: Kumar, A et.al, 2011: Hydropower. In IPCC Special Report on Renewable Energy Sources and Climate Change Mitigation, Cambridge University Press)

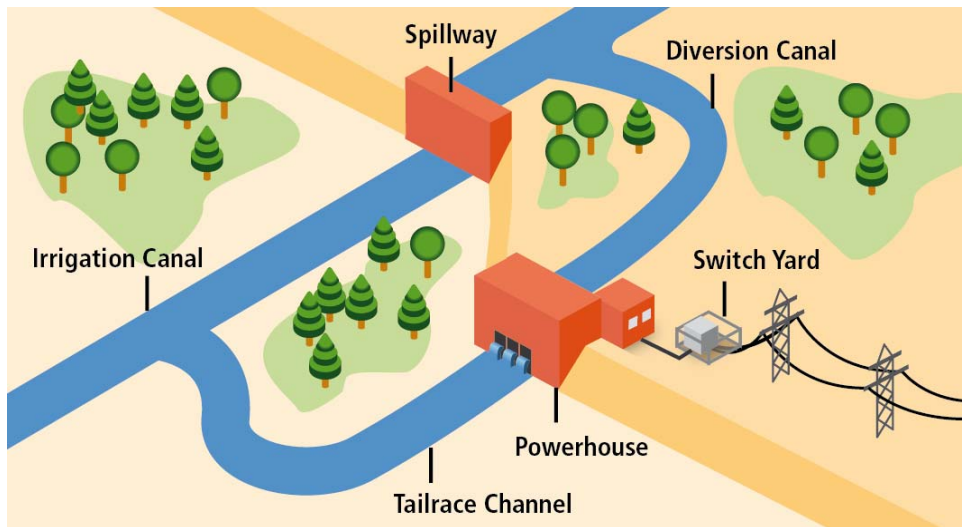

Fig. 3: Typical Layout of Canal Falls

(Source: Kumar, A et.al, 2011: Hydropower. In IPCC Special Report on Renewable Energy Sources and Climate Change Mitigation, Cambridge University Press)

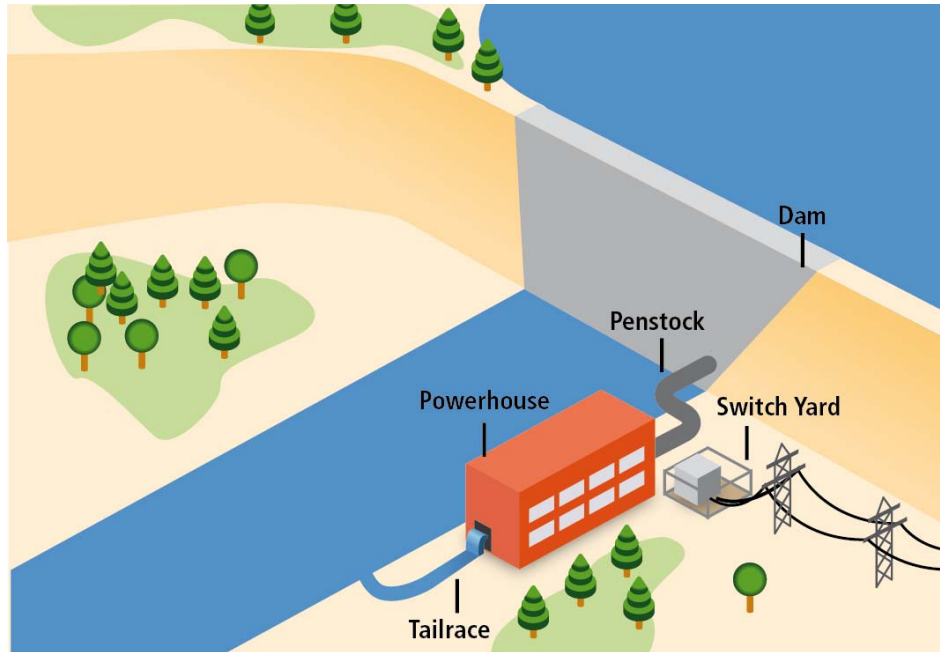

Fig. 4: Dam Based Outlets

(Source: Kumar, A et.al, 2011: Hydropower in IPCC Special Report on Renewable Energy Sources and Climate Change Mitigation, Cambridge University Press)

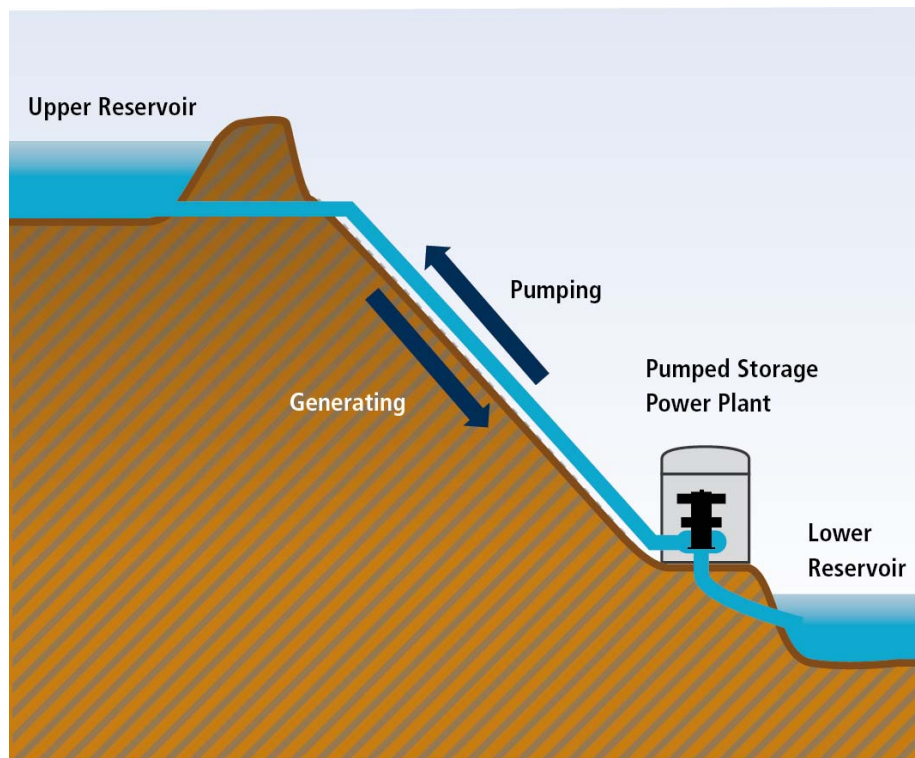
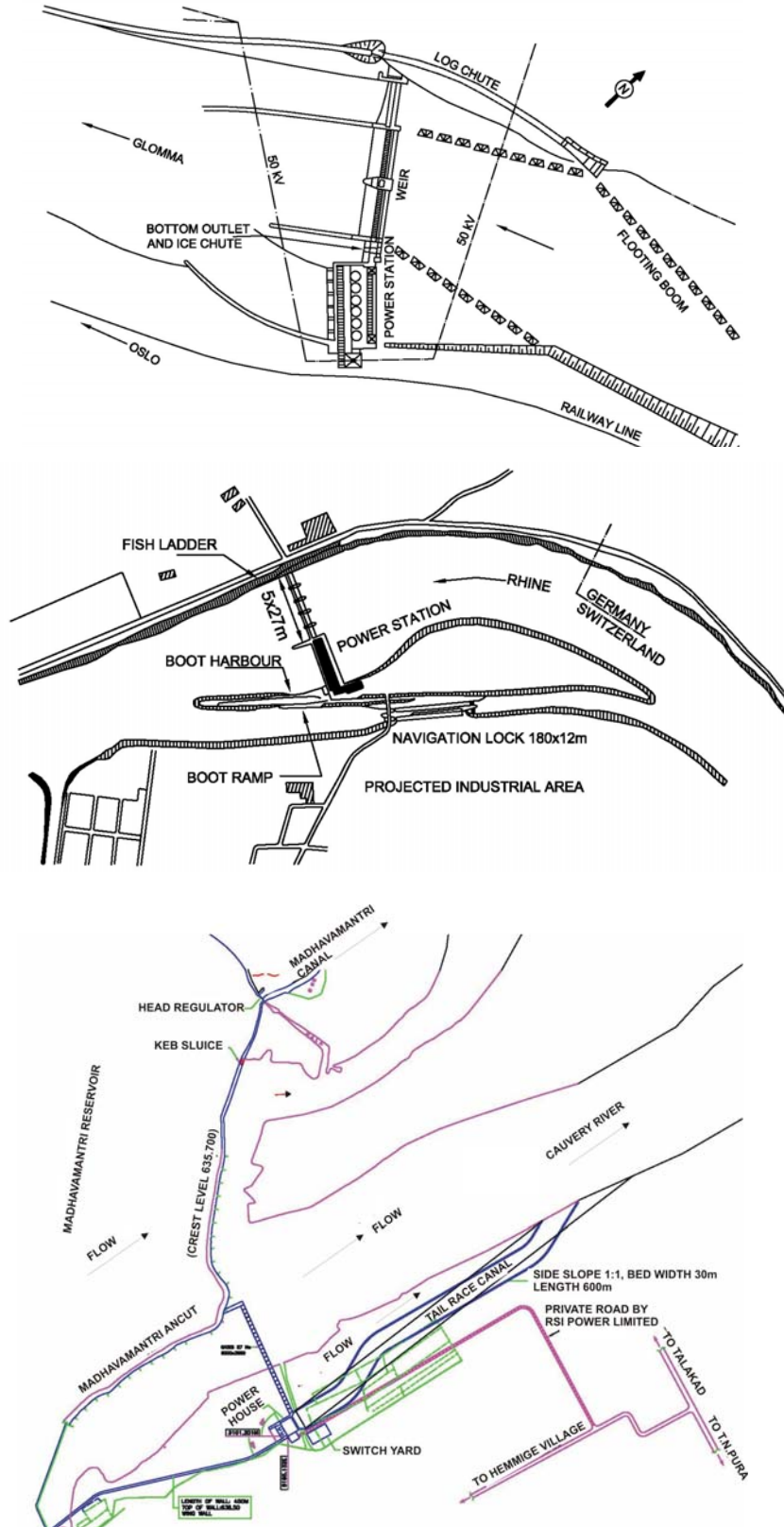

Fig. 5: Pumped Storage Scheme

(Source: Kumar, A et.al, 2011: Hydropower in IPCC Special Report on Renewable Energy Sources and Climate Change Mitigation, Cambridge University Press)



**Fig. 6: Typical Layout for Run of River Development in River
(Adopted from E Mosonyi: Water Power Development – Low Head Power Plants)**

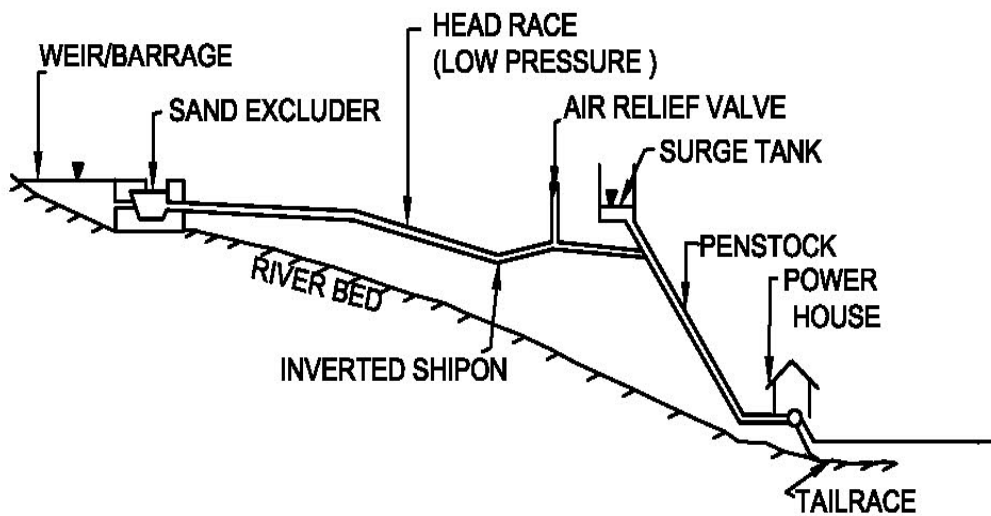
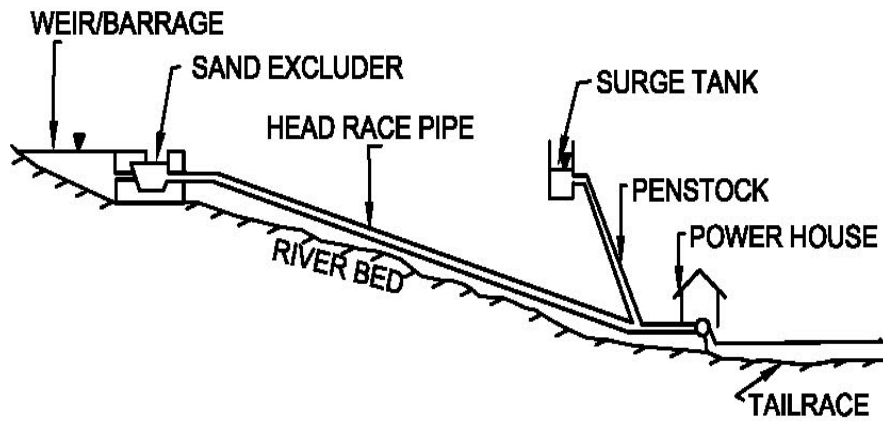
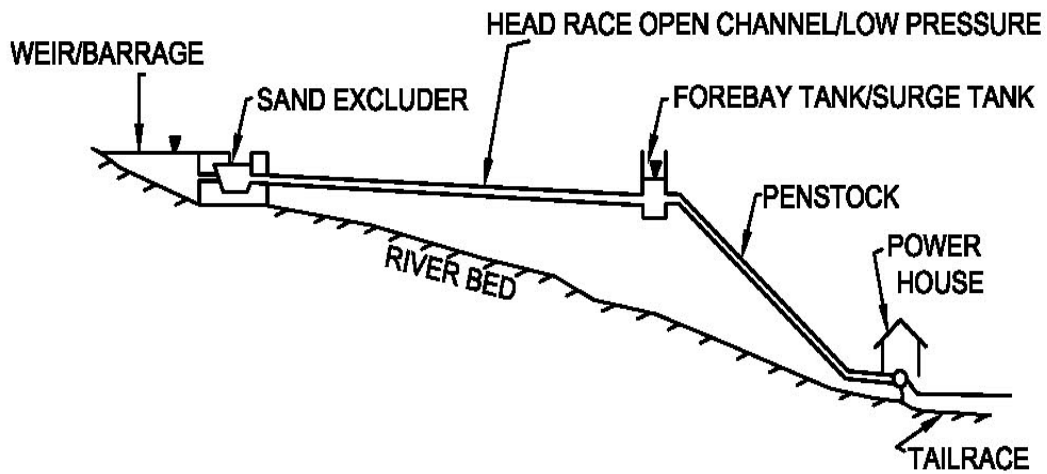

Fig. 7: Typical Layouts for Run of River Schemes

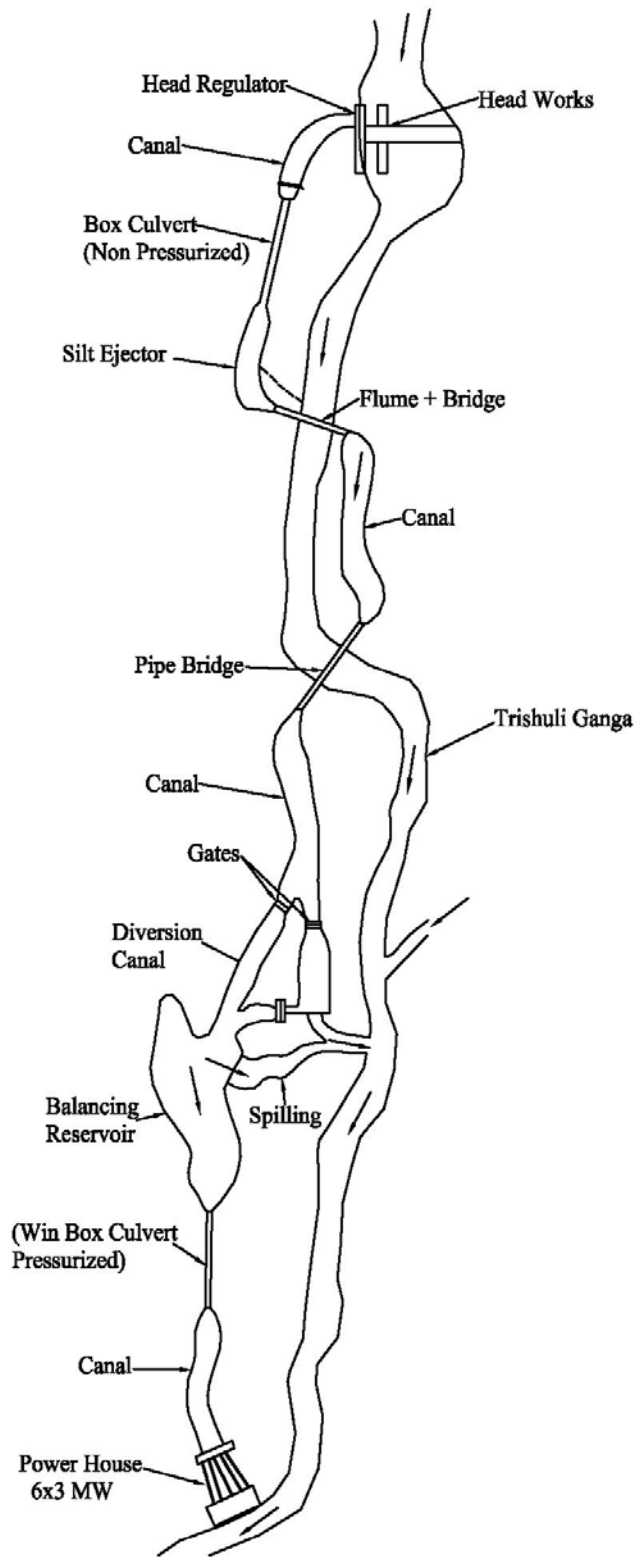
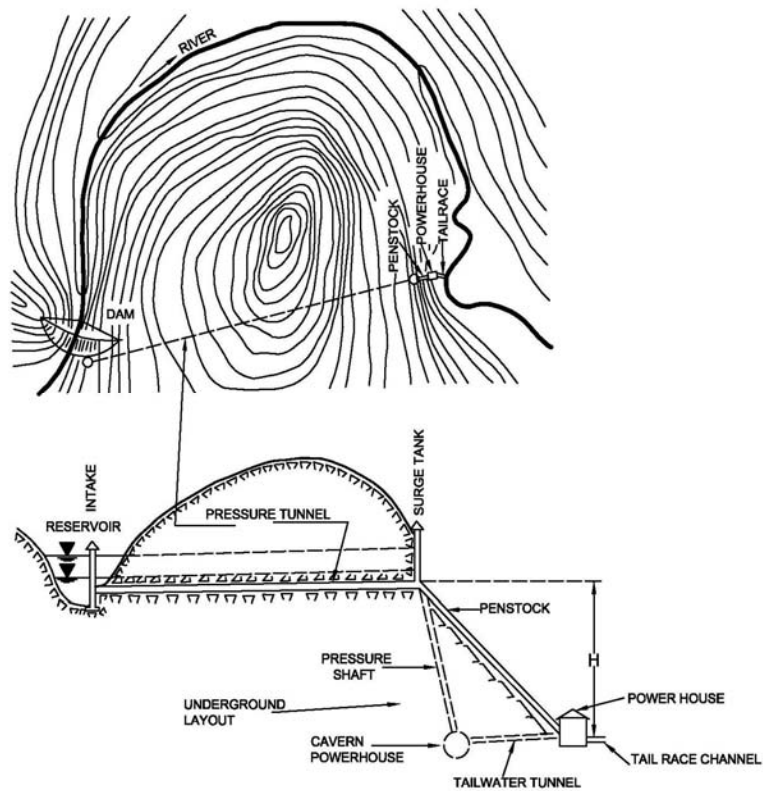
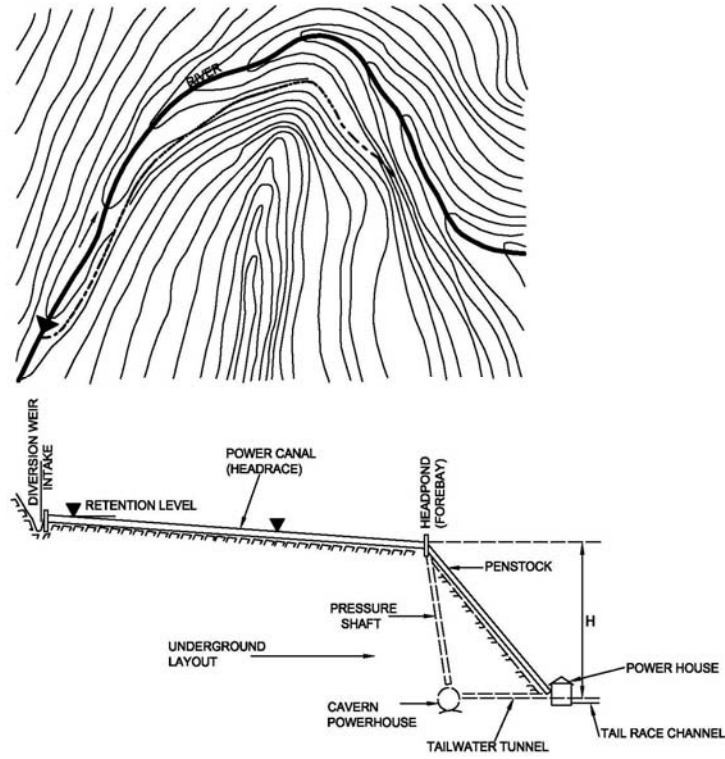

Fig. 8: Typical Layout Run of River Scheme With under Water Conductor Shift from One Bank to Other



**Fig. 9: Typical Alternate Layouts for Water Conductor System for Run of River Schemes
(Adopted from E Mosonyi: Water Power Development – Low Head Power Plants)**



Fig. 10: Typical Run of River Scheme Layout With Tunnel - 1

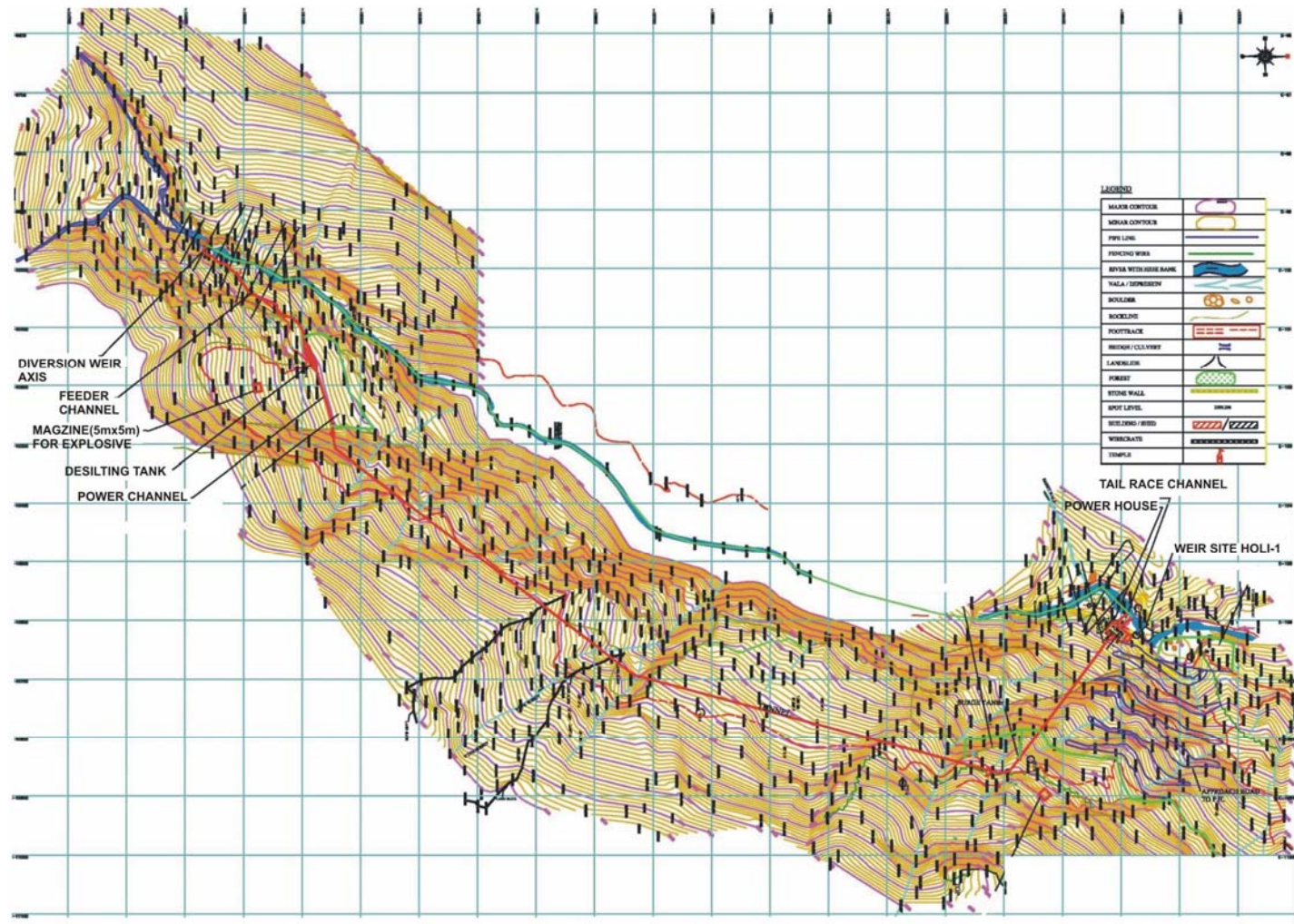
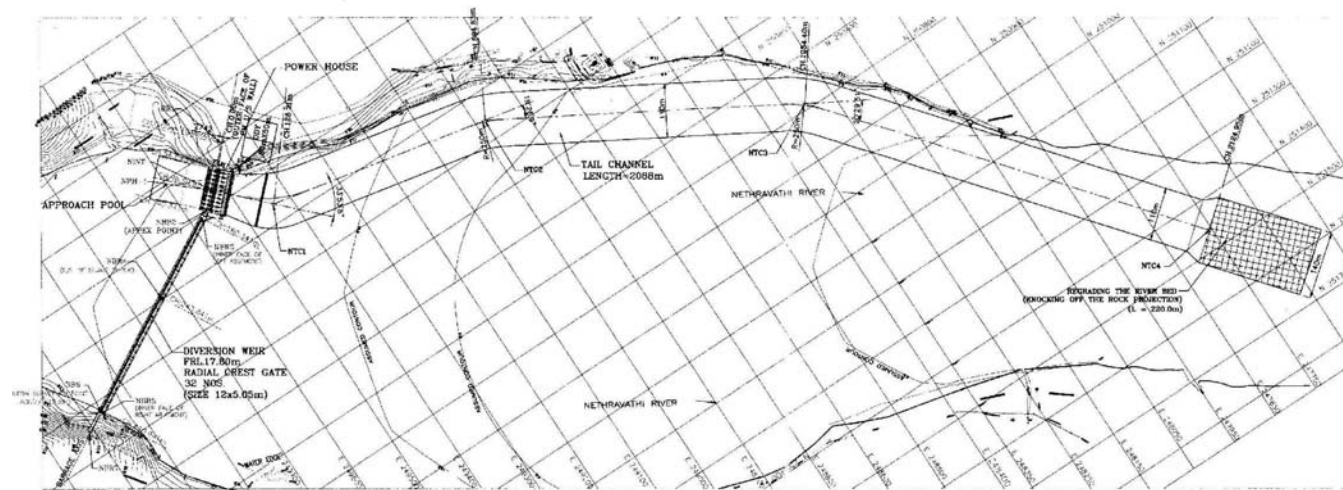
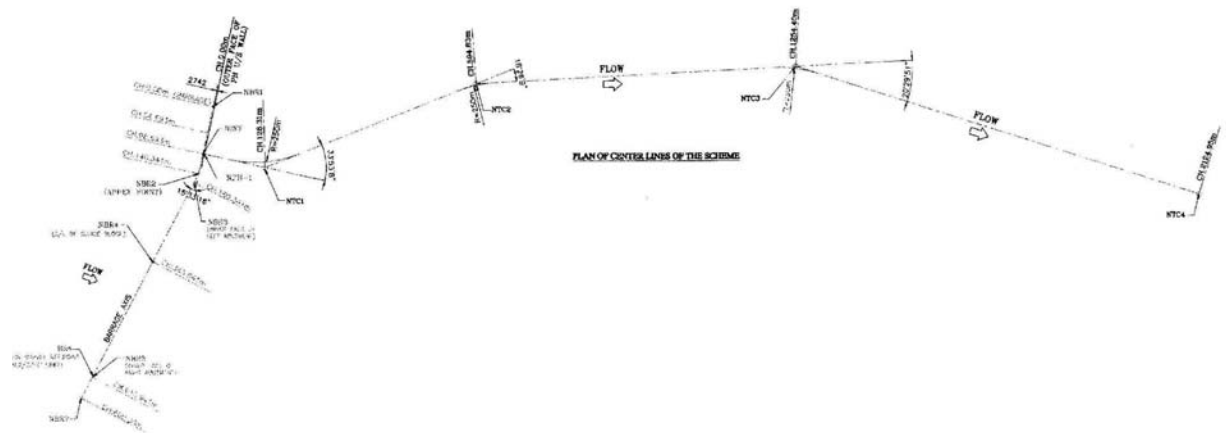

Fig. 11: Typical run of river scheme layout with tunnel – 2



PLAN OF THE SCHEME



PLAN OF CRITERIA LINES OF THE SCHEME

Fig. 12: Typical run of river scheme layout with short approach and long tail race channel

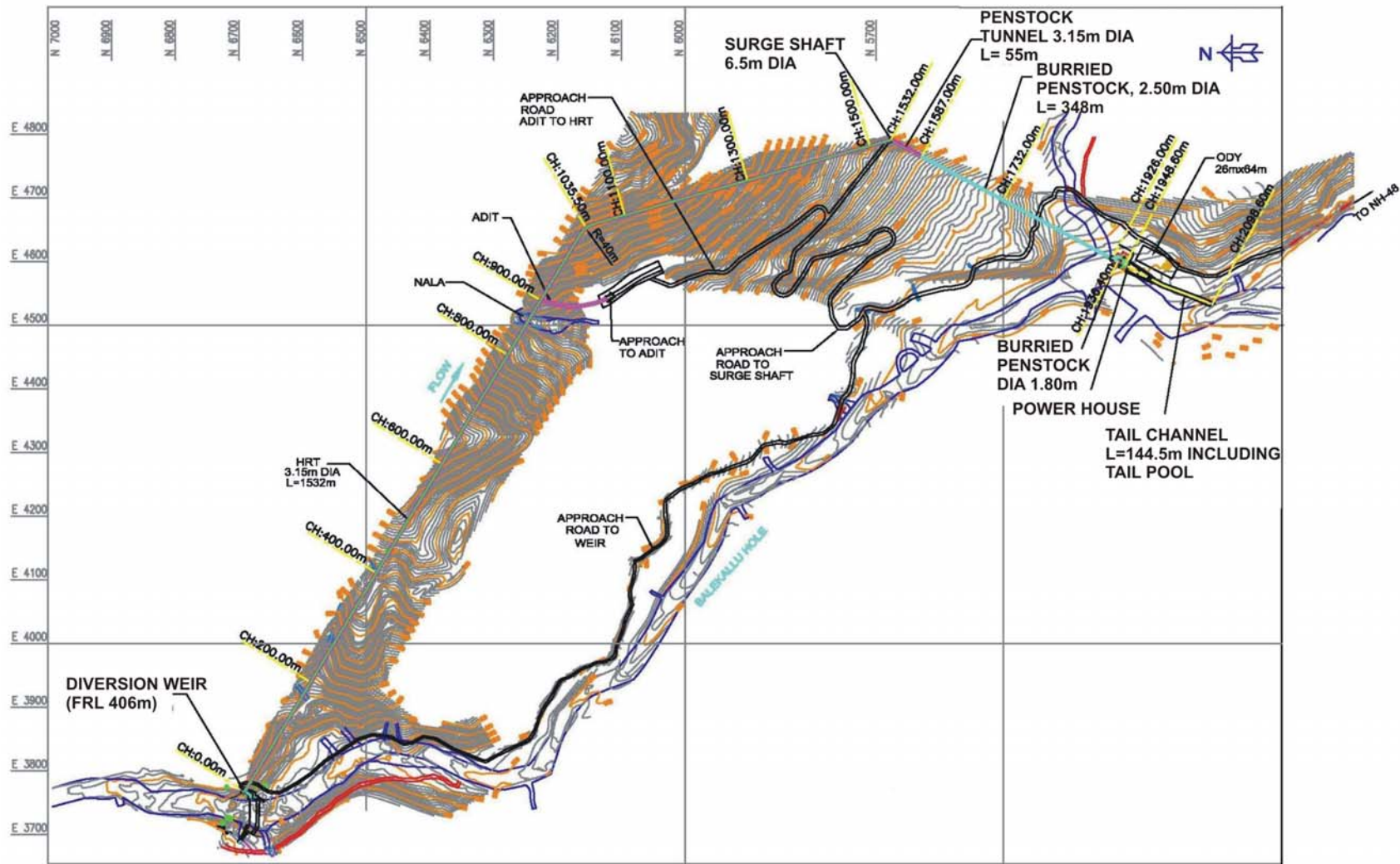

Fig. 13: Typical run of river scheme layout with longer tunnel compared to river length for providing adequate cover over tunnel

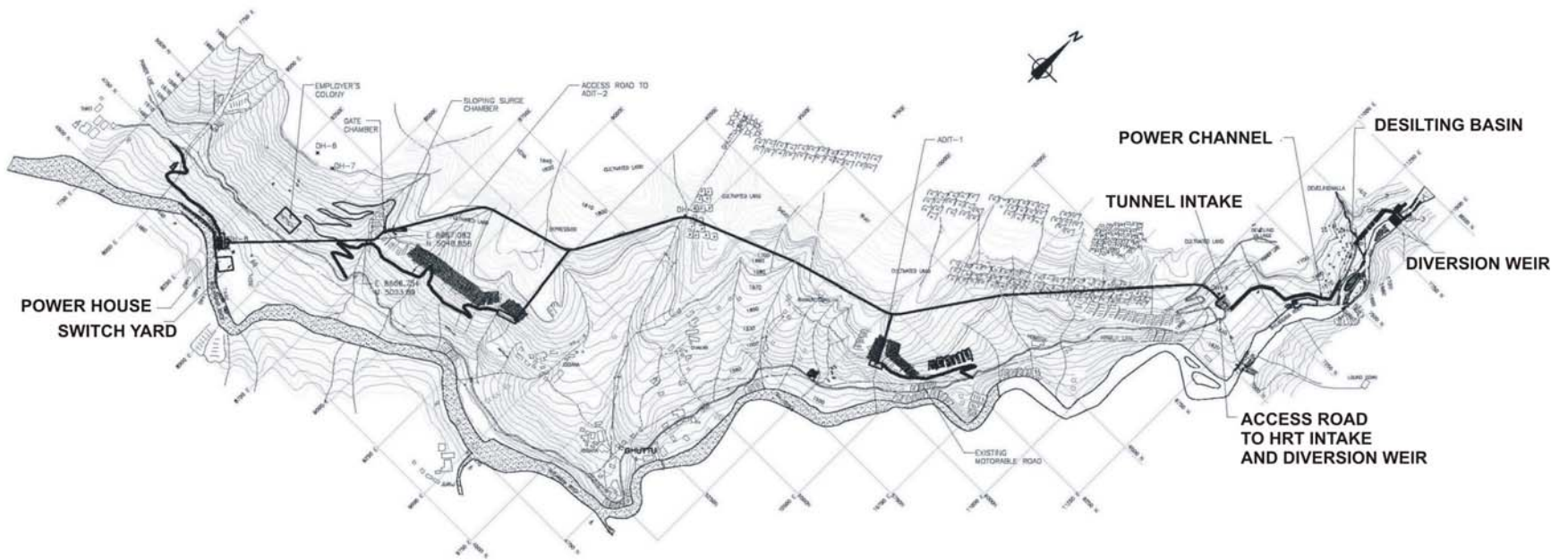
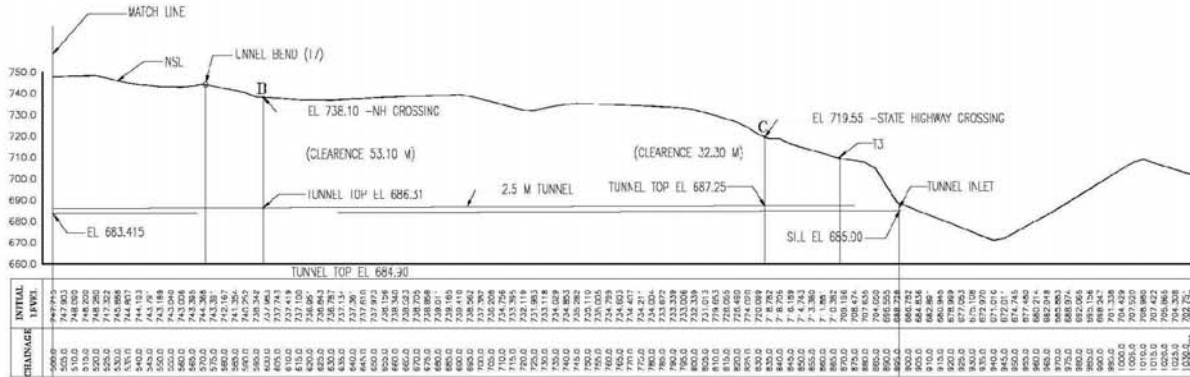
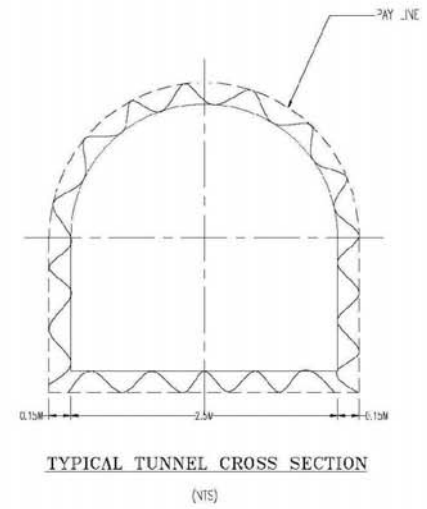
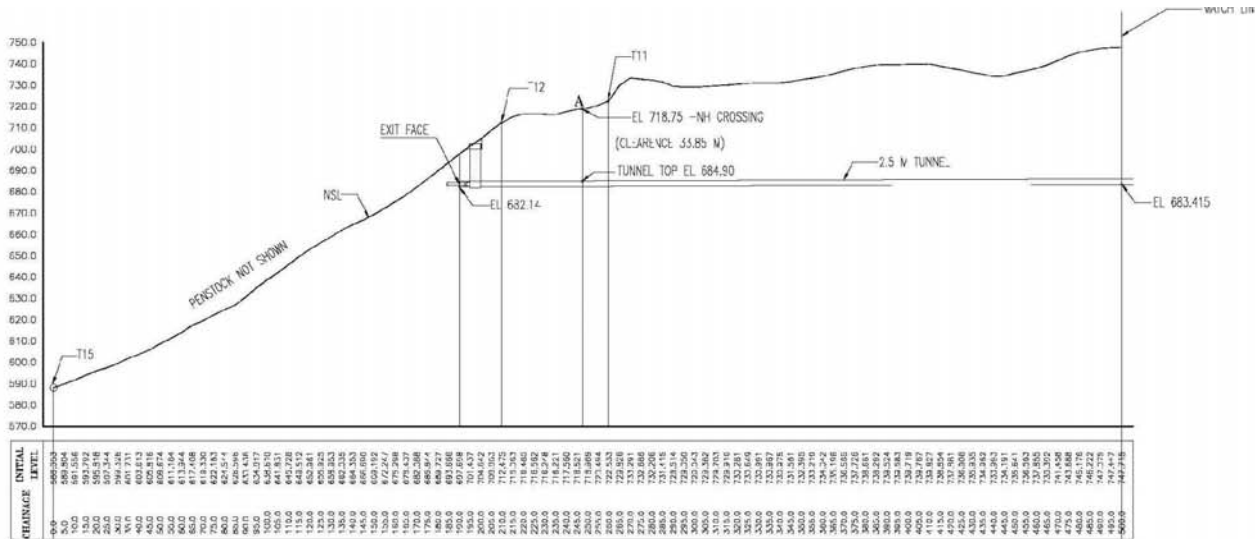

Fig. 14: Typical run of river scheme layout having several bends in the tunnel alignment



L SECTION OF TUNNEL

Fig. 15: Typical Longitudinal and Cross section of Tunnel

7.1 Intake

Raised crest or trench (also known as Tyrolean or bottom intake) intakes are generally suitable for low head diversions (details may be seen in standard no. 2.2 and 2.3). Raised intakes would be favored on relatively narrow rivers for medium to large flows ($5\text{m}^3/\text{s}$ and above). Trench intakes would be favoured in relatively steep rivers (more than 1 in 20) for flows up to about $10 - 15\text{m}^3/\text{s}$, at which point a lateral flow design should be considered.

7.2 Water Conductor System

If the diverted water carries a substantial sediment load (say more than 200 parts per million i.e. ppm on average) a desilting arrangement would be required. Preferably, the desilting arrangement should be planned as close to the diversion/ intake as possible, where relatively flat land can be found. The silt flushing outlets from desilting devices should flush the silt laden water in the drain / river above the high flood level. The waterways upstream of the desilting tank should be designed for discharge required for turbines design operation plus silt flushing flows in a manner that no silt is deposited. The water conductor system should be a lined canal, however, depending on site conditions, portions of the water conductor system may be planned as box culverts, tunnels, aqueducts, pipelines or inverted siphons.

7.3 Forebay Tank / Balancing Reservoir / Surge Tank

The layout of the forebay tank is governed by topographical and geological conditions of the site and its appurtenances such as spillway, silt sluices and head race channel. However, the site of the forebay and power house should be so selected that the penstock has minimum length. It provides small storage of few minutes to supply water to turbines when started after closure till the flow is accelerated in water conductor. It also serves as a final settling basin, where any floating debris either passed through the intake or swept into the canal be removed before the water passes to the turbine.

Sometimes balancing reservoir is provided in place of / in addition to the forebay. Thus balancing reservoir is a forebay with relatively larger storage for few hours on diurnal basis. The balancing reservoir is considered particularly in the area where water in lean season is not sufficient to operate a turbine to get the desired power.

In run of river schemes, particularly high head schemes, surge tank is provided at the junction of headrace tunnel / pressure conduit and the penstock. The surge tank is provided to absorb the water hammer or elastic shock waves coming from the penstock as a result of hydraulic transient conditions during load rejection or acceptance by the turbines and also to supply / store additional water during load demand / rejection until the pressure conduit velocity has accelerated / decelerated to the new steady state condition. Surge tank is generally provided in the projects where ratio of the length of the penstock to the head is five or more. It shall be as near to power house as possible and to a higher elevation.

An escape/ spill channel is provided in the forebay to pass the excess flow. The flow becomes excess when power demand is reduced or stopped due to load/grid failure. The excess flow is discharged into the main river or nearby stream through an open channel or pipe. The junction of escape channel / pipe with the stream should be protected from erosion and proper energy dissipation arrangement should be provided.

7.4 Powerhouse and Tailrace Channel

Preliminary powerhouse layout requires the selection of appropriate generating equipment and estimation of the main powerhouse dimensions. Using these basic dimensions, preliminary powerhouse layouts can be prepared. The details for dimensions are given in standard / manual / guidelines in 2.2 and 2.4.

For a typical site, the power house layout may vary as per the type of turbines. This may be seen typically in Fig. 16.

7.5 Cascade Development

Run of river scheme may also be developed in cascade where reservoir in combination with run of river in (Fig. 17) dams (Fig. 18) or dam with run of river or only dams (Fig. 19) are planned. Such schemes are often part of integrated development of natural streams covering irrigation, drinking water and power use. Scheme may also be developed by providing gap between two schemes as shown in Fig. 20.

7.6 In stream Run of River Schemes

Run of river schemes are also planned in the river itself by with or without creating a barrage. A typical in stream run of river development may be seen in Fig. 6.

8.0 CANAL FALLS AND OUT FALL SCHEMES

Canal falls are provided along a canal, where the level of the canal needs to be stepped-down as a fall structure to match with normal ground elevations. Although the potential heads available at such structures are small (0.5 m to 15.0 m), the energy potentials may be significant due to the large and dependable flows. In India, there are large numbers of irrigation canals and there are quite good number of falls on these canals. Many of these falls have been harnessed for hydro power generation in the past and many more projects are still in planning and construction stage. Such falls are also available on cooling water return channels on thermal power stations, drinking water and sewage channel after treatment. These schemes are easy to plan due to assured discharge and to construct because these are easily accessible and located mostly in plains. Such projects should be planned subject to the following constraints:

- New powerhouse should be constructed without interfering (or with minimum interference) of irrigation / drinking water system's day-to-day operations.
- That the hydropower scheme should not jeopardize the safety of the existing structures.

Some time, head can be increased by combining a number of falls for SHP development, if those exist within short distance.

A typical canal fall scheme would normally comprise of;

- A bypass canal with or without regulating structure,
- Compact intake cum power house and
- Tailrace canal rejoining the canal downstream the existing fall structure.

All canal fall projects must include provision for bypassing design flow so that existing flows can be maintained in the downstream during periods when the plant may be out of service or on part operation.

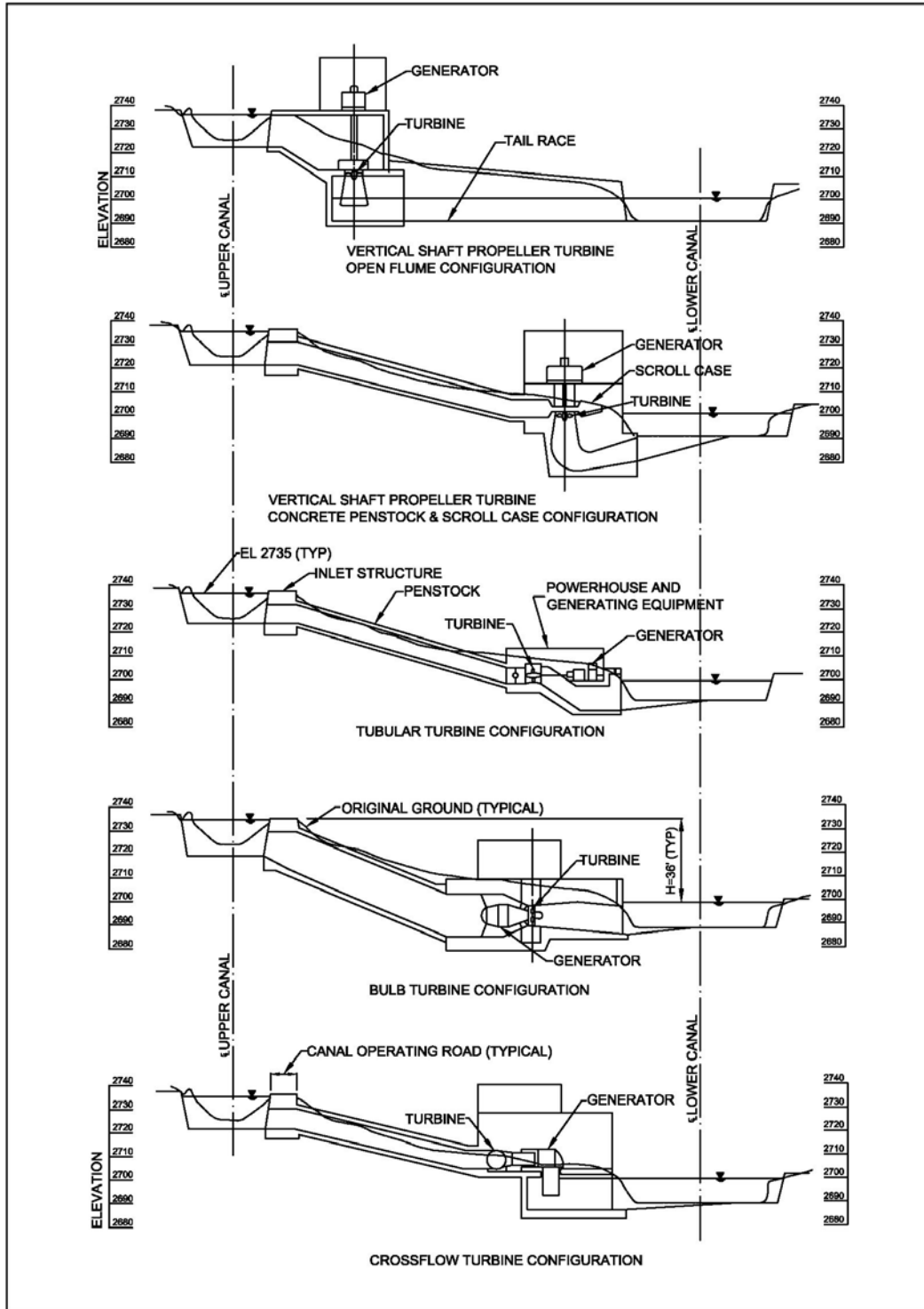

Fig. 16: Layouts for a Site with Different Types of Turbines
 (Adopted from Tudor Engineering Company for USBR, Reconnaissance Evaluation of Small, Low – Head Hydroelectric Installations)

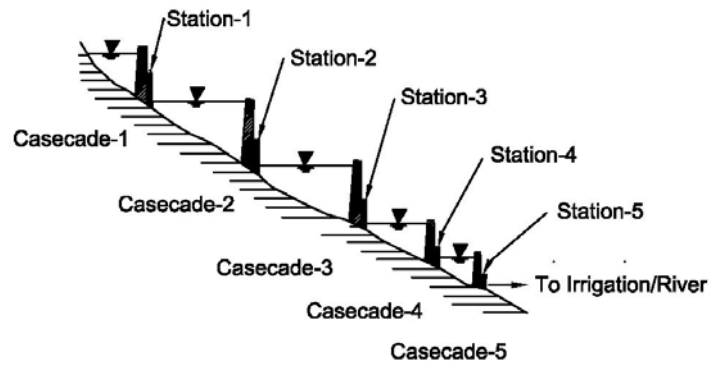

Fig. 17: Cascade Development with Storage schemes
 (Adopted from E Mosonyi: Water Power Development – Low Head Power Plants)

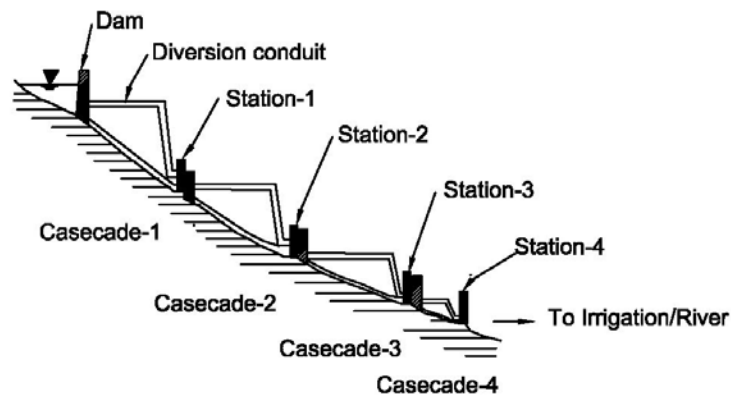

Fig. 18: Cascade Development with Storage and Run of River schemes
 (Adopted from E Mosonyi: Water Power Development – Low Head Power Plants)

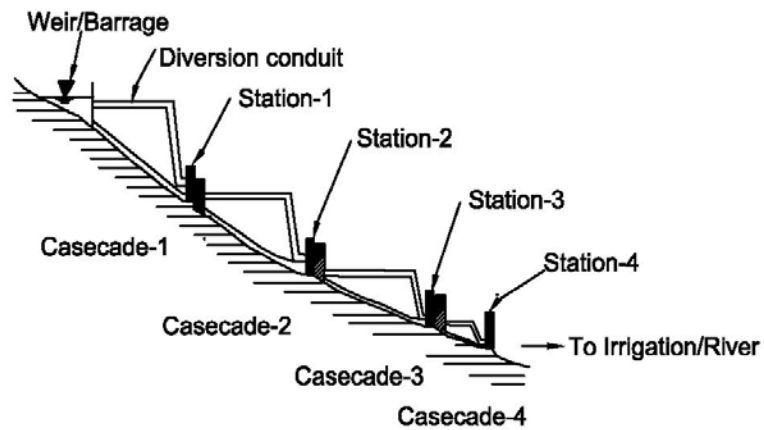

Fig. 19: Cascade Development with Run of River schemes
 (Adopted from E Mosonyi: Water Power Development – Low Head Power Plants)

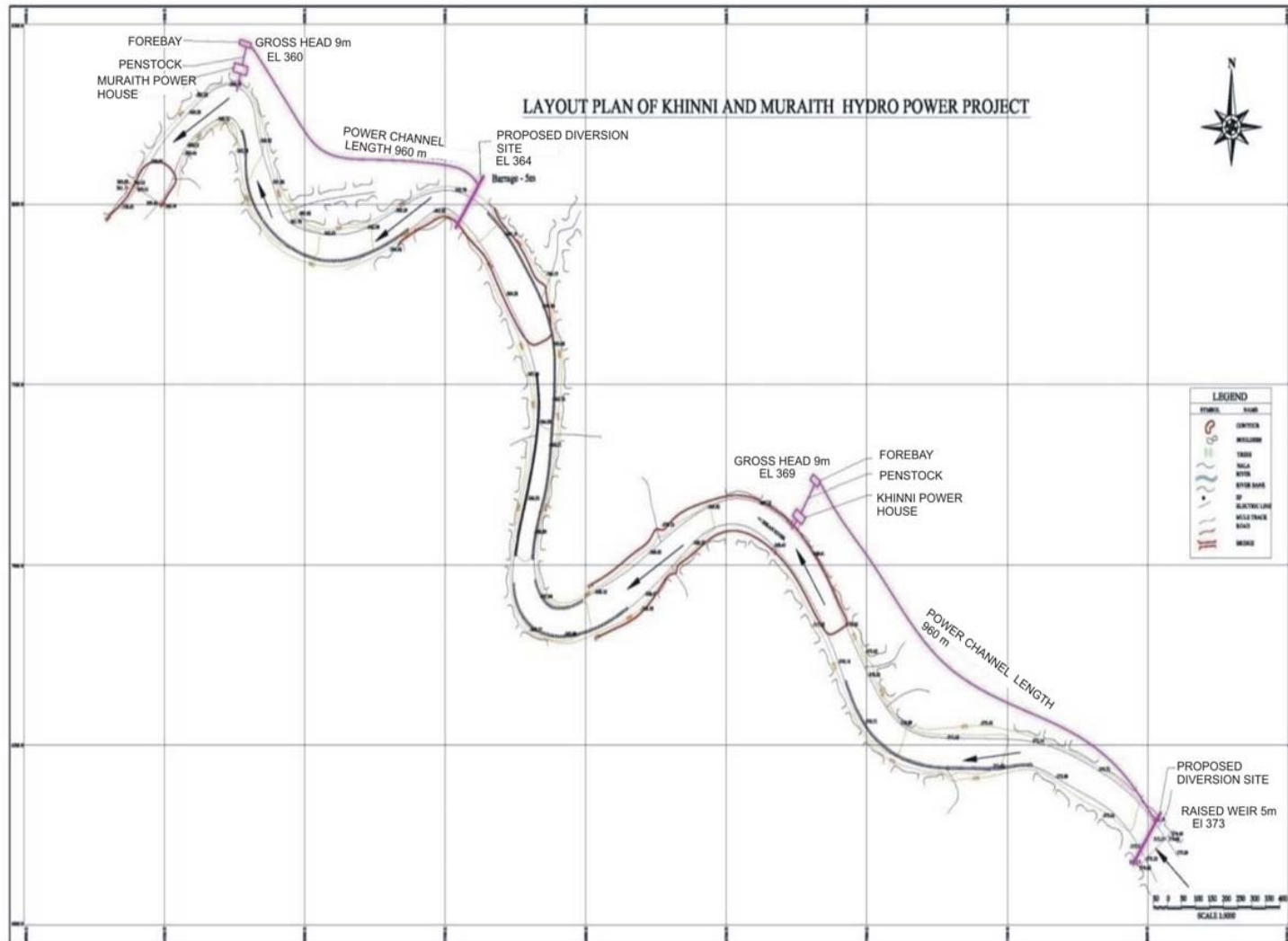

Fig. 20: Typical Layout Cascade RoR Schemes with gaps between two schemes

8.1 Layout of Canal Falls Schemes

There are rarely more than two alternatives for development depending on which side of the existing canal the diversion canal and powerhouse would be located. Practical considerations regarding foundation conditions, access, existing off taking distribution and availability of land decide the optimal arrangement. Cofferdams may be needed for facilitating interconnection of the canals. This usually happens during annual or planned closure of the canal. Attention must also be paid in hydraulic design to minimize the head losses in diversion channel.

The fixation of design discharge for such schemes depends on the operation pattern of canals which generally run according to the water availability and the irrigation requirement. In such schemes therefore, the first priority is irrigation and power generation secondary. Some canals run throughout the year but with varying discharges, and some canals are seasonal i.e. for some months of the year they remain closed. In such cases the economics of power generation should be carefully assessed at the planning stage.

8.2 Variants of Canal Fall Projects

The variant of canal fall projects depends on the location of the fall as well as the type of canal i.e. whether the canal is old canal or new canal.

For the old canal, if the fall exists at some distance from the canal head, the power house is located on a new bypass channel. The typical layout is shown in Fig. 21(a). In case few falls are combined, the power house is again located on a new bypass channel preferably at the location of the last fall as shown in Fig. 21(b).

For the under construction new canal, the power house may be located in the canal bed itself. In such case, the channel width may be increased, if required, to accommodate the power house and the bypass arrangements as shown in Fig. 21(c).

In some cases, the falls/drops may be available at the head regulator of branch canal which may be harnessed for power generation. In such situation, a link bypass be made to connect the main canal with the branch canal and the power house can be located in the link channel. The typical layout is shown in Fig.21 (d).

In order to align the bypass channel and to locate the power house on the bypass, following information and investigations are generally required:

- Topography of the area by the side of the canal in the vicinity of the fall or falls which are to be used for power generation.
- The availability of land. It is expeditious and economical to locate the bypass channel and power house in the available land owned by canal authorities. If private land is to be acquired, it should be the minimum possible.
- Access to the site
- Assessment of incoming trash
- Power availability for construction
- power evacuation arrangement

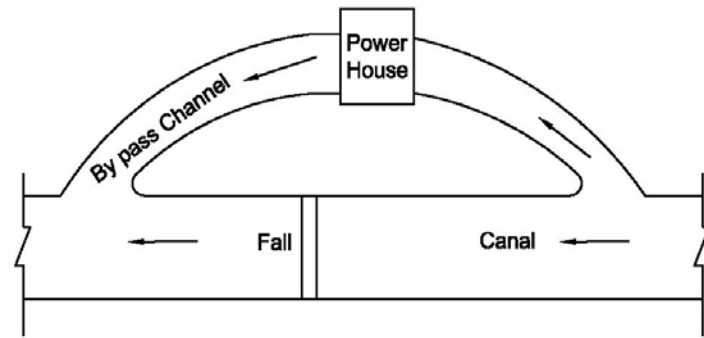

(a)

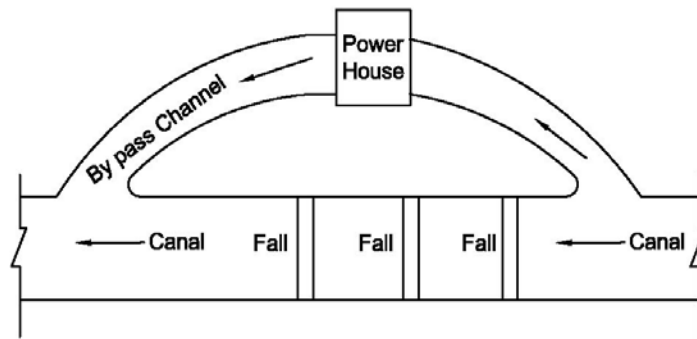

(b)

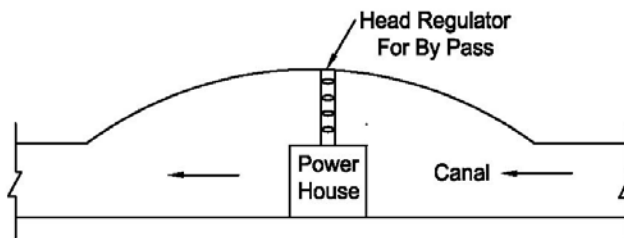

(c)

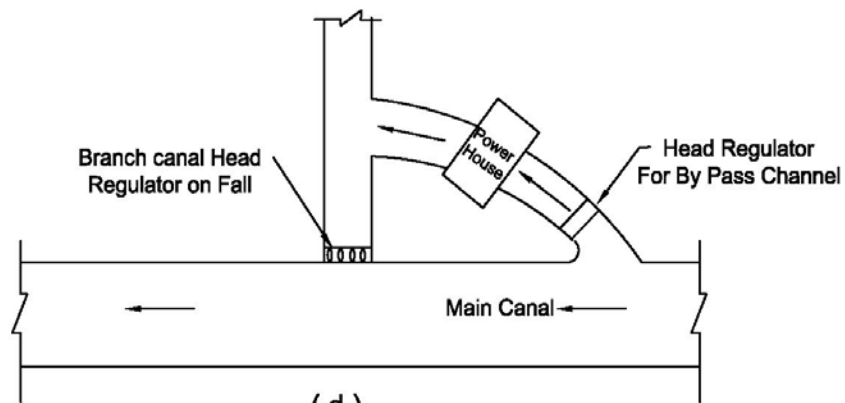

(d)

Fig. 21: Typical Alternate Layouts of Canal fall based Power Houses

8.3 Intake Structures

In case of canal power stations the intake structure fitted with trash rack and regulator gates is made part of the power house building. These typical layouts are shown as Fig 22 and 23.

8.4 Water Conductor

In case of canal power stations water from intake is taken directly to the scroll case of turbine and no separate water conductor is required. It is illustrated in Fig 22 and 23.

8.5 Power House

Generally power house on canal falls are surface power house with horizontal/vertical/ straight setting units. The location of power house should be selected such that required area is available and is sufficiently away from the existing canal to reduce the extent of dewatering during excavation of foundation. The problems which are generally encountered in constructing such power house are

- Seepage control during excavation of power house pit due to the proximity of a canal in operation
- low bearing capacity of the soil strata
- low frictional resistance between power house foundation and the soil resulting in low factor of safety against sliding
- large uplift pressure

In view of above, proper investigations and provision of adequate measures while designing the power house are essential. Generally a raft foundation with adequate base area considering the permissible bearing capacity is provided. In case of low bearing capacity measures may be taken to improve it. If it is not feasible then provision of well foundation or pile foundation should be considered to support the power house raft. Similarly measures should be taken to improve the frictional resistance if the foundation strata are made of clayey soil. These may be consist of (i) increasing the weight of structure by projecting the raft in upstream and loading it, (ii) reducing the uplift, (iii) by replacing the top clayey soil by well graded sand-shingle mix of river bed material (RBM) and (iv) by providing the shear keys (concrete cut-off at upstream and downstream end of the raft.

8.6 Safety Assessment of Existing Structures

Safety of the existing structures such as canal fall or the regulator cum fall is essential and should be adhered without any compromise. If it is an existing old fall on the old canal, it is generally abandoned as well as blocked and a new bypass channel is constructed on either side depending on land availability and the power house is made on this channel. An escape channel on one side of the power house is also made to pass the canal discharge in case the power house shut down or load variation. In this case the safety assessment of canal fall is not warranted. In case of a regulator canal fall on the existing canal, it may be used as a bypass regulator. In that case, the foundation condition and structural soundness of civil works and the condition and operation ability of gates with the load variation on machinery should be ensured. Generally, manually or mechanically operated gates of the regulator do

not meet the operational requirement of the machines unless these are modernized by automation.

8.7 Interfaces with the Irrigation Requirement

The power generation from irrigation/drinking water supply canal based power stations are subject to the running of canals as per irrigation/water supply requirements. Since a bypass is provided, irrigation requirements can easily be passed downstream, in case the power house is either not in operation or is running at part load. Hence with such power houses on canals, there is no interference with irrigation/drinking water supply requirements.

In many canal fall schemes there are issues of silt deposit upstream of canal falls due to maintaining the full supply level in the canal even for low discharge which results in higher head. Such heading up also cause the excessive withdrawal of water through upstream outlets/ distributing and these shall be objectionable from canal owners. These issues may be analysed and suitable measures of regulating water and dealing deposit use of silt be undertaken.

9.0 DAM/ BARRAGE/ WEIR BASED SCHEMES

Dam based schemes are those in which water is stored in the river by constructing a dam across the river for the desired use like irrigation, drinking, flood control. Power is generated at the time of release of water from the dam for the desired use of water. Dam toe power houses can be easily planned at existing dams where power generation was not planned earlier. In dam toe scheme, the intake system forms the part of the main dam. Water is conveyed to the turbine through penstocks installed directly through the outlet barrels / sluices of the dam. For planning a SHP project on existing structure, an assessment of availability of discharge and head from the available records / documents / drawings / data / information has to be made. The information regarding consumptive water use with respect to time will have to be collected for past several years and examined with the river water availability based on long term river flow data (expected to be available at the existing project site), in order to assess the unutilized flows which may be utilized for the power generation through proposed hydro power project.

Alternative studies need to be carried out to provide additional storage of monsoon flows in the existing dam or weir by raising its height for providing water to the proposed SHP project. Possibility of using spilled water for power generation or providing some additional pondage in the barrage/dam may also be examined by raising the gate height or replacing the old gates by the new gates of extra height or installing new gates. In such case, the civil structures of dam/barrage i.e. floor, pier etc. may also have to be strengthened or modified for the new upstream water level.

The head for power generation will depend on the type of structure and location of power house. In case of dam, the head available for power generation will be the difference in water level in existing reservoir and in the river downstream of dam when the power house is at the toe of dam. The variation in levels with time shall be taken into account while carrying out power studies. A weighted average head is worked out to find out the rated head for turbine keeping the maximum and minimum working range of operation. In case the power house is located away from the dam the river slope from the dam to the power house site will be the additional head to be added to the head available due to the height of dam.

Similarly, in case of a barrage the difference in pond level and the water level in the stream in the downstream will determine the head for power generation. During floods the water level difference will be minimum and may be negligible when all barrage gates are opened to pass floods. During high floods, power generation may not be possible. In case power house is located away from the barrage, additional head equal to the drop in river bed from barrage to power house site will be available.

After determining discharge and head, power studies are carried out for planning a new scheme to fix the installed capacity and work out the annual generation.

A dam toe project would normally comprise;

- Intake
- Short penstock including bypass
- Powerhouse building
- Tailrace canal returning flow to main river
- Power evacuation

The intake and penstock would normally be constructed within or in parallel to the outlet works to ensure that water releases would not be interrupted during periods when the plant might be out of service. For pick up type of dams, without any outlet, a syphon over the dam profile or side channel type of intake may be installed. These arrangements require a detailed study and if deployed are good examples of utilizing the hydro potential. The power plant intake and penstock may be incorporated into the diversion works or spillway, if practical, or constructed as a separate facility in an abutment. Typically, dam toe projects are constructed downstream of storage reservoirs that would effectively trap sediment within the reservoir. Therefore, sediment abrasion of turbine components would be a lesser problem with this type of development and would not need a separate desilting arrangement. These plants are often subject to large variation in head and flow and turbine selection must take this into account. Depending on the operating rules of the reservoir, dam toe power plants may generate significant amount of firm energy, or only secondary energy.

9.1 Layout of Dam Toe Schemes

Similar to canal fall schemes, practical consideration of site characteristics, foundations and access to site will probably determine the optimal arrangement. Occasionally original designs of dams will include provision of penstock for planning of a power plant.

In case of a dam, if topography and geology permit, the power house can be located at the toe of the dam. If the existing outlet can be used to feed the power house, its location would be dependent on the location of outlet. The distance between the dam and the power house should be adequate not to affect the dam and its foundation during the construction of power house.

If a new intake / outlet for the proposed power house is required, it is difficult to provide it in the existing concrete or masonry dam. Possibility of installing siphon intake based penstock may be examined or an intake away from dam should be planned and a head race tunnel / penstock / channel be laid through one of the abutments to feed the power house. A typical layout is shown in Fig. 24.

In case of a composite dam (a central spillway of concrete or masonry with earthen flanks on the two sides), a new intake can be considered through one of the earthen flanks in a reach where the height of earthen section is moderate (about 6 to 8 m). Typical three layouts of dam toe SHP schemes are shown in Fig. 24.

In case of a barrage, the power house may be located downstream or away from the barrage. In either case, the intake for power house would generally be required to be located by the side of the barrage. However, possibility of using the existing intake for canal or tunnel be explored. In case of a power house just downstream of barrage, extra or additional discharge for power house may be drawn through existing canal head and may be diverted to the power house by constructing a canal head in the bank of existing canal. Another possibility of using a bay of the barrage to release required discharge for the power house can also be explored. The power house in this case may be located in the river bed and has to be protected from floods.

9.2 Intake Structure

In dam based scheme, priority should be to use the existing intake structure and the outlet or one of the outlets for the proposed power generation scheme. In case the above is not feasible or there is no outlet in the dam/diversion structure, a new intake structure will have to be located. It is not feasible to provide a new intake in a concrete / masonry dam as part of the dam. In such a case an intake away from the dam will have to be located along with a water conductor through the abutment to feed the power house either at the toe of the dam or away from the dam.

In case of earthen embankments of small to medium heights an intake can be constructed by cutting the embankment, to embed the conduit/barrel/pipe. A typical arrangement is shown in Fig. 25.

In case of barrage, various alternatives mentioned below should be explored.

- (i) Use of existing canal intake, if it has additional discharge capacity
- (ii) A new intake with a conduit / canal through abutment in case barrage is not being used to divert flows or diversion is through one bank only.
- (iii) Use of one of the barrage bays as intake for the power house located downstream of the barrage.

9.3 Water Conductor System

Water conductor may be a conduit/pipe/tunnel running under pressure or as free flow. It may be also an open channel. The type of water conductor will depend on the type of intake, location of power house and the topography. If the power house is at the toe of dam the water conductor will be a conduit/pipe running under pressure. In case of power house downstream of a barrage the water conductor may be an open channel. If the power house is away from the dam or barrage the water conductor can be a tunnel running under pressure or free flow or an open channel. The selection between a tunnel and an open channel will depend on the topography and the geology. It can also be a combination of tunnel and open channel in part reaches as per topographical conditions.

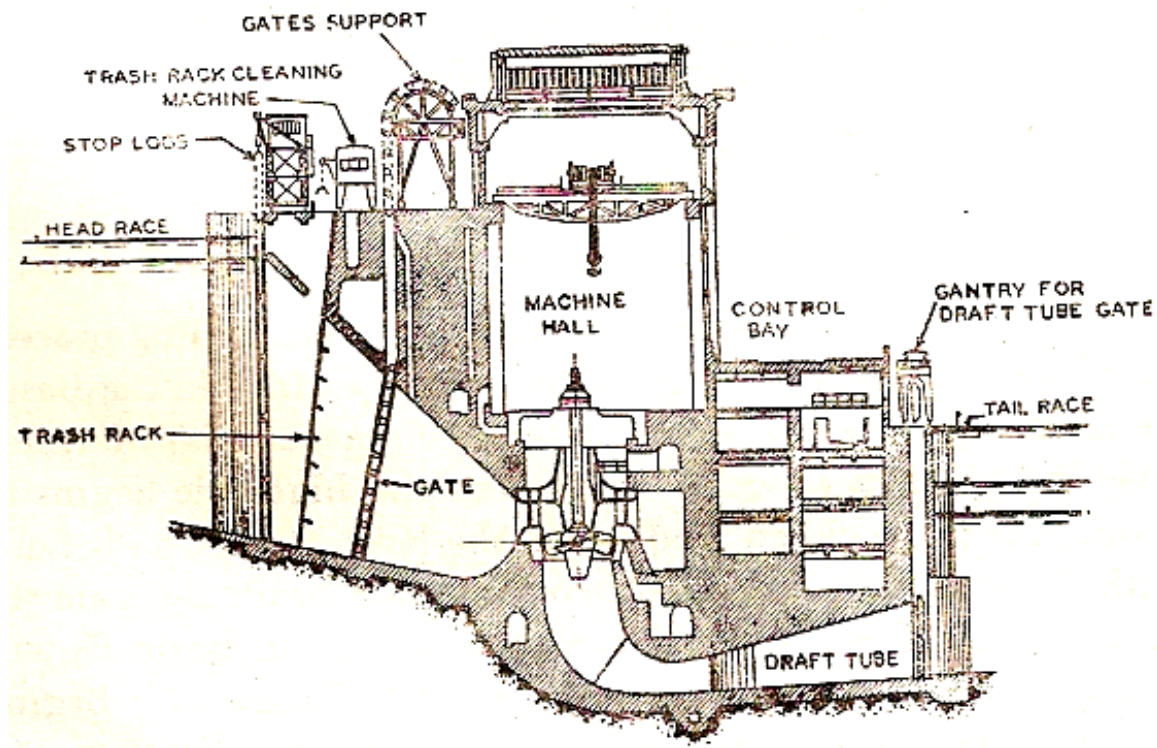

Fig. 22: Typical Canal Intake with Power House Building
 (Adopted from E Mosonyi: Water Power Development – Low Head Power Plants)

9.4 Power House Location

The power house can be located either at the toe of the dam / barrage or away from the dam. It depends on the topography, geology and the economy. Generally SHP are surface power stations. The location of the power house should be selected such that the required area is available without much excavation and slope destabilization. In rocky strata, bearing capacity will generally not be a problem but in case of siting a power house on river bed deposits the aspect of bearing capacity and ground water conditions should be carefully investigated from both design and construction considerations.

The foundation conditions, the structural stability and soundness of existing structure are the factors for deciding the location of the power house. Depending on the chosen location of power house the extension of the existing outlet in the dam will have to be decided. Penstock may be single, bifurcated or trifurcated depending on the number of units. But in the most of cases, the penstock being of short length, are provided independently to each unit.

Typical layouts are shown for choosing a new alignment of existing dam toe schemes in Fig. 26.

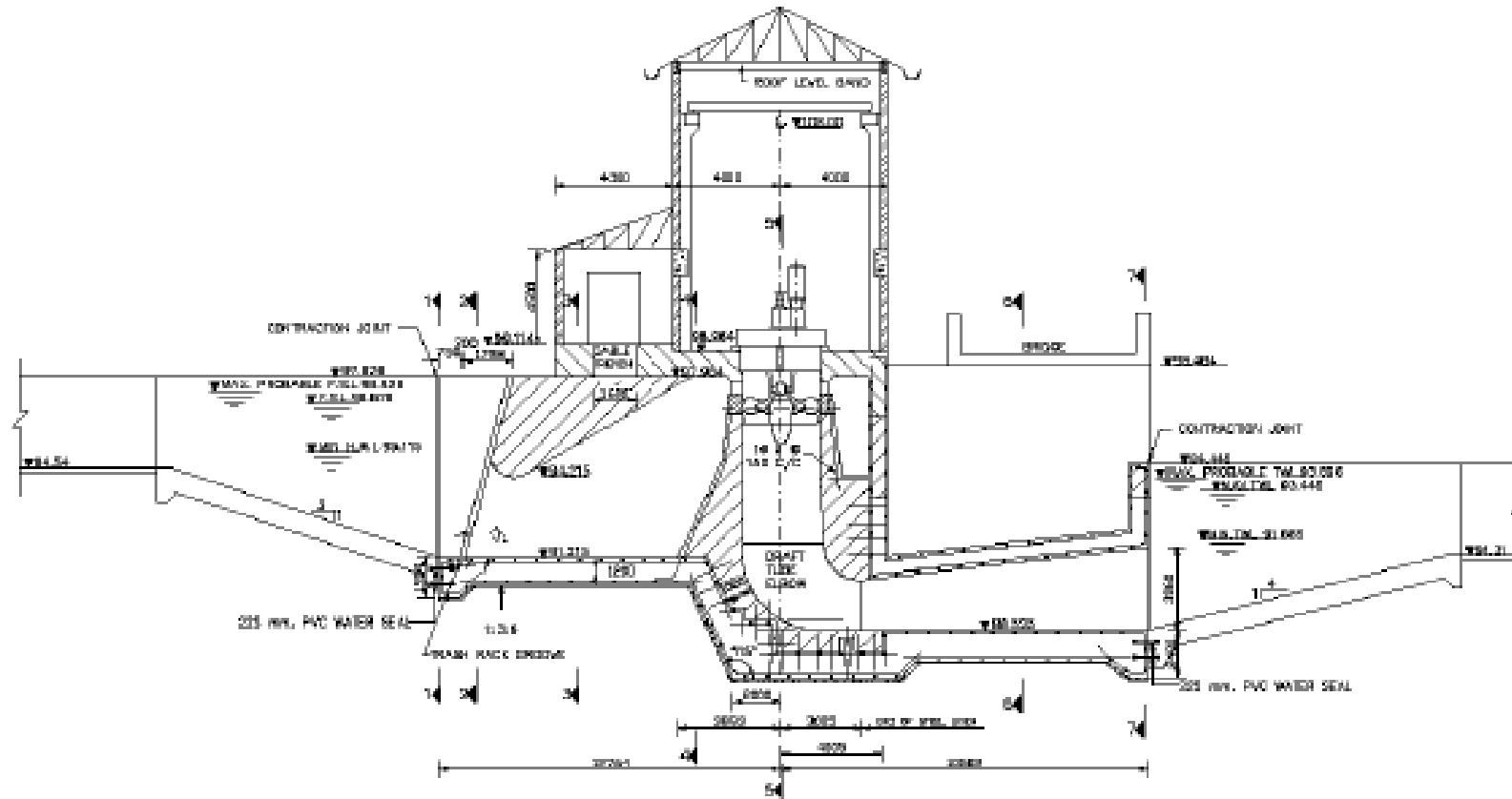

Fig. 23: Typical Intake on Canal Fall with Siphon intake based turbine

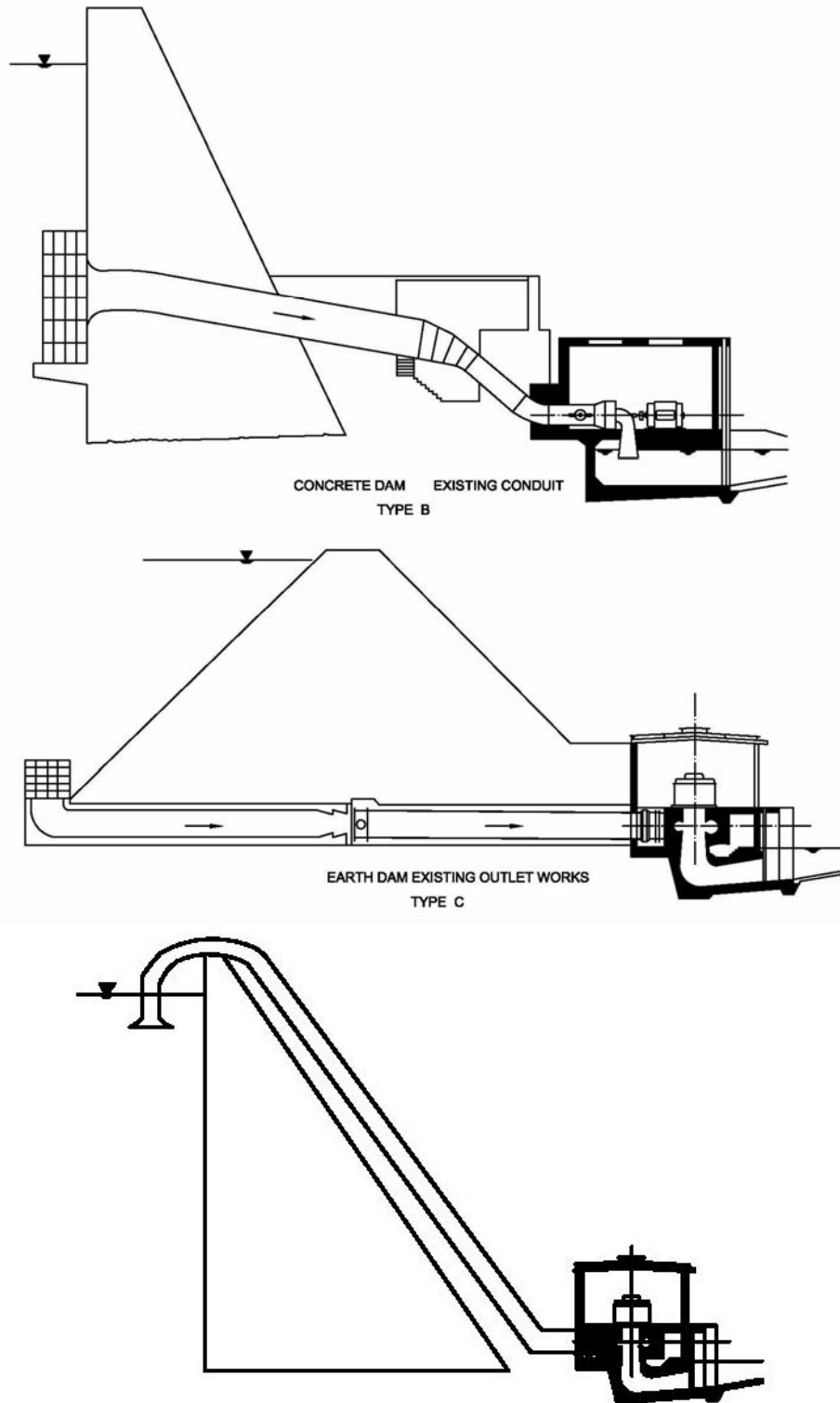

Fig. 24: Typical Layouts of Dam Toe Scheme
 (Adopted from Tudor Engineering Company for USBR, Reconnaissance Evaluation of Small, Low – Head Hydroelectric Installations)

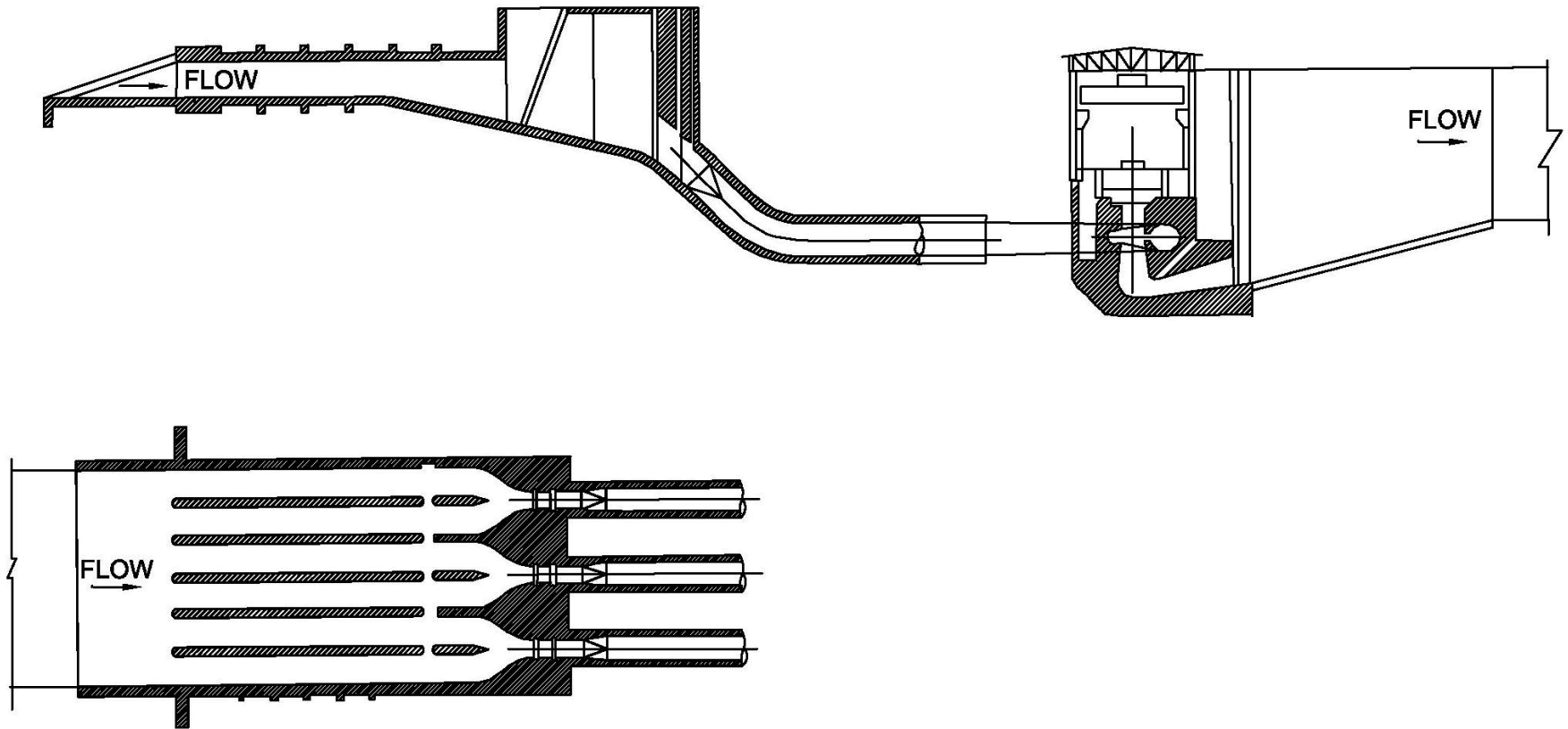

Fig. 25: Typical Layout of SHP Using Abutment of an Existing Dam

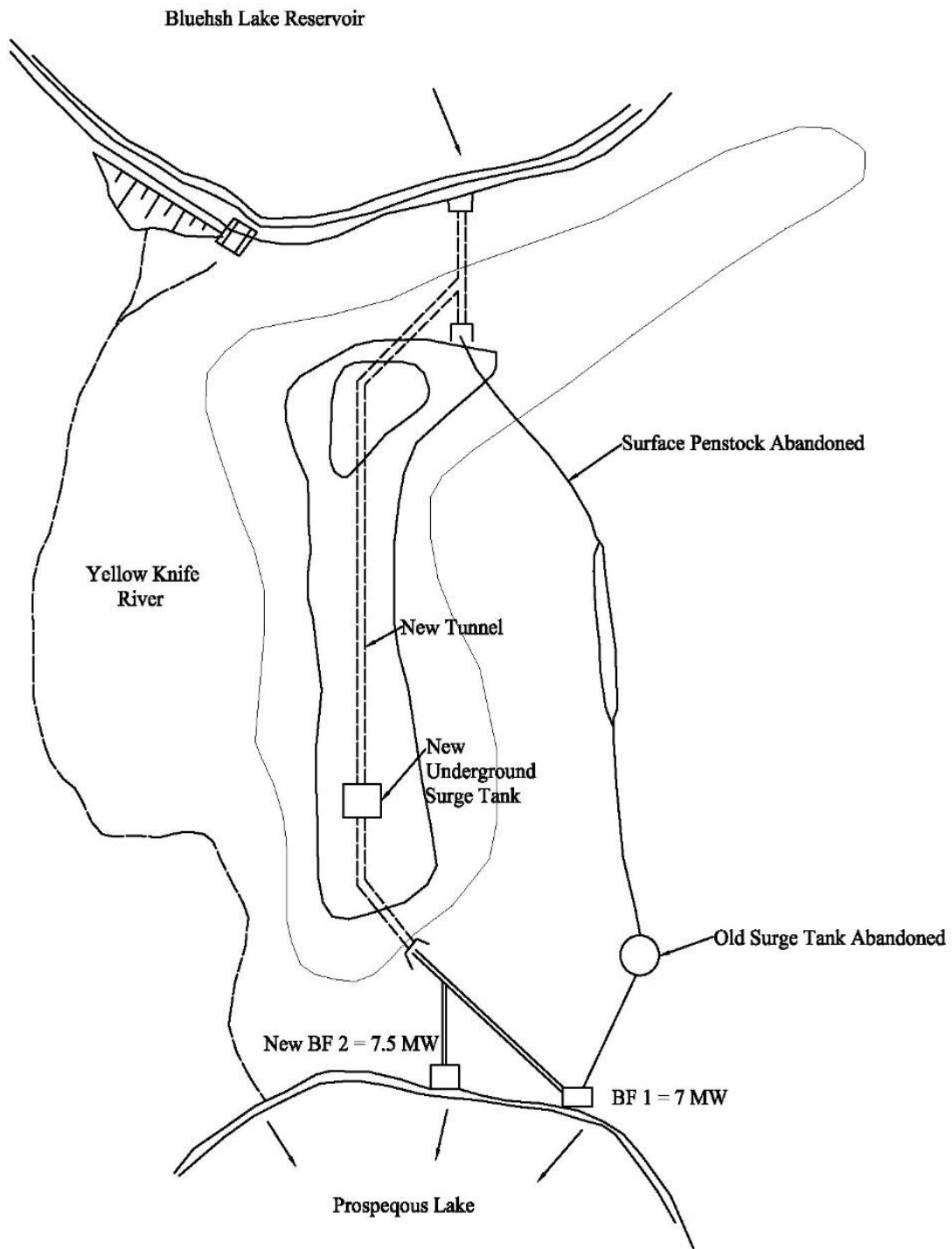

Fig. 26: Arrangement for New SHP (abandoning old powerhouse) on a Reservoir

9.5 Raising Full Reservoir Level

If hydrological assessment shows availability of additional water and the dam height can be raised to store extra water without affecting the stability of the existing structure and the foundation, the raising of full reservoir level should be explored for harnessing possible hydropower. This has an advantage of providing additional head as well as discharge for power generation. The radial type of gates or inflated rubber gates can be deployed to raise the water levels in the dams.

9.6 Interfacing with Irrigation Requirements

In case, a dam toe power house is located in an existing irrigation dam/barrage, the irrigation releases can be used for power generation. In such situations irrigation is first priority and so power generation will be subject to temporal irrigation requirement. In case, water is spilled during rainy season, the same may be utilized for power generation. However, if water is not required for irrigation use, an escape structure downstream of power house may be constructed.

There can be a situation, where a dam is constructed and the irrigation canal takes off from a pick-up weir located some distance downstream of the dam from topographical considerations. In that case, the power house can be located at the toe of the dam or at any other suitable location upstream of the pickup weir utilizing total irrigation releases for power generation subject to temporal irrigation requirements

In case a power station utilizes the head available at a barrage due to the difference in pond level and water level in the river in the downstream, canal flows and its operation will generally be independent of the flows to be utilized for power generation.

9.7 Safety Assessment of Existing Structures and Further Investigations

The assessment of the safety of existing structures is very important and required investigations should be carried out prior to finalizing the layout of the scheme. The following schedule for safety assessment should be followed:

- (i) Visual inspection of structures to assess physical conditions and to have a feel of the general conditions and aging effect on the structures, an idea of leakage and seepage through structures and gate etc., an idea of the extent to which maintenance is being done and an idea about topography regarding the location of power house and the new intake, if required.
- (ii) Study of records of inspections, repair and maintenance of the structures, gates, hoisting arrangement etc. to have the idea of the damages suffered by the structure and their effect on the life of structures. Generally the life of civil structures like dams, barrage and canal is taken as 100 years and the hydro mechanical and electro-mechanical equipment have a life of around 30 to 35 years.
- (iii) Study of hydrological data to assess the high floods, impact of which the structures have withstood.
- (iv) Study of the geology and geo-technical investigation reports of the site when the existing works were planned and constructed.

- (v) Study of design details both hydraulic and structural including computations, drawings, photographs of construction stage etc. to have the idea of quality of construction, structural strength and operational requirement of the structures and the assumptions made during their design. This will help in deciding about the possibility of raising the height of existing diversion structure.
- (vi) Field and laboratory tests of concrete / masonry and foundation rock samples to assess present strength and deterioration, if any.
- (vii) Investigations to assess the ground water table conditions in the vicinity of structures in order to have the idea of the difficulties to be encountered during construction of proposed works near the existing structures.
- (viii) To carry out topographical and geotechnical investigations for the proposed structures such as intake, water conductor and power house sites. Existing structures shall be included in these investigations if the old data / record is not available.
- (ix) Reservoir / pond survey to assess the present storage capacity and encroachments, if such data is not available.
- (x) A survey of existing infrastructural facilities should be carried out.
- (xi) Survey for availability of construction material should be carried out and samples should be tested in laboratory for their suitability in concrete.
- (xii) Power evacuation study should be carried out.
- (xiii) Study for assessing the environmental impact of proposed power house should be carried out.

Safety assessment report should be prepared including management plan for carrying out required safety measures.
