

Fluid Mechanics: Fundamentals and Applications, 2nd Edition
Yunus A. Cengel, John M. Cimbala
McGraw-Hill, 2010

Chapter 1

INTRODUCTION AND BASIC CONCEPTS

Lecture slides by
Hasan Hacışevki

Copyright © The McGraw-Hill Companies, Inc. Permission required for reproduction or display.

Schlieren image showing the thermal plume produced by Professor Cimbala as he welcomes you to the fascinating world of fluid mechanics.

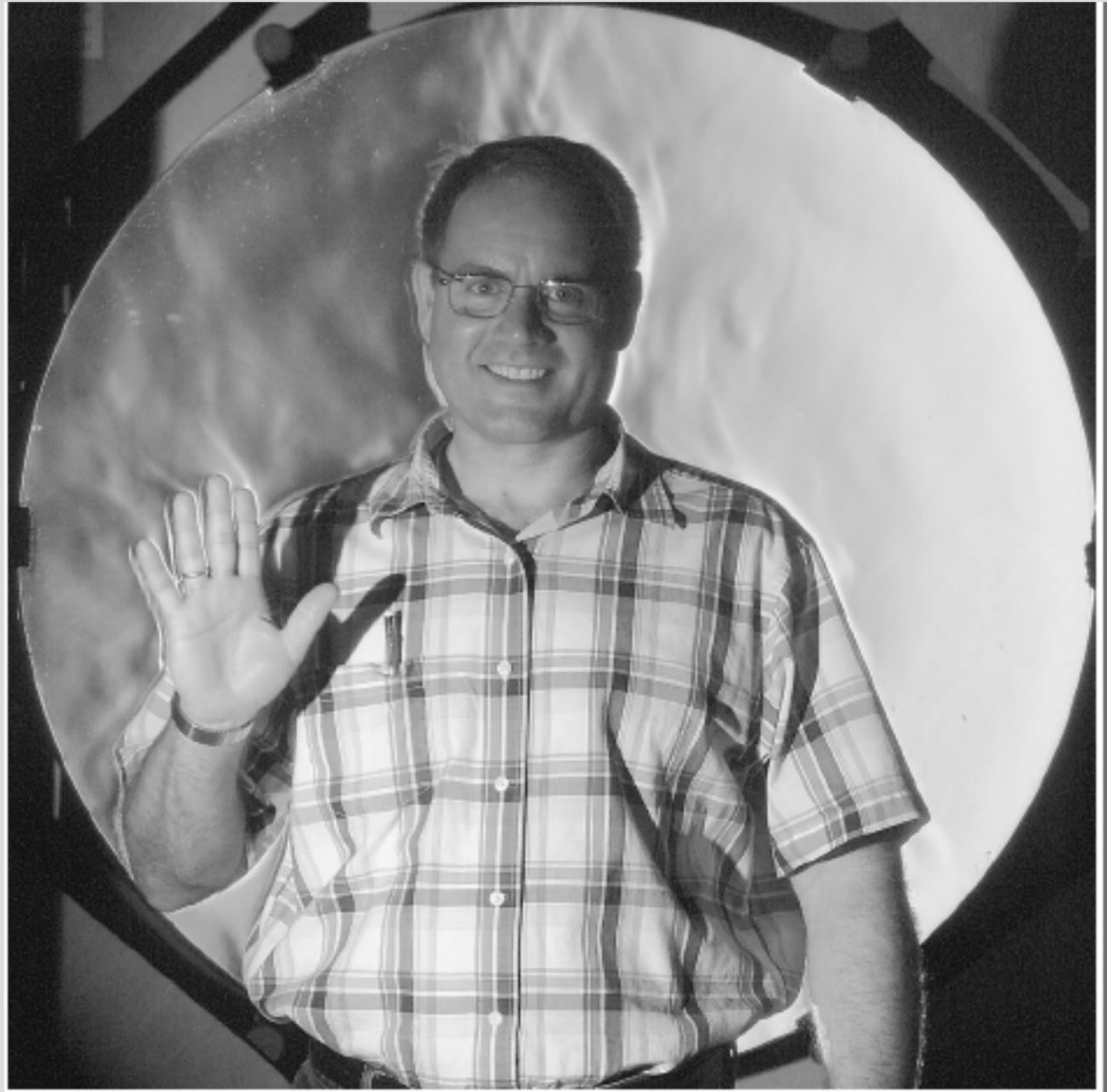

Objectives

- Understand the basic concepts of Fluid Mechanics.
- Recognize the various types of fluid flow problems encountered in practice.
- Model engineering problems and solve them in a systematic manner.
- Have a working knowledge of accuracy, precision, and significant digits, and recognize the importance of dimensional homogeneity in engineering calculations.

1-1 ■ INTRODUCTION

Mechanics: The oldest physical science that deals with both stationary and moving bodies under the influence of forces.

Statics: The branch of mechanics that deals with bodies at rest.

Dynamics: The branch that deals with bodies in motion.

Fluid mechanics: The science that deals with the behavior of fluids at rest (*fluid statics*) or in motion (*fluid dynamics*), and the interaction of fluids with solids or other fluids at the boundaries.

Fluid dynamics: Fluid mechanics is also referred to as fluid dynamics by considering fluids at rest as a special case of motion with zero velocity.

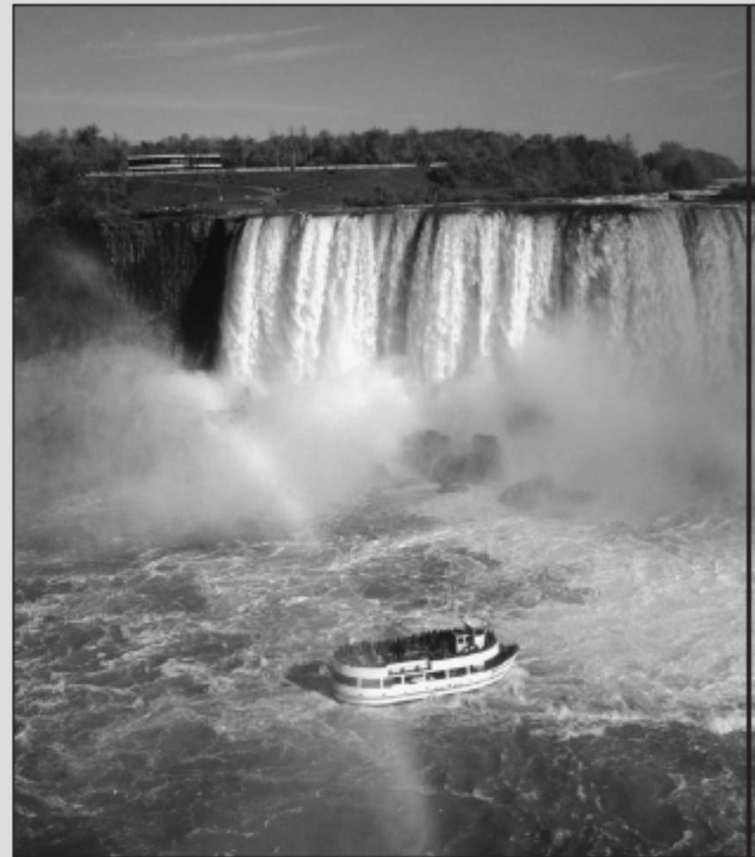

Fluid mechanics deals with liquids and gases in motion or at rest.⁴

Hydrodynamics: The study of the motion of fluids that can be approximated as incompressible (such as liquids, especially water, and gases at low speeds).

Hydraulics: A subcategory of hydrodynamics, which deals with liquid flows in pipes and open channels.

Gas dynamics: Deals with the flow of fluids that undergo significant density changes, such as the flow of gases through nozzles at high speeds.

Aerodynamics: Deals with the flow of gases (especially air) over bodies such as aircraft, rockets, and automobiles at high or low speeds.

Meteorology, oceanography, and hydrology: Deal with naturally occurring flows.

What Is a Fluid?

Fluid: A substance in the liquid or gas phase.

A solid can resist an applied shear stress by deforming.

A fluid deforms continuously under the influence of a shear stress, no matter how small.

In solids, stress is proportional to *strain*, but in fluids, stress is proportional to *strain rate*.

When a constant shear force is applied, a solid eventually stops deforming at some fixed strain angle, whereas a fluid never stops deforming and approaches a constant *rate* of strain.

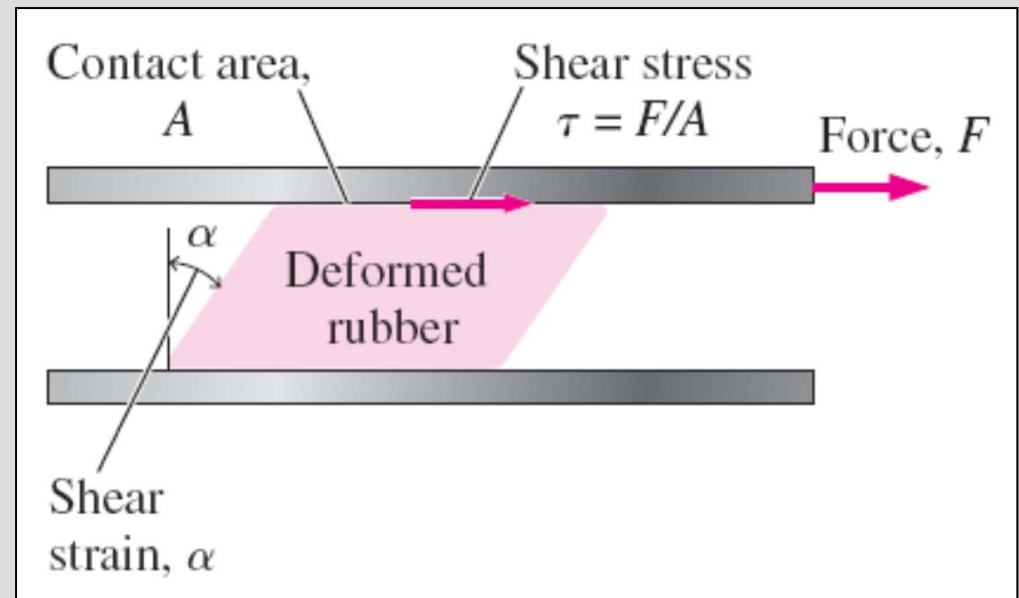

Deformation of a rubber block placed between two parallel plates under the influence of a shear force. The shear stress shown is that on the rubber—an equal but opposite shear stress acts on the upper plate.

Stress: Force per unit area.

Normal stress: The normal component of a force acting on a surface per unit area.

Shear stress: The tangential component of a force acting on a surface per unit area.

Pressure: The normal stress in a fluid at rest.

Zero shear stress: A fluid at rest is at a state of zero shear stress.

When the walls are removed or a liquid container is tilted, a shear develops as the liquid moves to re-establish a horizontal free surface.

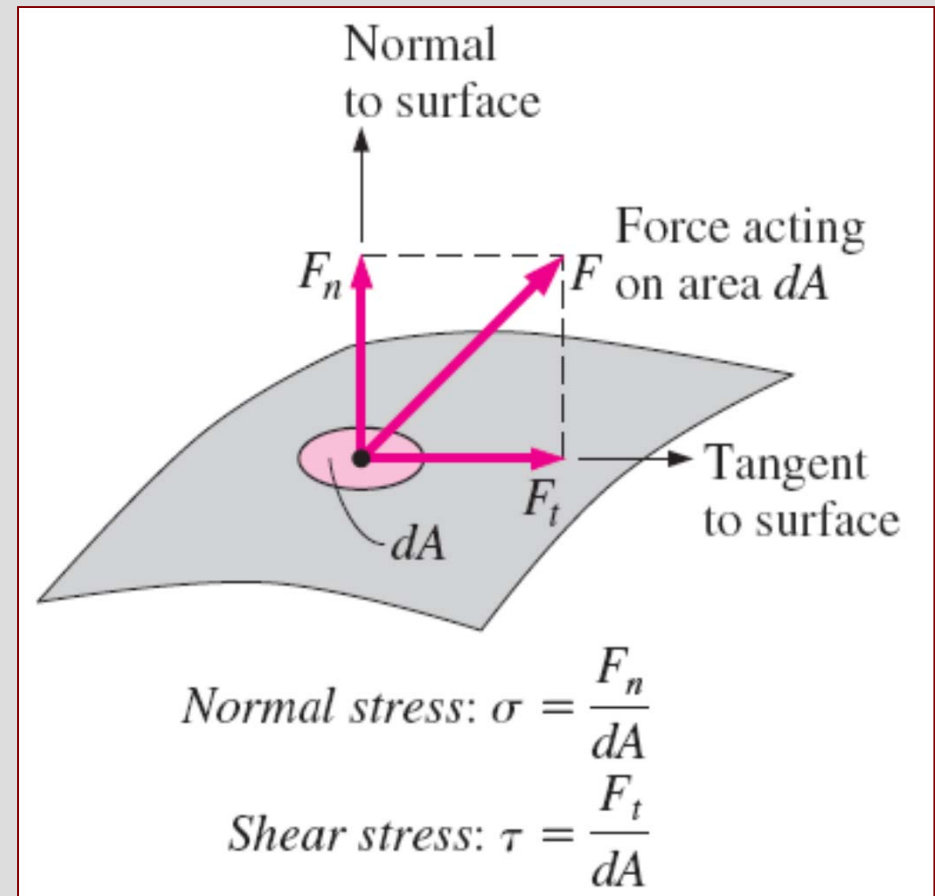

The normal stress and shear stress at the surface of a fluid element. For fluids at rest, the shear stress is zero and pressure is the only normal stress.

In a **liquid**, groups of molecules can move relative to each other, but the volume remains relatively constant because of the strong cohesive forces between the molecules. As a result, a liquid takes the shape of the container it is in, and it forms a free surface in a larger container in a gravitational field.

A **gas** expands until it encounters the walls of the container and fills the entire available space. This is because the gas molecules are widely spaced, and the cohesive forces between them are very small. Unlike liquids, a gas in an open container cannot form a free surface.

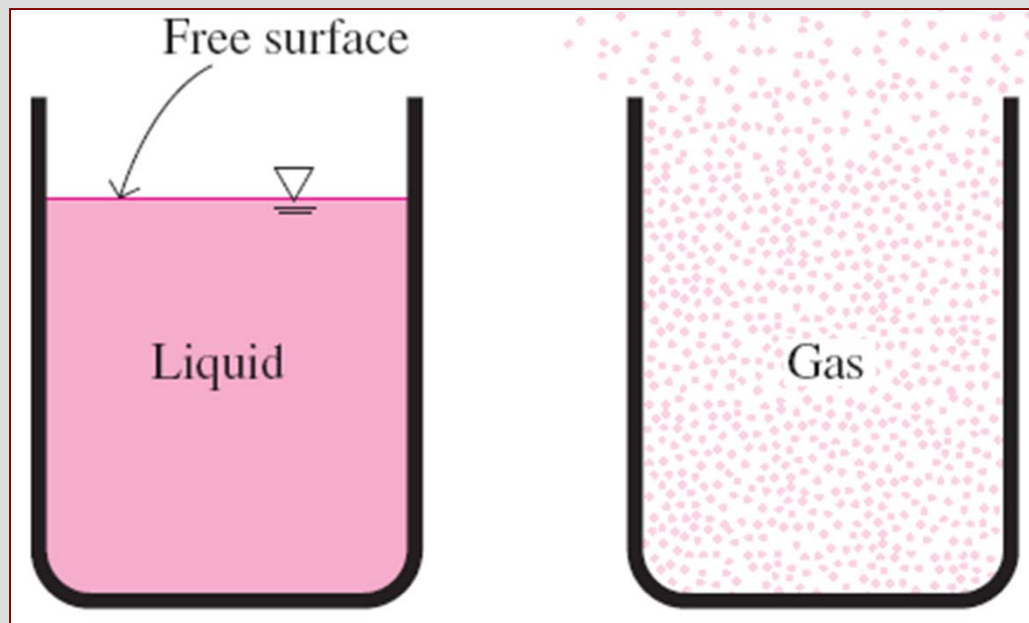

Unlike a liquid, a gas does not form a free surface, and it expands to fill the entire available space.

Intermolecular bonds are strongest in solids and weakest in gases.

Solid: The molecules in a solid are arranged in a pattern that is repeated throughout.

Liquid: In liquids molecules can rotate and translate freely.

Gas: In the gas phase, the molecules are far apart from each other, and molecular ordering is nonexistent.

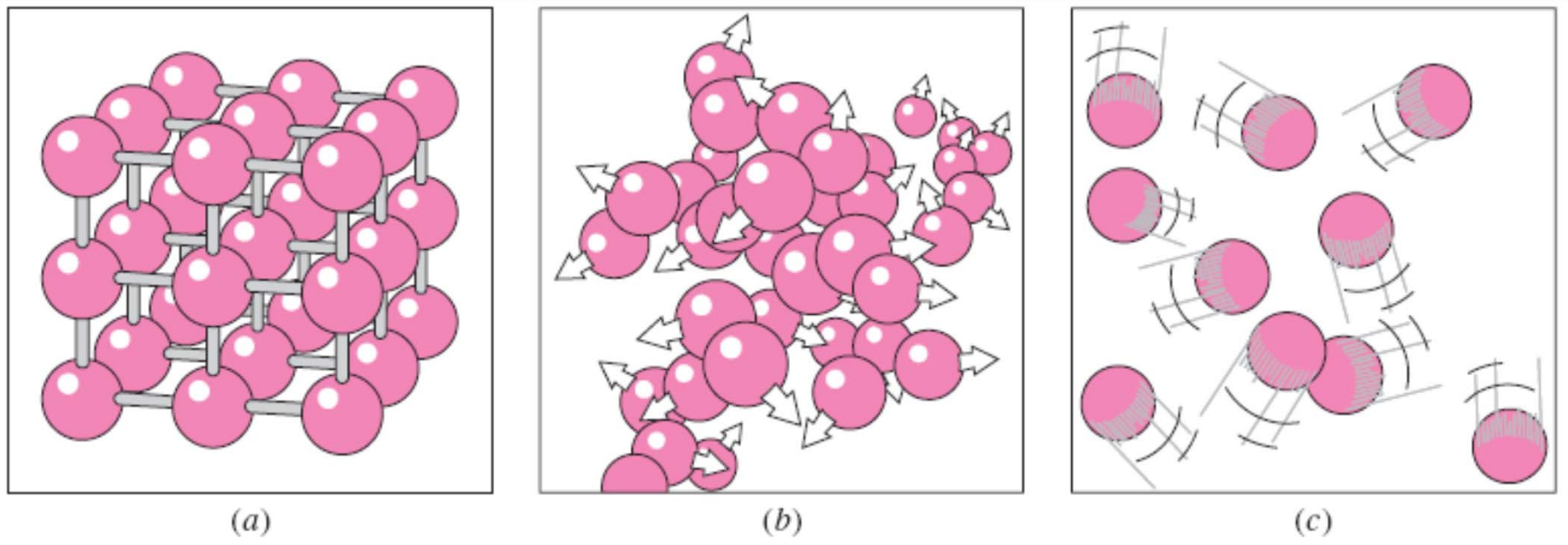

The arrangement of atoms in different phases: (a) molecules are at relatively fixed positions in a solid, (b) groups of molecules move about each other in the liquid phase, and (c) individual molecules move about at random in the gas phase.

Gas and *vapor* are often used as synonymous words.

Gas: The vapor phase of a substance is customarily called a *gas* when it is above the critical temperature.

Vapor: Usually implies that the current phase is not far from a state of condensation.

Macroscopic or *classical* approach:

Does not require a knowledge of the behavior of individual molecules and provides a direct and easy way to analyze engineering problems.

Microscopic or *statistical* approach:

Based on the average behavior of large groups of individual molecules.

On a microscopic scale, pressure is determined by the interaction of individual gas molecules. However, we can measure the pressure on a macroscopic scale with a pressure gage.

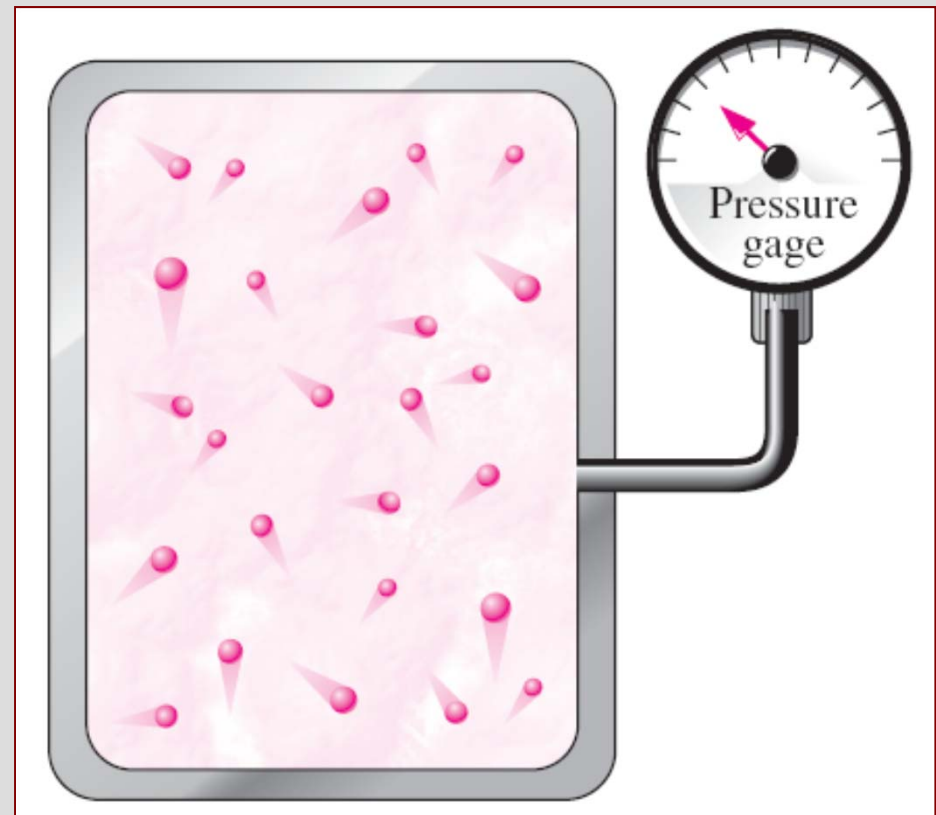

Application Areas of Fluid Mechanics

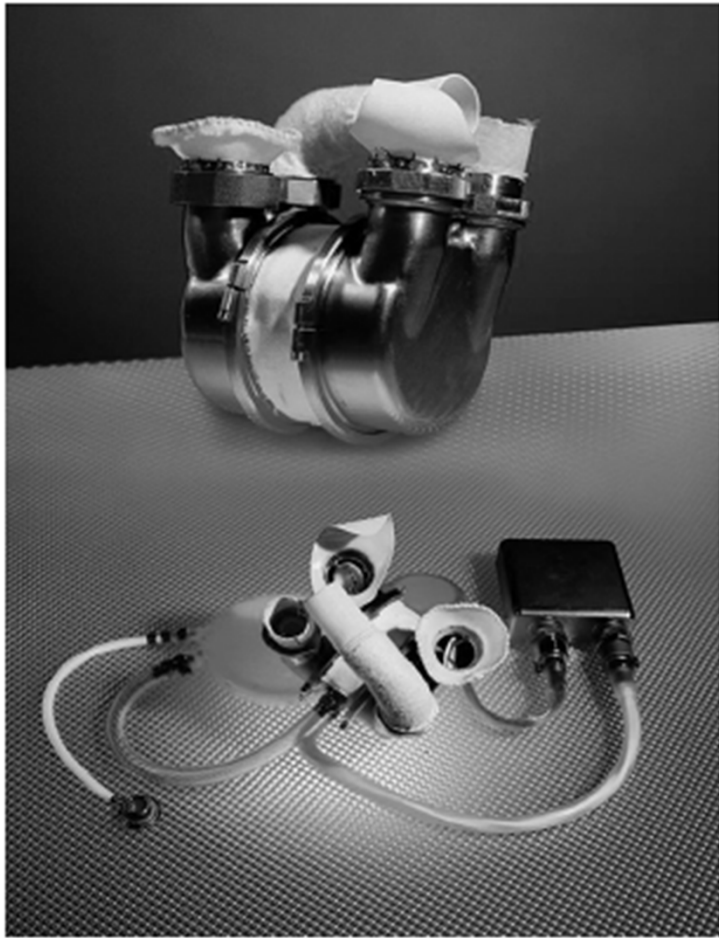

Fluid dynamics is used extensively in the design of artificial hearts. Shown here is the Penn State Electric Total Artificial Heart.



Natural flows and weather

© Vol. 16/Photo Disc.



Power plants



Boats

© Vol. 5/Photo Disc.



Human body



Aircraft and spacecraft

© Vol. 1/Photo Disc.



Cars



Wind turbines



Piping and plumbing systems



Industrial applications

1-2 ■ THE NO-SLIP CONDITION

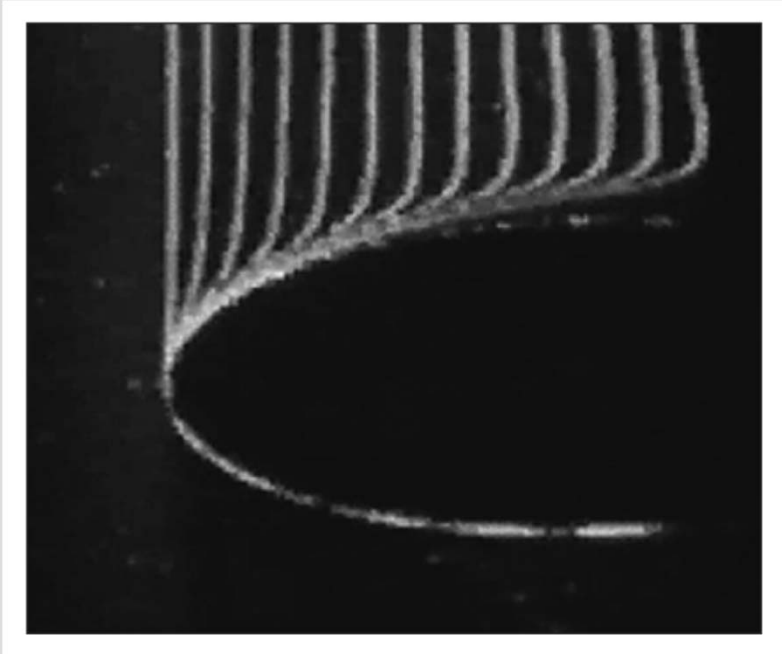

The development of a velocity profile due to the no-slip condition as a fluid flows over a blunt nose.

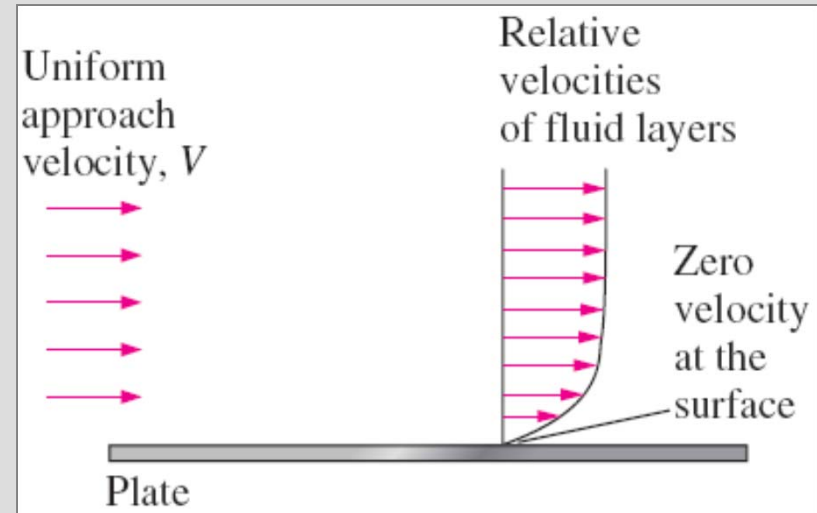

A fluid flowing over a stationary surface comes to a complete stop at the surface because of the no-slip condition.

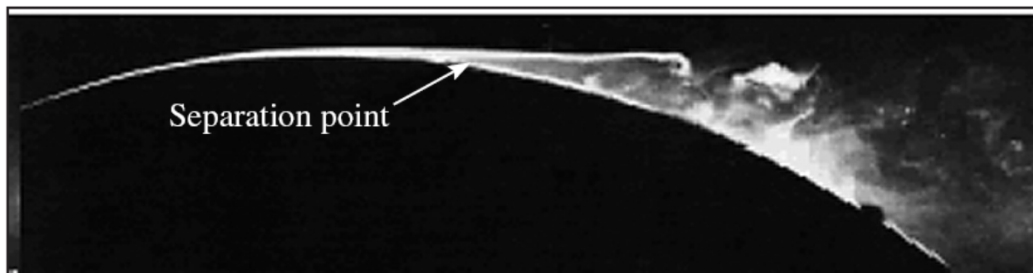

Flow separation during flow over a curved surface.

Boundary layer: The flow region adjacent to the wall in which the viscous effects (and thus the velocity gradients) are significant.

1–3 ■ A BRIEF HISTORY OF FLUID MECHANICS



Segment of Pergamon pipeline. Each clay pipe section was 13 to 18 cm in diameter.

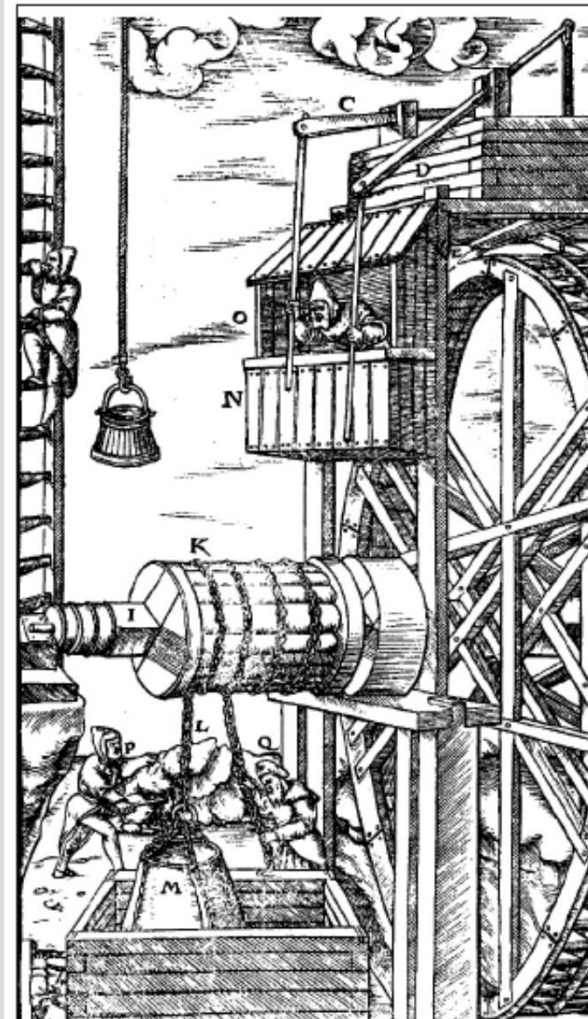

A mine hoist powered by a reversible water wheel.

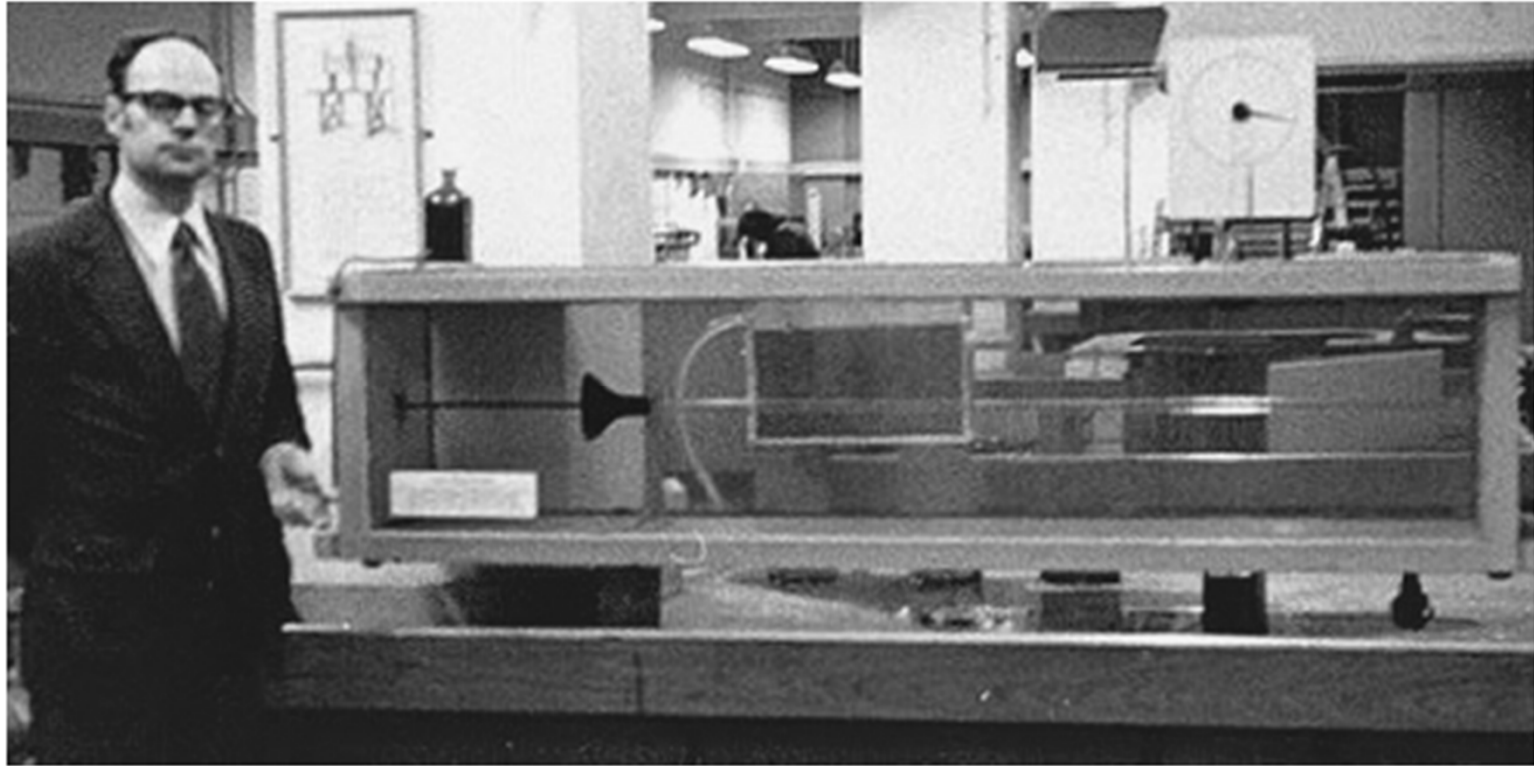

Osborne Reynolds' original apparatus for demonstrating the onset of turbulence in pipes, being operated by John Lienhard at the University of Manchester in 1975.

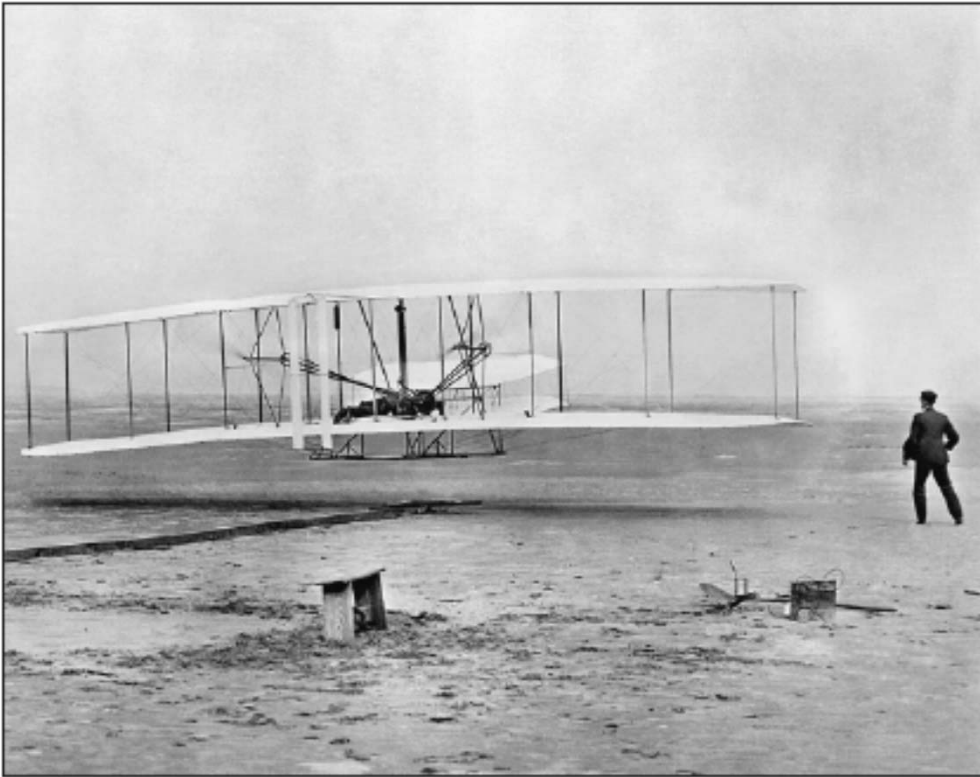

The Wright brothers take flight at Kitty Hawk.

The Oklahoma Wind Power Center near Woodward consists of 68 turbines, 1.5 MW each.



1-4 ■ CLASSIFICATION OF FLUID FLOWS

Viscous versus Inviscid Regions of Flow

Viscous flows: Flows in which the frictional effects are significant.

Inviscid flow regions: In many flows of practical interest, there are *regions* (typically regions not close to solid surfaces) where viscous forces are negligibly small compared to inertial or pressure forces.

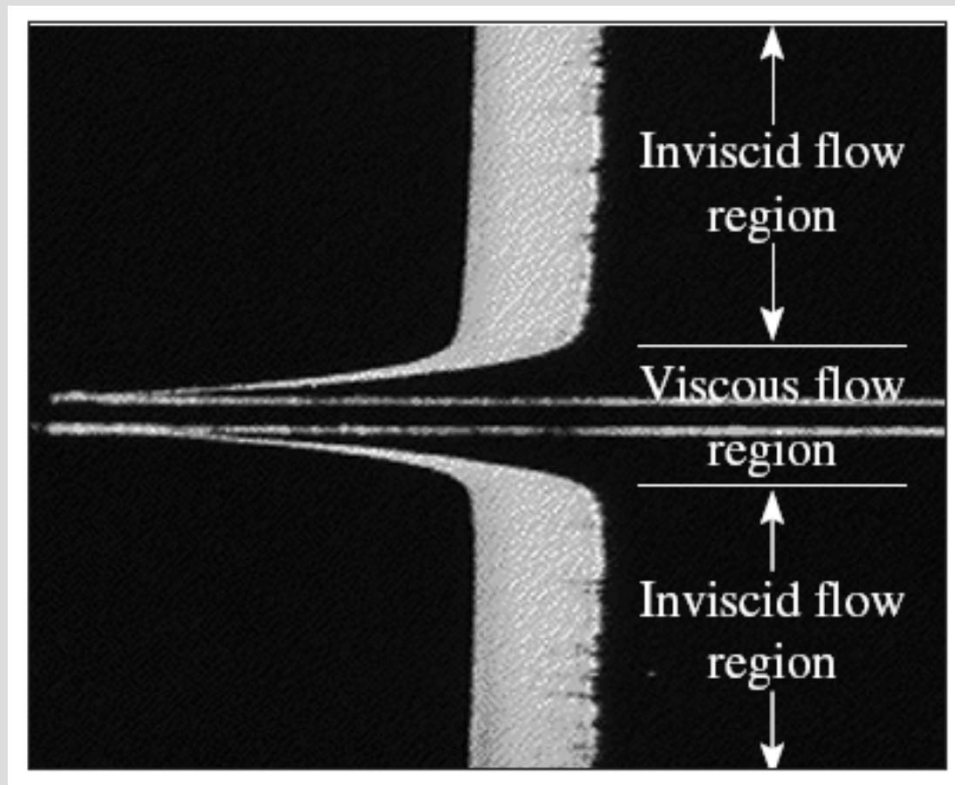

The flow of an originally uniform fluid stream over a flat plate, and the regions of viscous flow (next to the plate on both sides) and inviscid flow (away from the plate).

Internal versus External Flow

External flow: The flow of an unbounded fluid over a surface such as a plate, a wire, or a pipe.

Internal flow: The flow in a pipe or duct if the fluid is completely bounded by solid surfaces.



External flow over a tennis ball, and the turbulent wake region behind.

- Water flow in a pipe is internal flow, and airflow over a ball is external flow .
- The flow of liquids in a duct is called *open-channel flow* if the duct is only partially filled with the liquid and there is a free surface.

Compressible versus Incompressible Flow

Incompressible flow: If the density of flowing fluid remains nearly constant throughout (e.g., liquid flow).

Compressible flow: If the density of fluid changes during flow (e.g., high-speed gas flow)

When analyzing rockets, spacecraft, and other systems that involve high-speed gas flows, the flow speed is often expressed by **Mach number**

$$\text{Ma} = \frac{V}{c} = \frac{\text{Speed of flow}}{\text{Speed of sound}}$$

- Ma = 1** **Sonic flow**
- Ma < 1** **Subsonic flow**
- Ma > 1** **Supersonic flow**
- Ma >> 1** **Hypersonic flow**

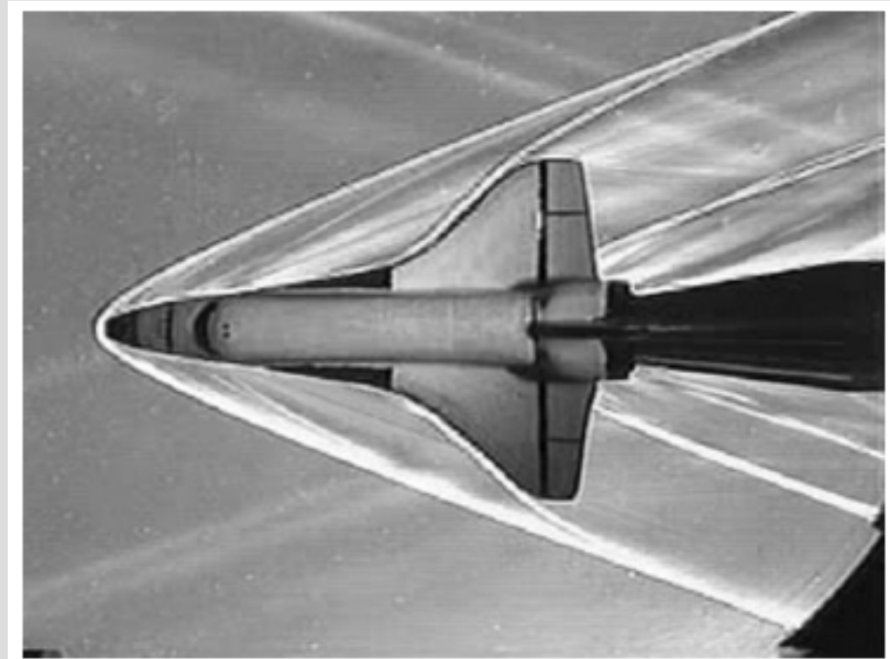

Schlieren image of a small model of the space shuttle orbiter being tested at Mach 3 in the supersonic wind tunnel of the Penn State Gas Dynamics Lab. Several *oblique shocks* are seen in the air surrounding the spacecraft.

Laminar versus Turbulent Flow

Laminar flow: The highly ordered fluid motion characterized by smooth layers of fluid. The flow of high-viscosity fluids such as oils at low velocities is typically laminar.

Turbulent flow: The highly disordered fluid motion that typically occurs at high velocities and is characterized by velocity fluctuations. The flow of low-viscosity fluids such as air at high velocities is typically turbulent.

Transitional flow: A flow that alternates between being laminar and turbulent.

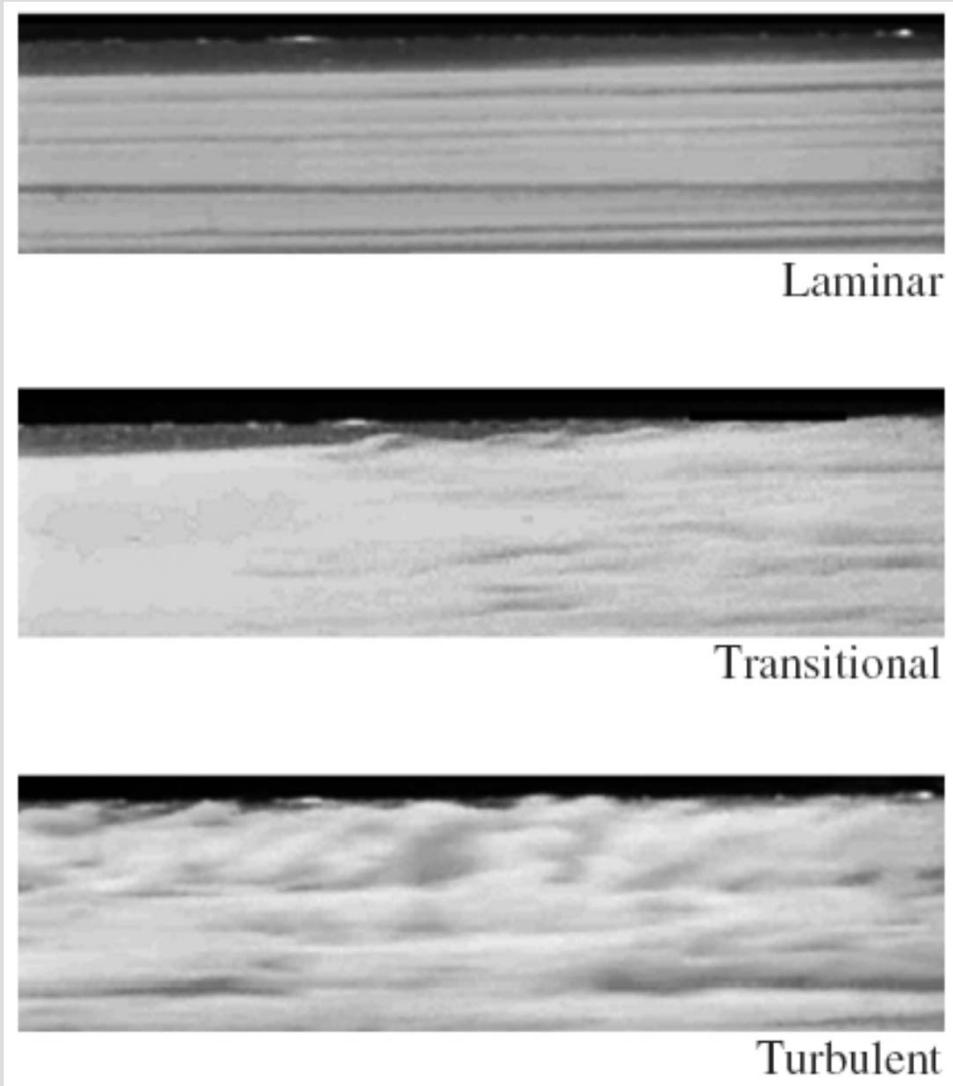

Laminar, transitional, and turbulent flows.

Natural (or Unforced) versus Forced Flow

Forced flow: A fluid is forced to flow over a surface or in a pipe by external means such as a pump or a fan.

Natural flow: Fluid motion is due to natural means such as the buoyancy effect, which manifests itself as the rise of warmer (and thus lighter) fluid and the fall of cooler (and thus denser) fluid.

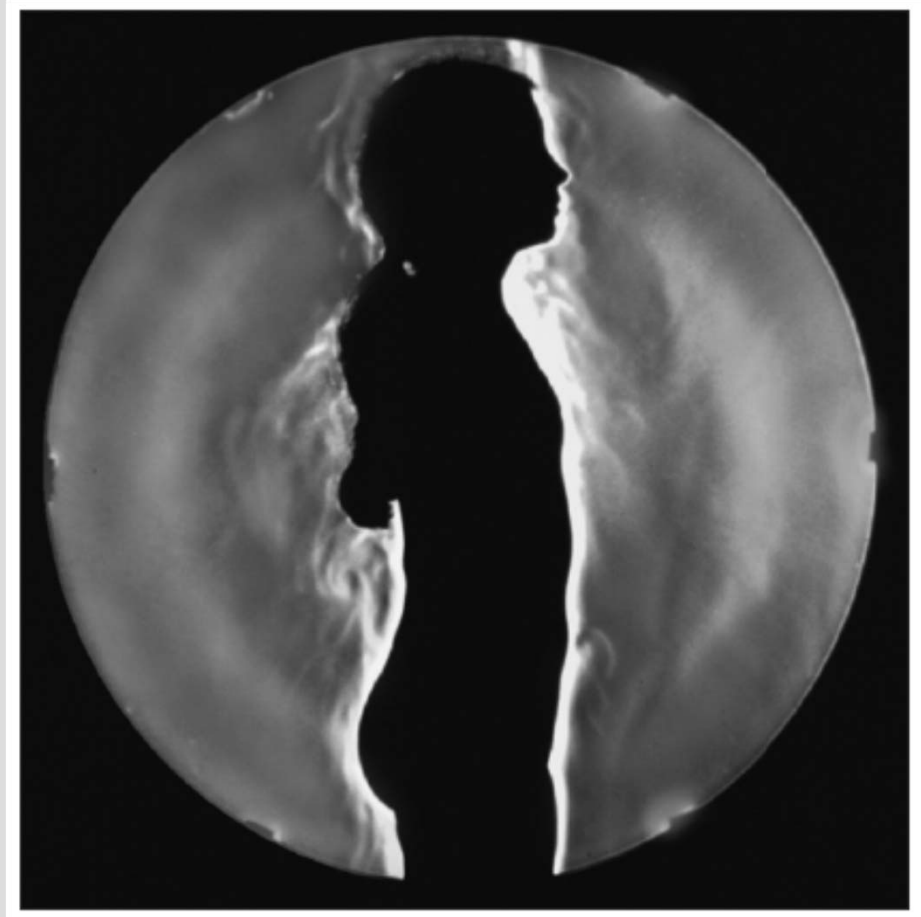

In this schlieren image of a girl in a swimming suit, the rise of lighter, warmer air adjacent to her body indicates that humans and warm-blooded animals are surrounded by thermal plumes of rising warm air.

Steady versus Unsteady Flow

- The term **steady** implies *no change at a point with time*.
- The opposite of steady is **unsteady**.
- The term **uniform** implies *no change with location* over a specified region.
- The term **periodic** refers to the kind of unsteady flow in which the flow oscillates about a steady mean.
- Many devices such as turbines, compressors, boilers, condensers, and heat exchangers operate for long periods of time under the same conditions, and they are classified as **steady-flow devices**.

Oscillating wake of a blunt-based airfoil at Mach number 0.6. Photo (a) is an instantaneous image, while photo (b) is a long-exposure (time-averaged) image.

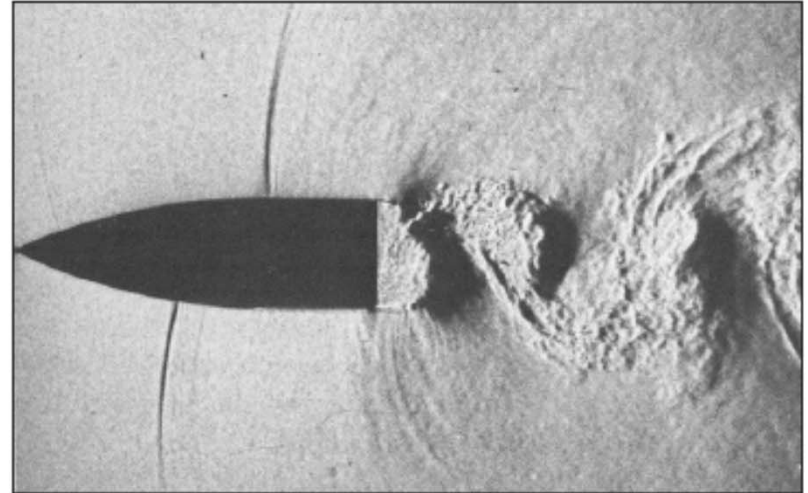

(a)

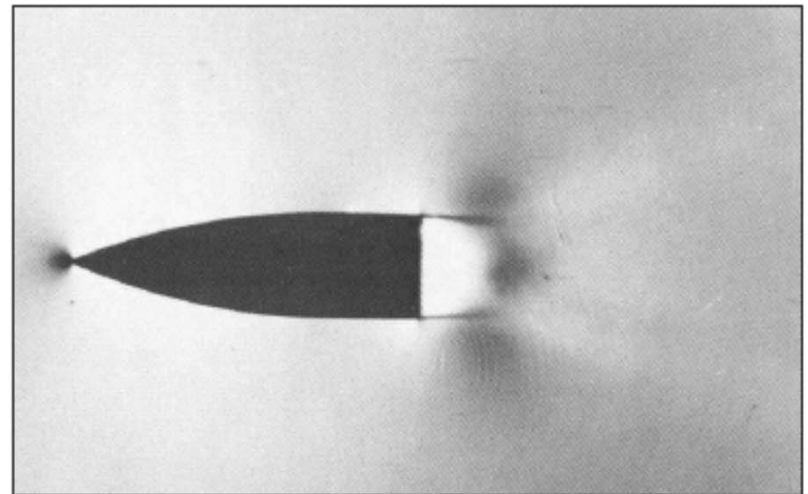

(b)

One-, Two-, and Three-Dimensional Flows

- A flow field is best characterized by its velocity distribution.
- A flow is said to be one-, two-, or three-dimensional if the flow velocity varies in one, two, or three dimensions, respectively.
- However, the variation of velocity in certain directions can be small relative to the variation in other directions and can be ignored.

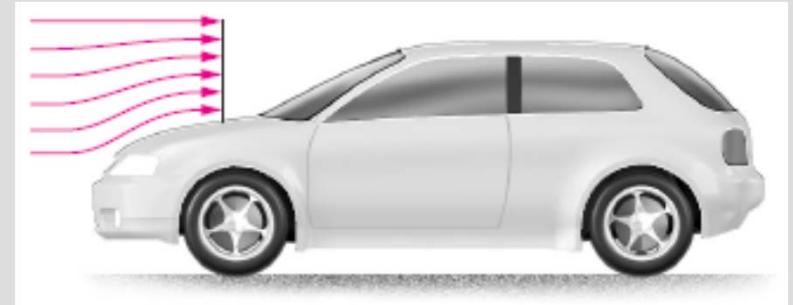

Flow over a car antenna is approximately two-dimensional except near the top and bottom of the antenna.

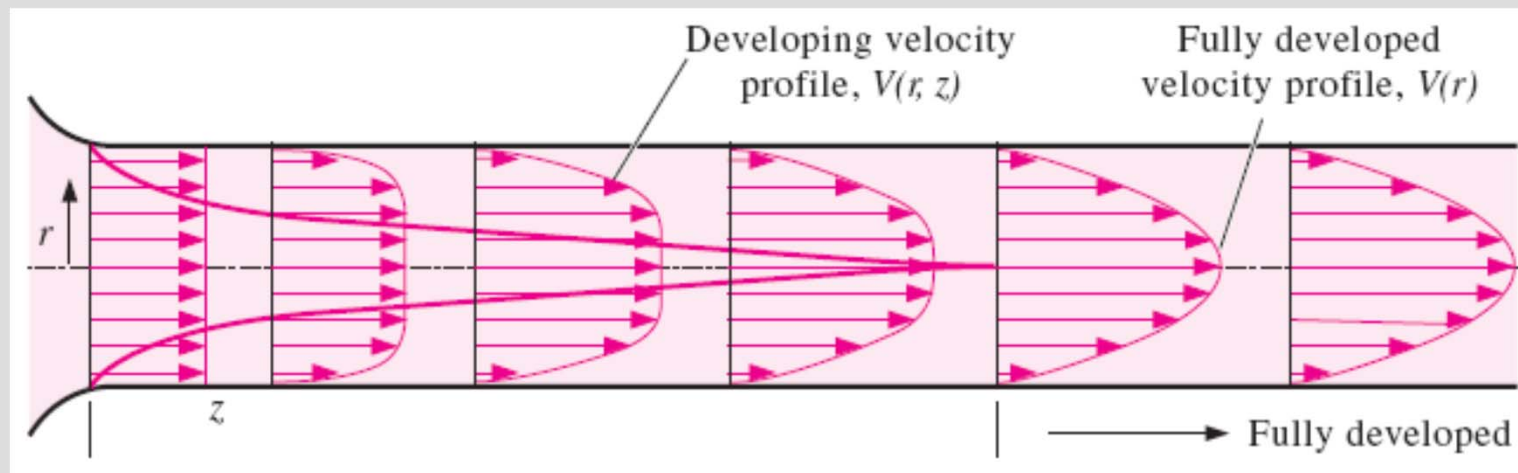

The development of the velocity profile in a circular pipe. $V = V(r, z)$ and thus the flow is two-dimensional in the entrance region, and becomes one-dimensional downstream when the velocity profile fully develops and remains unchanged in the flow direction, $V = V(r)$.

EXAMPLE 1–1 Axisymmetric Flow over a Bullet

Consider a bullet piercing through calm air during a short time interval in which the bullet's speed is nearly constant. Determine if the time-averaged airflow over the bullet during its flight is one-, two-, or three-dimensional (Fig. 1–25).

SOLUTION It is to be determined whether airflow over a bullet is one-, two-, or three-dimensional.

Assumptions There are no significant winds and the bullet is not spinning.

Analysis The bullet possesses an axis of symmetry and is therefore an axisymmetric body. The airflow upstream of the bullet is parallel to this axis, and we expect the time-averaged airflow to be rotationally symmetric about the axis—such flows are said to be axisymmetric. The velocity in this case varies with axial distance z and radial distance r , but not with angle θ . Therefore, the time-averaged airflow over the bullet is **two-dimensional**.

Discussion While the time-averaged airflow is axisymmetric, the *instantaneous* airflow is not, as illustrated in Fig. 1–22. In Cartesian coordinates, the flow would be three-dimensional.

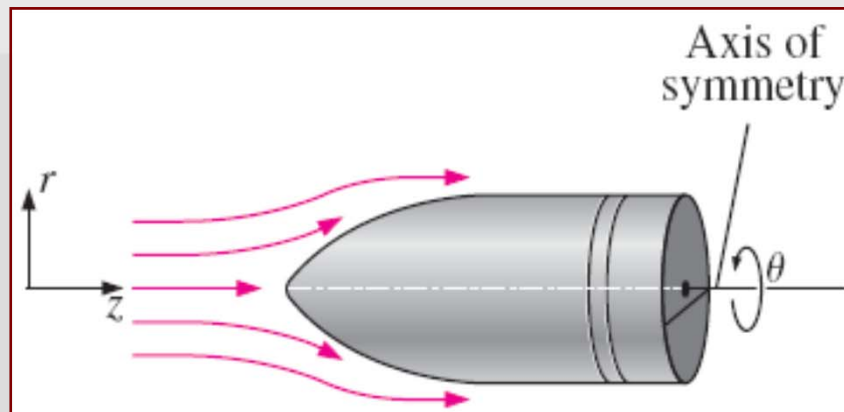

1–5 ■ SYSTEM AND CONTROL VOLUME

- **System:** A quantity of matter or a region in space chosen for study.
- **Surroundings:** The mass or region outside the system
- **Boundary:** The real or imaginary surface that separates the system from its surroundings.
- The boundary of a system can be *fixed* or *movable*.
- Systems may be considered to be *closed* or *open*.
- **Closed system (Control mass):** A fixed amount of mass, and no mass can cross its boundary.

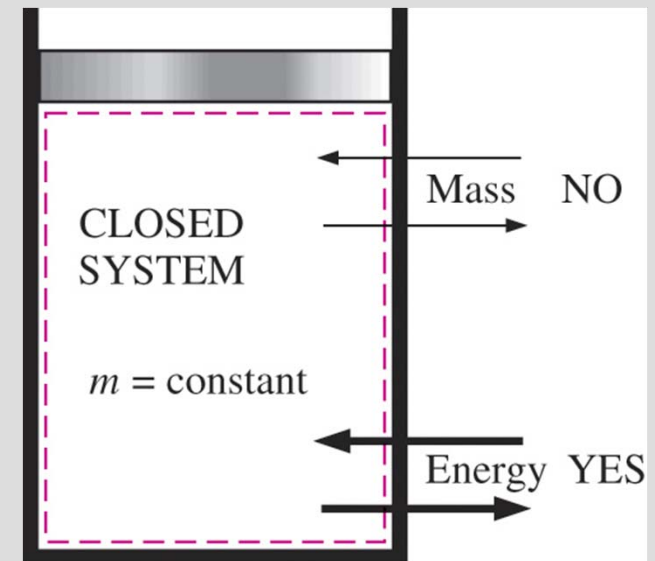
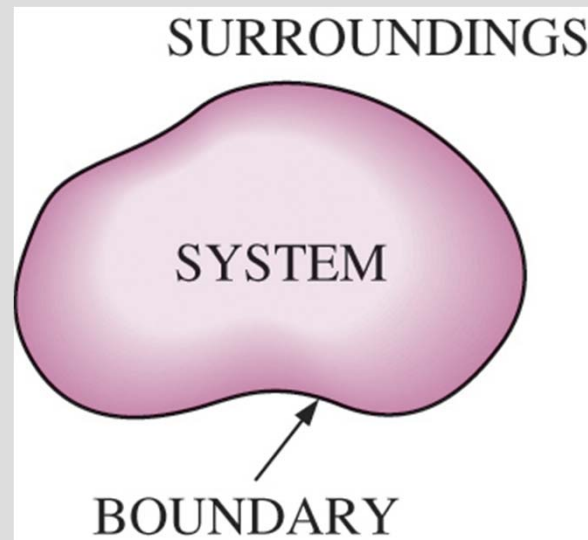
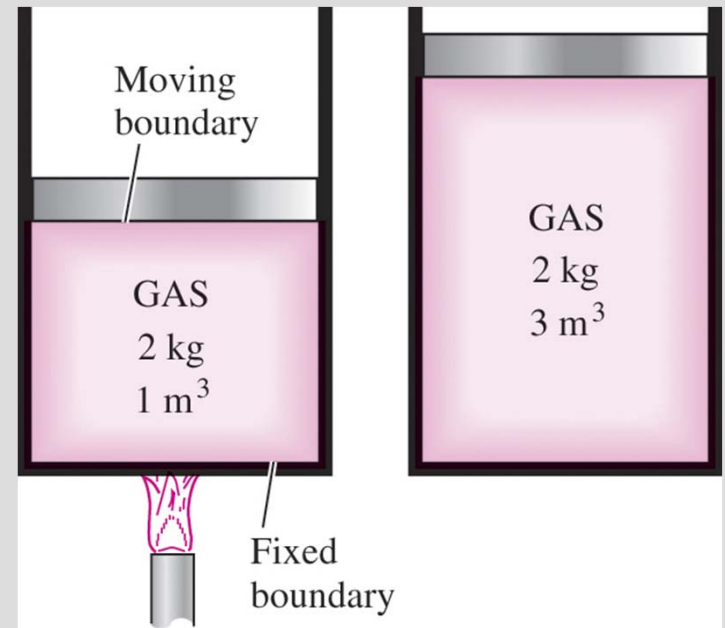

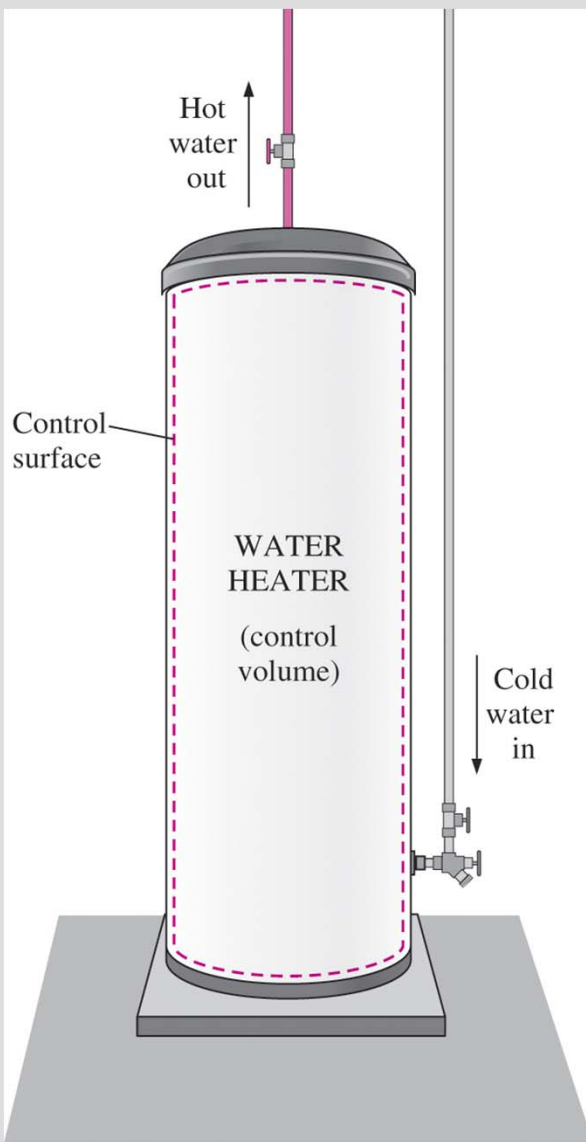

An open system (a control volume) with one inlet and one exit.

- **Open system (control volume):** A properly selected region in space.
- It usually encloses a device that involves mass flow such as a compressor, turbine, or nozzle.
- Both mass and energy can cross the boundary of a control volume.
- **Control surface:** The boundaries of a control volume. It can be real or imaginary.

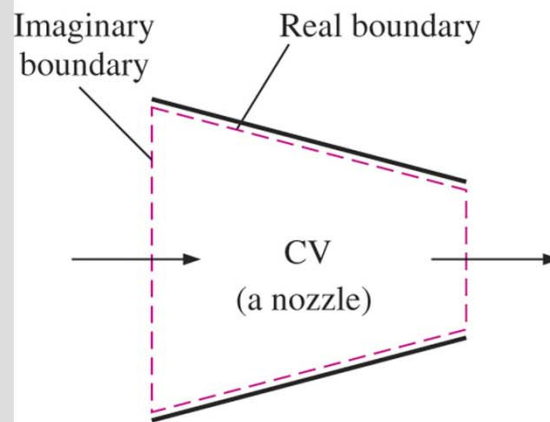

(a) A control volume with real and imaginary boundaries

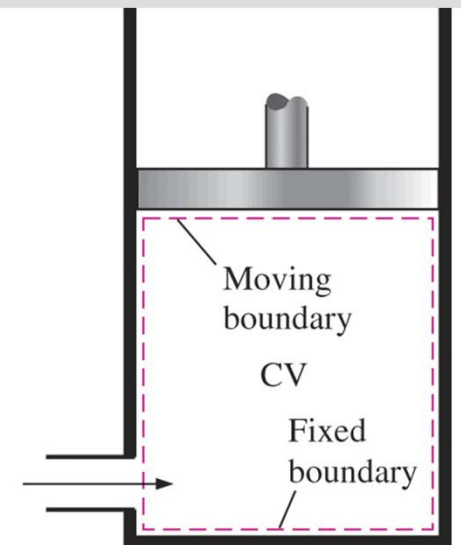

(b) A control volume with fixed and moving boundaries

1–6 ■ IMPORTANCE OF DIMENSIONS AND UNITS

- Any physical quantity can be characterized by **dimensions**.
- The magnitudes assigned to the dimensions are called **units**.
- Some basic dimensions such as mass m , length L , time t , and temperature T are selected as **primary** or **fundamental dimensions**, while others such as velocity V , energy E , and volume V are expressed in terms of the primary dimensions and are called **secondary dimensions**, or **derived dimensions**.
- **Metric SI system:** A simple and logical system based on a decimal relationship between the various units.
- **English system:** It has no apparent systematic numerical base, and various units in this system are related to each other rather arbitrarily.

TABLE 1–1

The seven fundamental (or primary) dimensions and their units in SI

Dimension	Unit
Length	meter (m)
Mass	kilogram (kg)
Time	second (s)
Temperature	kelvin (K)
Electric current	ampere (A)
Amount of light	candela (cd)
Amount of matter	mole (mol)

TABLE 1–2

Standard prefixes in SI units

Multiple	Prefix
10^{12}	tera, T
10^9	giga, G
10^6	mega, M
10^3	kilo, k
10^2	hecto, h
10^1	deka, da
10^{-1}	deci, d
10^{-2}	centi, c
10^{-3}	milli, m
10^{-6}	micro, μ
10^{-9}	nano, n
10^{-12}	pico, p

Some SI and English Units

$$1 \text{ lbm} = 0.45359 \text{ kg}$$

$$1 \text{ ft} = 0.3048 \text{ m}$$

Work = Force \times Distance

$$1 \text{ J} = 1 \text{ N}\cdot\text{m}$$

$$1 \text{ cal} = 4.1868 \text{ J}$$

$$1 \text{ Btu} = 1.0551 \text{ kJ}$$

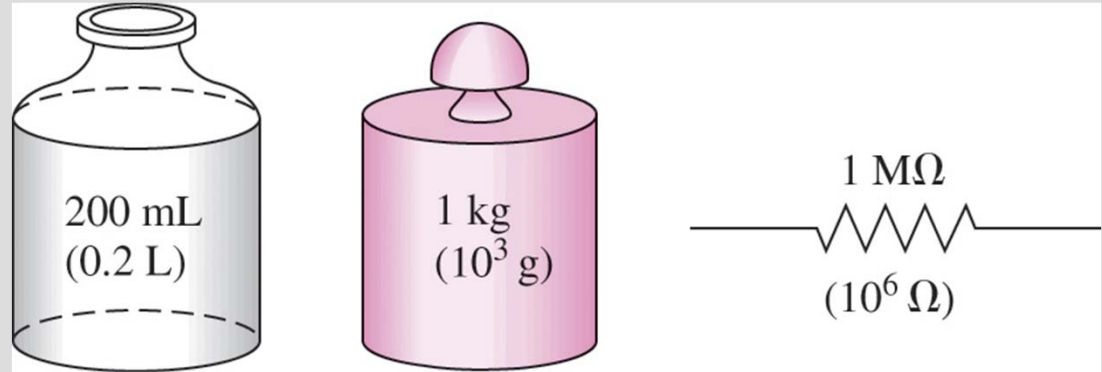

The SI unit prefixes are used in all branches of engineering.

Force = (Mass)(Acceleration)

$$F = ma$$

$$1 \text{ N} = 1 \text{ kg} \cdot \text{m}/\text{s}^2$$

$$1 \text{ lbf} = 32.174 \text{ lbm} \cdot \text{ft}/\text{s}^2$$

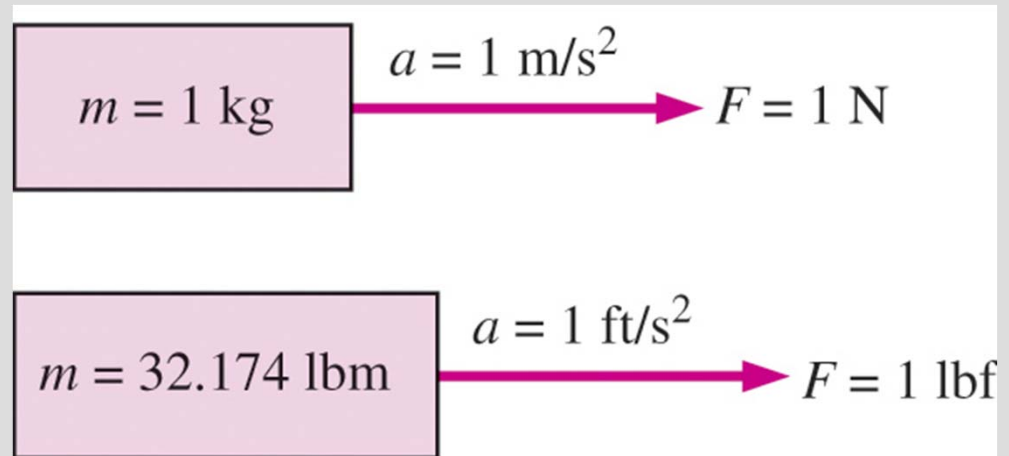

The definition of the force units.



$$W = mg \quad (\text{N})$$

W weight
 m mass
 g gravitational acceleration

A body weighing 60 kgf on earth will weigh only 10 kgf on the moon.

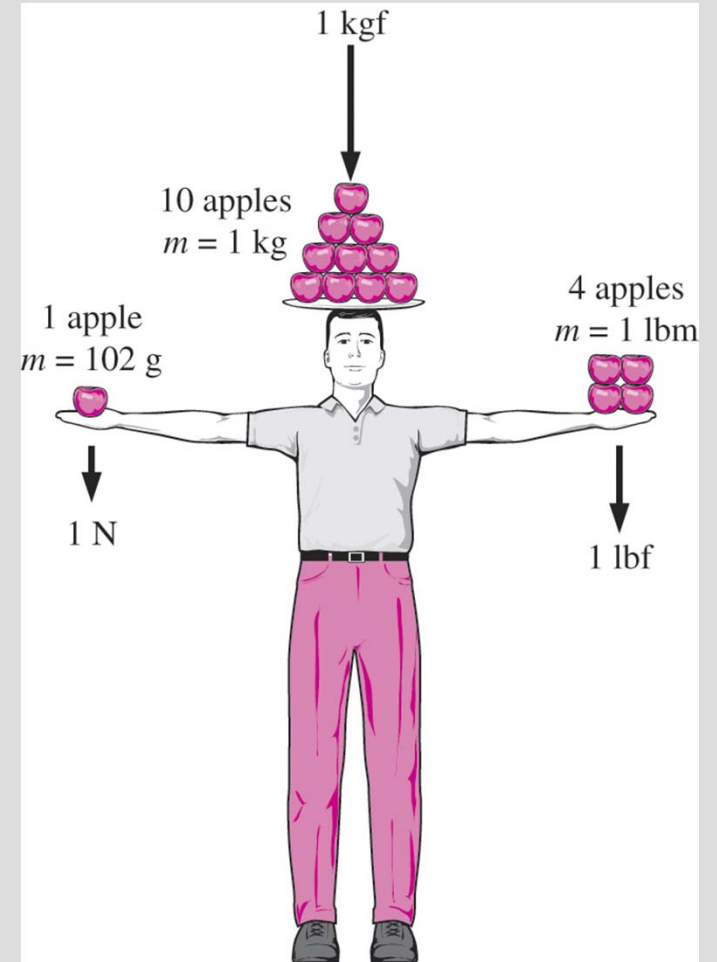

The relative magnitudes of the force units newton (N), kilogram-force (kgf), and pound-force (lbf).

The weight of a unit mass at sea level.

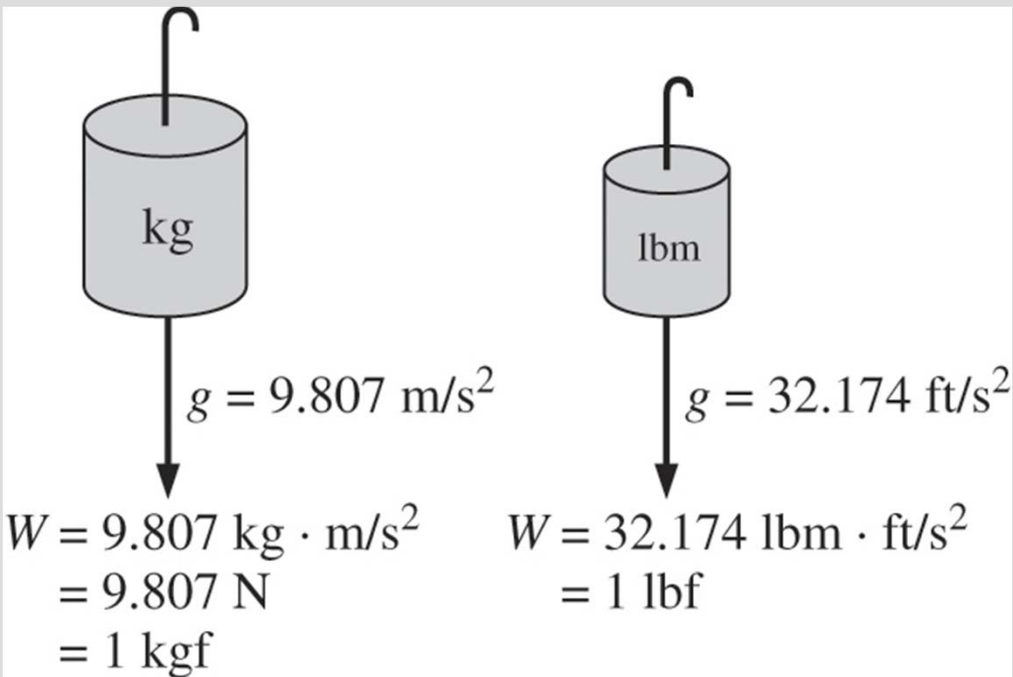

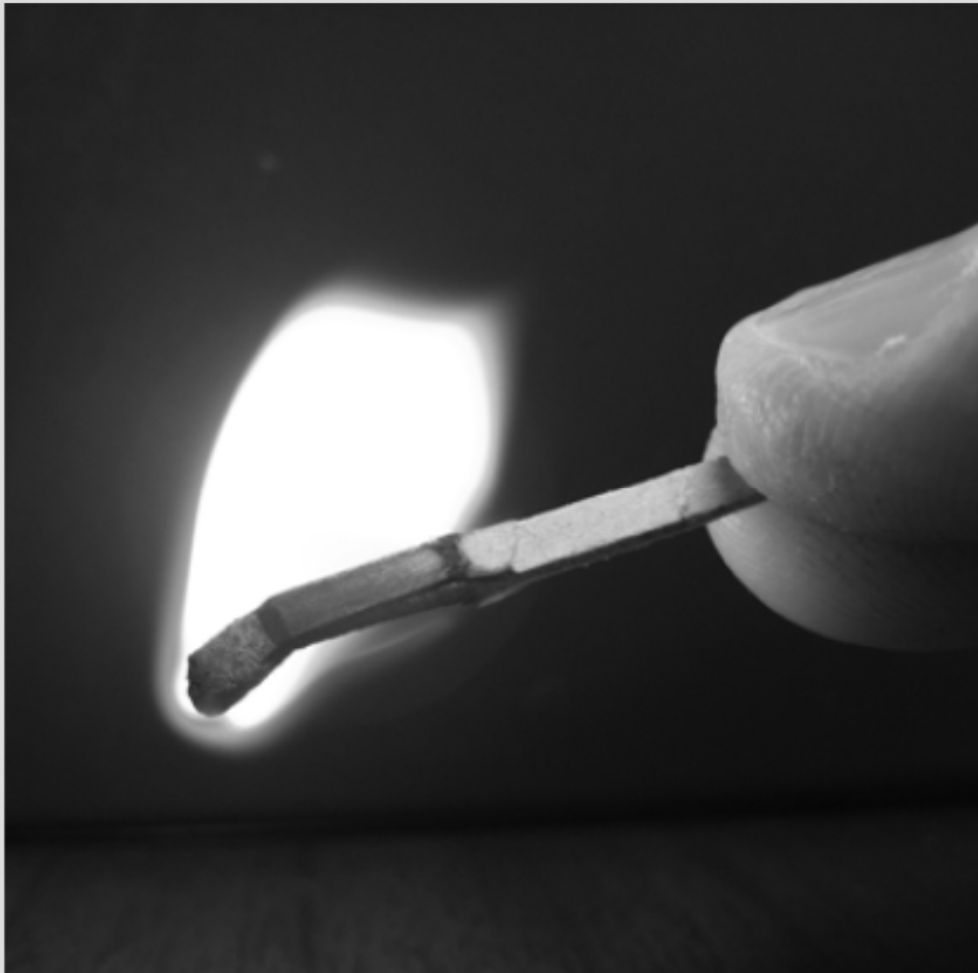

A typical match yields about one Btu (or one kJ) of energy if completely burned.

Dimensional homogeneity

All equations must be dimensionally **homogeneous**.

Unity Conversion Ratios

All nonprimary units (secondary units) can be formed by combinations of primary units.

Force units, for example, can be expressed as

$$\text{N} = \text{kg} \frac{\text{m}}{\text{s}^2} \quad \text{and} \quad \text{lbf} = 32.174 \text{ lbm} \frac{\text{ft}}{\text{s}^2}$$

They can also be expressed more conveniently as **unity conversion ratios** as:

$$\frac{\text{N}}{\text{kg} \cdot \text{m}/\text{s}^2} = 1 \quad \text{and} \quad \frac{\text{lbf}}{32.174 \text{ lbm} \cdot \text{ft}/\text{s}^2} = 1$$

Unity conversion ratios are identically equal to 1 and are unitless, and thus such ratios (or their inverses) can be inserted conveniently into any calculation to properly convert units.

CAUTION!

EVERY TERM IN AN
EQUATION MUST HAVE
THE SAME UNITS

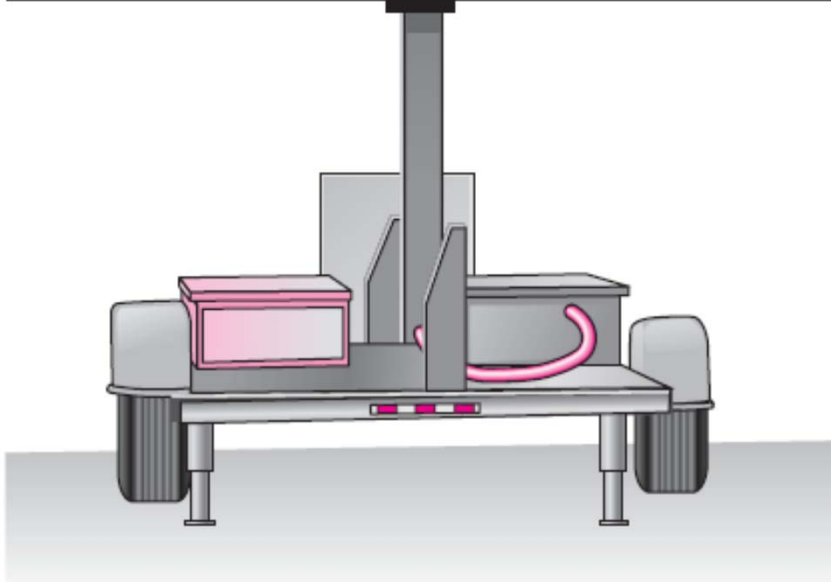

Always check the units in your calculations.

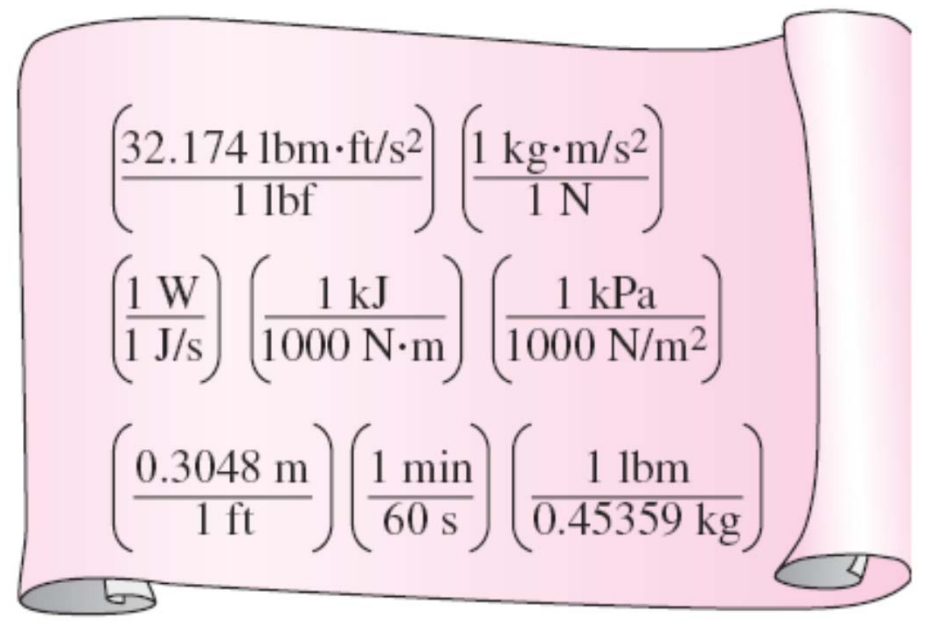

Every unity conversion ratio (as well as its inverse) is exactly equal to one. Shown here are a few commonly used unity conversion ratios.

A quirk in
the metric
system of
units.

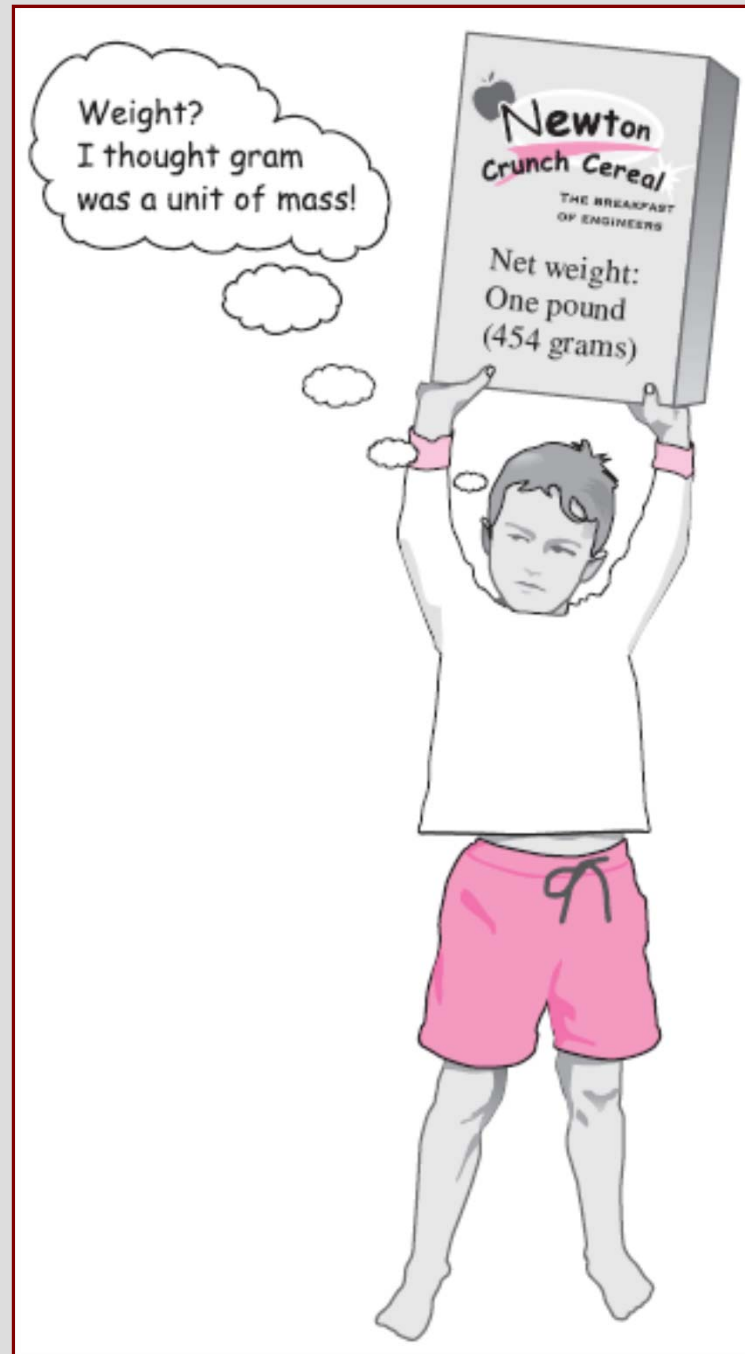

EXAMPLE 1-2 Electric Power Generation by a Wind Turbine

A school is paying \$0.09/kWh for electric power. To reduce its power bill, the school installs a wind turbine (Fig 1-36) with a rated power of 30 kW. If the turbine operates 2200 hours per year at the rated power, determine the amount of electric power generated by the wind turbine and the money saved by the school per year.

SOLUTION A wind turbine is installed to generate electricity. The amount of electric energy generated and the money saved per year are to be determined.

Analysis The wind turbine generates electric energy at a rate of 30 kW or 30 kJ/s. Then the total amount of electric energy generated per year becomes

$$\begin{aligned}\text{Total energy} &= (\text{Energy per unit time})(\text{Time interval}) \\ &= (30 \text{ kW})(2200 \text{ h}) \\ &= \mathbf{66,000 \text{ kWh}}\end{aligned}$$

The money saved per year is the monetary value of this energy determined as

$$\begin{aligned}\text{Money saved} &= (\text{Total energy})(\text{Unit cost of energy}) \\ &= (66,000 \text{ kWh})(\$0.09/\text{kWh}) \\ &= \mathbf{\$5940}\end{aligned}$$

Discussion The annual electric energy production also could be determined in kJ by unit manipulations as

$$\text{Total energy} = (30 \text{ kW})(2200 \text{ h})\left(\frac{3600 \text{ s}}{1 \text{ h}}\right)\left(\frac{1 \text{ kJ/s}}{1 \text{ kW}}\right) = 2.38 \times 10^8 \text{ kJ}$$

which is equivalent to 66,000 kWh (1 kWh = 3600 kJ).



EXAMPLE 1–3 Obtaining Formulas from Unit Considerations

A tank is filled with oil whose density is $\rho = 850 \text{ kg/m}^3$. If the volume of the tank is $V = 2 \text{ m}^3$, determine the amount of mass m in the tank.

SOLUTION The volume of an oil tank is given. The mass of oil is to be determined.

Assumptions Oil is a nearly incompressible substance and thus its density is constant.

Analysis A sketch of the system just described is given in Fig. 1–37. Suppose we forgot the formula that relates mass to density and volume. However, we know that mass has the unit of kilograms. That is, whatever calculations we do, we should end up with the unit of kilograms. Putting the given information into perspective, we have

$$\rho = 850 \text{ kg/m}^3 \quad \text{and} \quad V = 2 \text{ m}^3$$

It is obvious that we can eliminate m^3 and end up with kg by multiplying these two quantities. Therefore, the formula we are looking for should be

$$m = \rho V$$

Thus,

$$m = (850 \text{ kg/m}^3)(2 \text{ m}^3) = \mathbf{1700 \text{ kg}}$$

OIL

$$V = 2 \text{ m}^3$$

$$\rho = 850 \text{ kg/m}^3$$

$$m = ?$$

EXAMPLE 1-4 The Weight of One Pound-Mass

Using unity conversion ratios, show that 1.00 lbm weighs 1.00 lbf on earth (Fig. 1-40).

Solution A mass of 1.00 lbm is subjected to standard earth gravity. Its weight in lbf is to be determined.

Assumptions Standard sea-level conditions are assumed.

Properties The gravitational constant is $g = 32.174 \text{ ft/s}^2$.

Analysis We apply Newton's second law to calculate the weight (force) that corresponds to the known mass and acceleration. The weight of any object is equal to its mass times the local value of gravitational acceleration. Thus,

$$W = mg = (1.00 \text{ lbm})(32.174 \text{ ft/s}^2) \left(\frac{1 \text{ lbf}}{32.174 \text{ lbm} \cdot \text{ft/s}^2} \right) = 1.00 \text{ lbf}$$

Discussion The quantity in large parentheses in this equation is a unity conversion ratio. Mass is the same regardless of its location. However, on some other planet with a different value of gravitational acceleration, the weight of 1 lbm would differ from that calculated here.



1–7 ■ MATHEMATICAL MODELING OF ENGINEERING PROBLEMS

Experimental vs. Analytical Analysis

An engineering device or process can be studied either *experimentally* (testing and taking measurements) or *analytically* (by analysis or calculations).

The **experimental approach** has the advantage that we deal with the actual physical system, and the desired quantity is determined by measurement, within the limits of experimental error. However, this approach is expensive, time-consuming, and often impractical.

The **analytical approach** (including the numerical approach) has the advantage that it is fast and inexpensive, but the results obtained are subject to the accuracy of the assumptions, approximations, and idealizations made in the analysis.

Modeling in Engineering

Why do we need differential equations? The descriptions of most scientific problems involve equations that relate the changes in some key variables to each other.

In the limiting case of infinitesimal or differential changes in variables, we obtain *differential equations* that provide precise mathematical formulations for the physical principles and laws by representing the rates of change as *derivatives*.

Therefore, differential equations are used to investigate a wide variety of problems in sciences and engineering.

Do we always need differential equations? Many problems encountered in practice can be solved without resorting to differential equations and the complications associated with them.

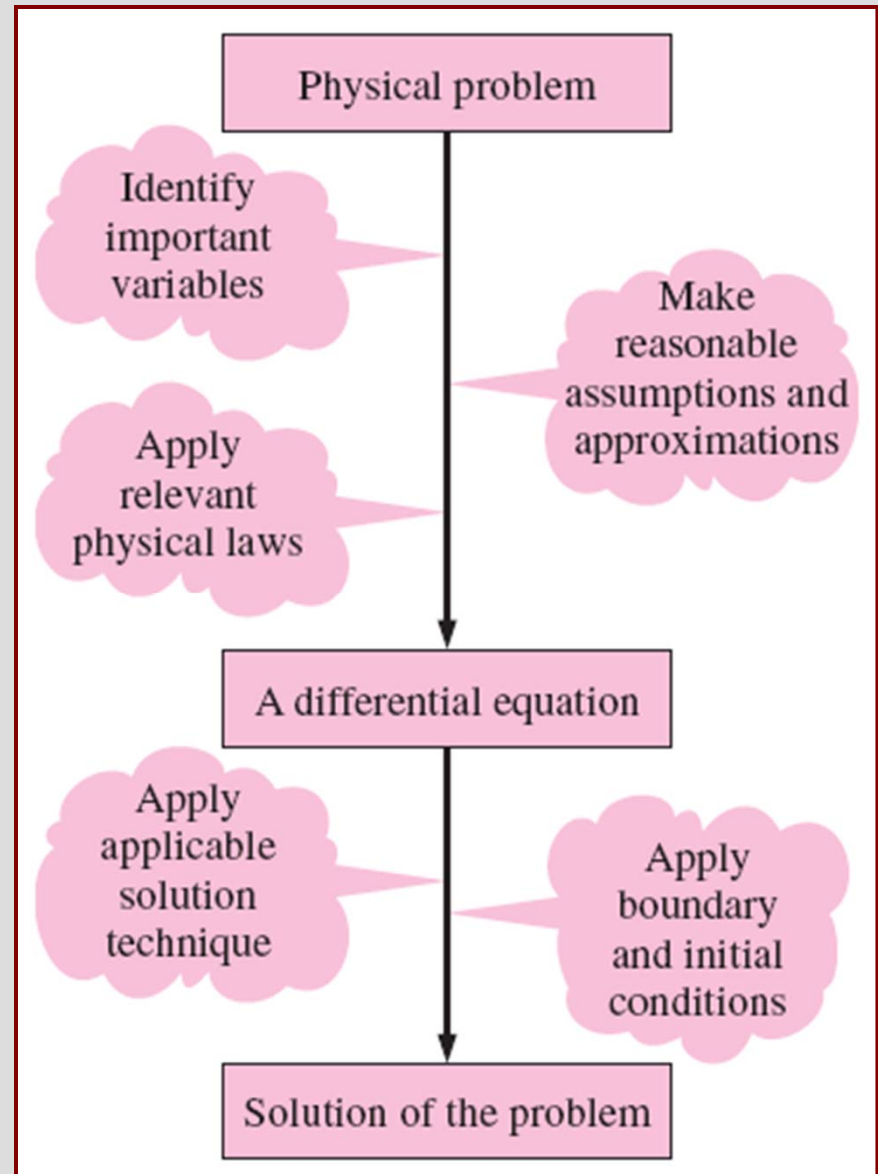

Mathematical modeling of physical problems.



(a) Actual engineering problem

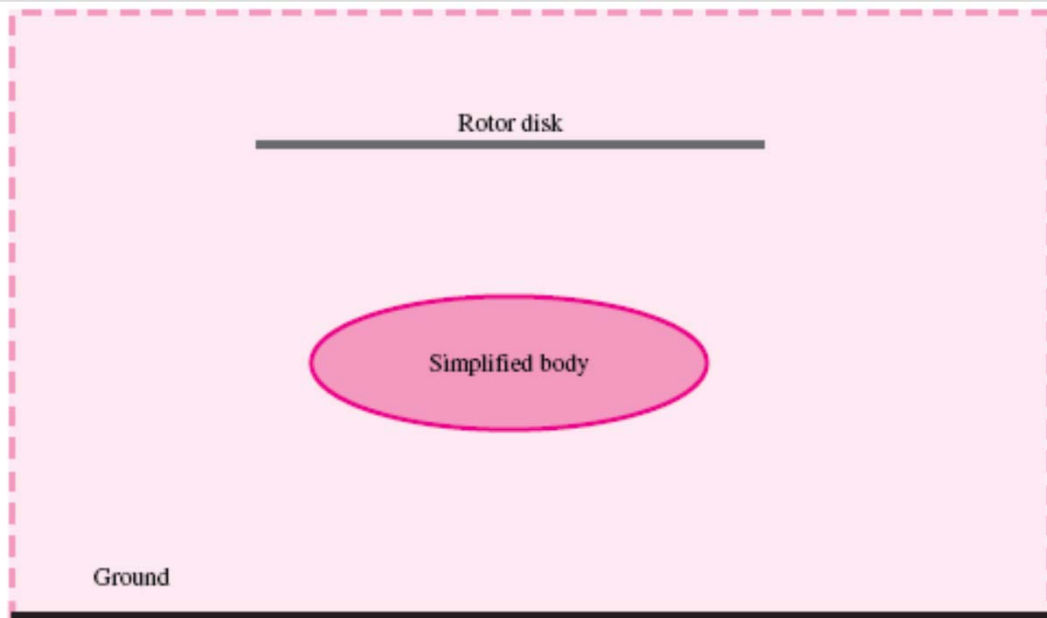

(b) Minimum essential model of the engineering problem

Complex model

(very accurate)

vs.

Simple model

(not-so-accurate)

Simplified models are often used in fluid mechanics to obtain approximate solutions to difficult engineering problems.

Here, the helicopter's rotor is modeled by a disk, across which is imposed a sudden change in pressure. The helicopter's body is modeled by a simple ellipsoid. This simplified model yields the essential features of the overall air flow field in the vicinity of the ground.

The right choice is usually the simplest model that yields satisfactory results.

1–8 ■ PROBLEM-SOLVING TECHNIQUE

- Step 1: Problem Statement
- Step 2: Schematic
- Step 3: Assumptions and Approximations
- Step 4: Physical Laws
- Step 5: Properties
- Step 6: Calculations
- Step 7: Reasoning, Verification, and Discussion

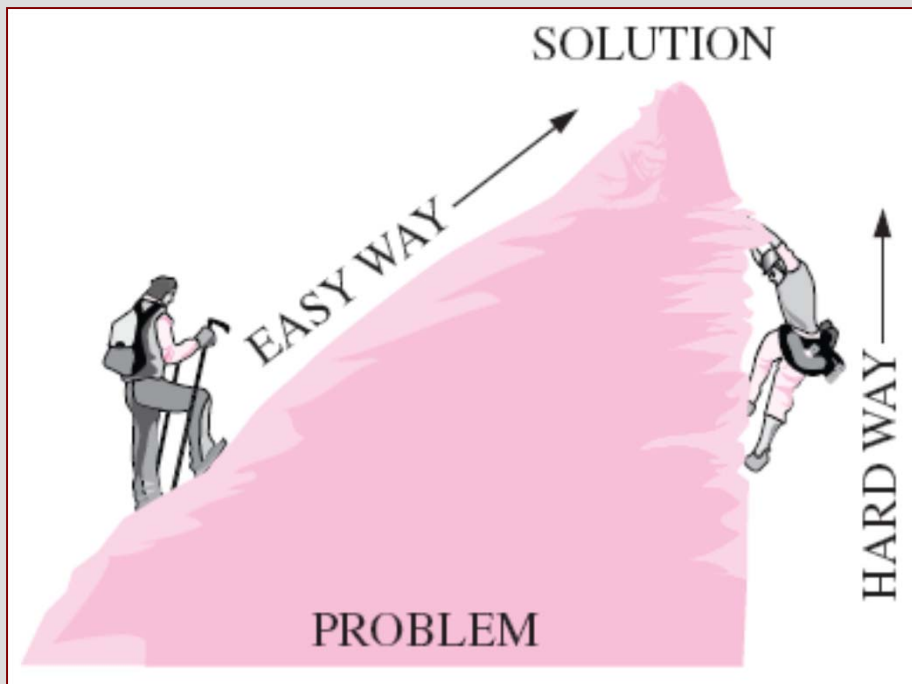

A step-by-step approach can greatly simplify problem solving.

Given: Air temperature in Denver

To be found: Density of air

Missing information: Atmospheric pressure

Assumption #1: Take $P = 1$ atm
(Inappropriate. Ignores effect of altitude. Will cause more than 15% error.)

Assumption #2: Take $P = 0.83$ atm
(Appropriate. Ignores only minor effects such as weather.)

The assumptions made while solving an engineering problem must be reasonable and justifiable.

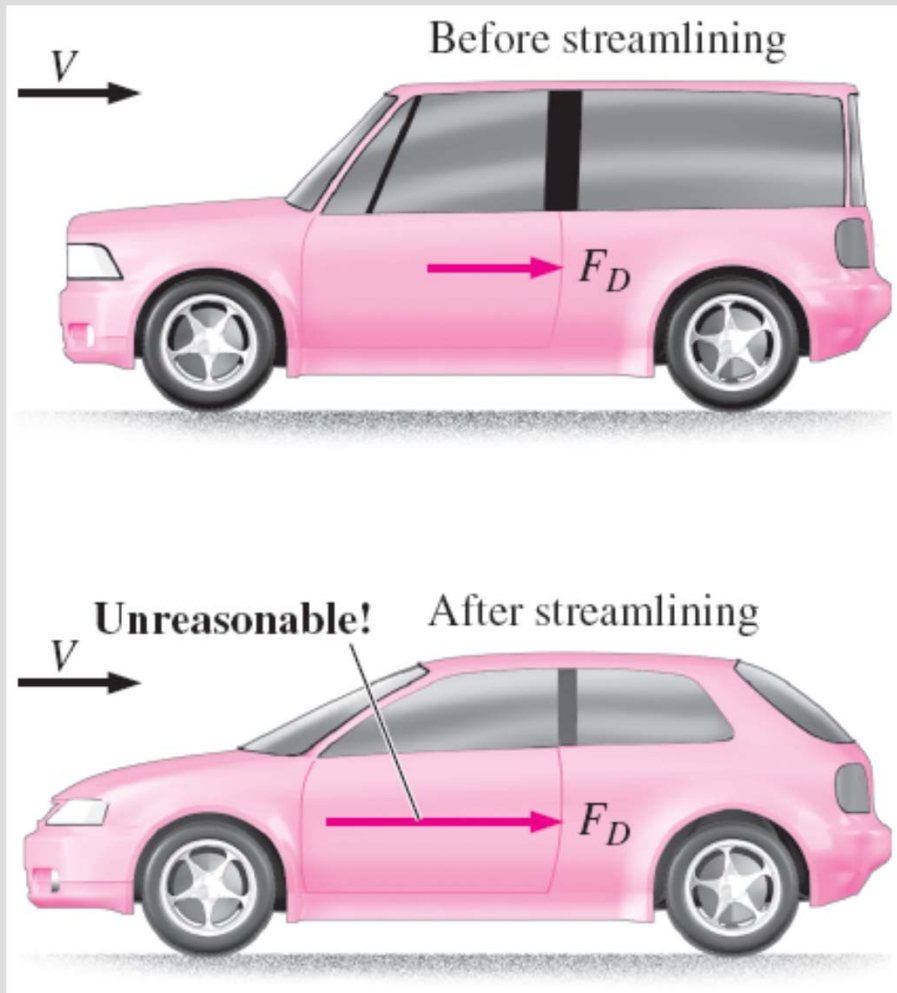

The results obtained from an engineering analysis must be checked for reasonableness.



Neatness and organization are highly valued by employers.

1-9 ■ ENGINEERING SOFTWARE PACKAGES

We should always remember that all the computing power and the engineering software packages available today are just *tools*, and tools have meaning only in the hands of masters.

Hand calculators did not eliminate the need to teach our children how to add or subtract, and sophisticated medical software packages did not take the place of medical school training.

Neither will engineering software packages replace the traditional engineering education. They will simply cause a shift in emphasis in the courses from mathematics to physics. That is, more time will be spent in the classroom discussing the physical aspects of the problems in greater detail, and less time on the mechanics of solution procedures.

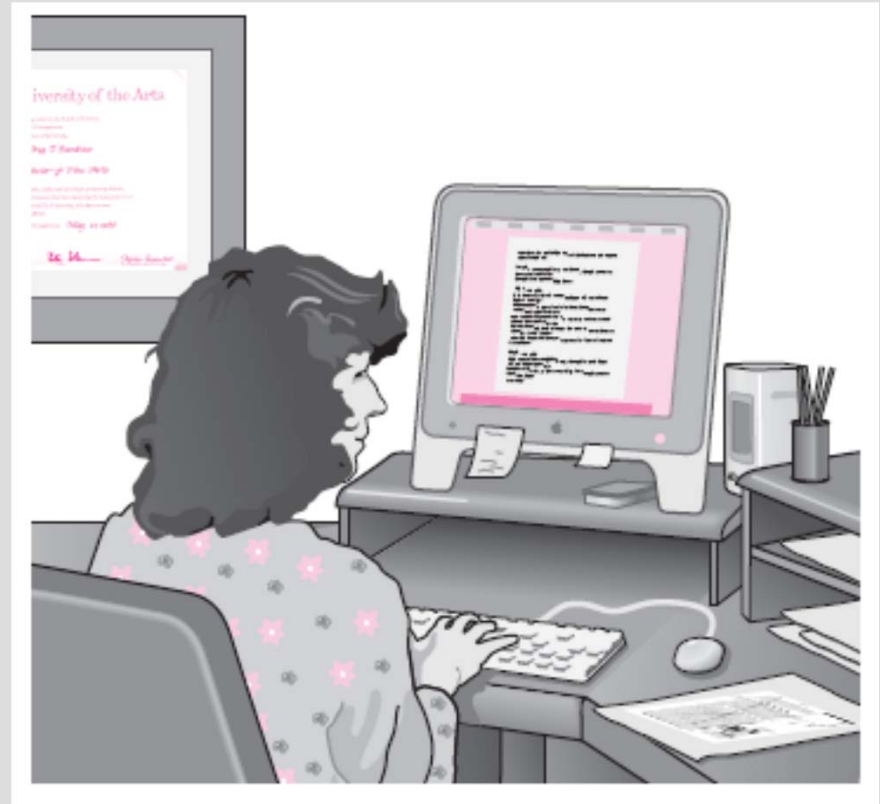

An excellent word-processing program does not make a person a good writer; it simply makes a good writer a more efficient writer.

EES (Engineering Equation Solver)

(Pronounced as ease):

EES is a program that solves systems of linear or nonlinear algebraic or differential equations numerically.

It has a large library of built-in thermodynamic property functions as well as mathematical functions.

Unlike some software packages, EES does not solve engineering problems; it only solves the equations supplied by the user.

EXAMPLE 1-5 Solving a System of Equations with EES

The difference of two numbers is 4, and the sum of the squares of these two numbers is equal to the sum of the numbers plus 20. Determine these two numbers.

SOLUTION Relations are given for the difference and the sum of the squares of two numbers. They are to be determined.

Analysis We start the EES program by double-clicking on its icon, open a new file, and type the following on the blank screen that appears:

$$\begin{aligned}x - y &= 4 \\ x^2 + y^2 &= x + y + 20\end{aligned}$$

which is an exact mathematical expression of the problem statement with x and y denoting the unknown numbers. The solution to this system of two nonlinear equations with two unknowns is obtained by a single click on the “calculator” icon on the taskbar. It gives (Fig. 1-49)

$$x = 5 \quad \text{and} \quad y = 1$$

Discussion Note that all we did is formulate the problem as we would on paper; EES took care of all the mathematical details of solution. Also note that equations can be linear or nonlinear, and they can be entered in any order with unknowns on either side. Friendly equation solvers such as EES allow the user to concentrate on the physics of the problem without worrying about the mathematical complexities associated with the solution of the resulting system of equations.

FlowLab

It is important for beginning students of fluid mechanics to become familiar with **computational fluid dynamics (CFD)**.

FlowLab is a student-oriented CFD software package that utilizes predesigned templates that enable virtually anyone to run a CFD code and generate results.

FlowLab is based on the commercial CFD program from **ANSYS** called **FLUENT**; you will see FlowLab end-of-chapter problems throughout this textbook.

Each problem is designed with two objectives:

- (1) learn or emphasize a fluid mechanics concept
- (2) become familiar with running a user-friendly CFD code

1–10 ■ ACCURACY, PRECISION, AND SIGNIFICANT DIGITS

Accuracy error (*inaccuracy*): The value of one reading minus the true value. In general, accuracy of a set of measurements refers to the closeness of the average reading to the true value. Accuracy is generally associated with repeatable, fixed errors.

Precision error: The value of one reading minus the average of readings. In general, precision of a set of measurements refers to the fineness of the resolution and the repeatability of the instrument. Precision is generally associated with unrepeatable, random errors.

Significant digits: Digits that are relevant and meaningful.

Illustration of accuracy versus precision.
Shooter A is more precise, but less accurate, while shooter B is more accurate, but less precise.

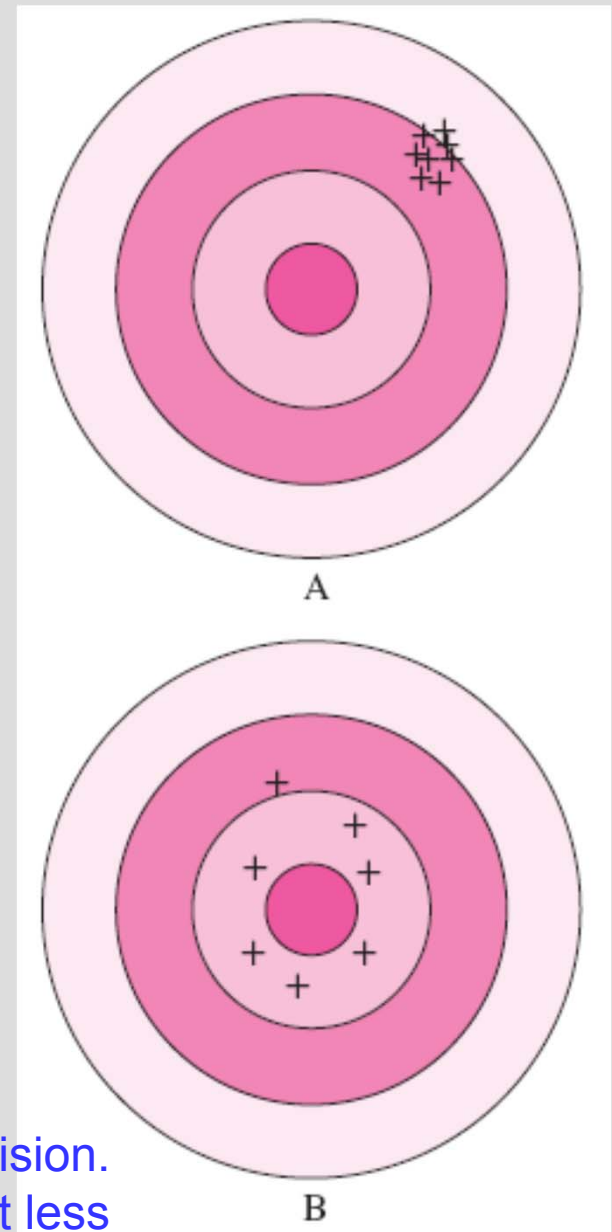

TABLE 1–3**Significant digits**

Number	Exponential Notation	Number of Significant Digits
12.3	1.23×10^1	3
123,000	1.23×10^5	3
0.00123	1.23×10^{-3}	3
40,300	4.03×10^4	3
40,300.	4.0300×10^4	5
0.005600	5.600×10^{-3}	4
0.0056	5.6×10^{-3}	2
0.006	$6. \times 10^{-3}$	1

Given: Volume: $V = 3.75 \text{ L}$

Density: $\rho = 0.845 \text{ kg/L}$

(3 significant digits)

Also, $3.75 \times 0.845 = 3.16875$

Find: Mass: $m = \rho V = 3.16875 \text{ kg}$

Rounding to 3 significant digits:

$m = 3.17 \text{ kg}$

A result with more significant digits than that of given data falsely implies more precision.

Exact time span = 45.623451 ... s

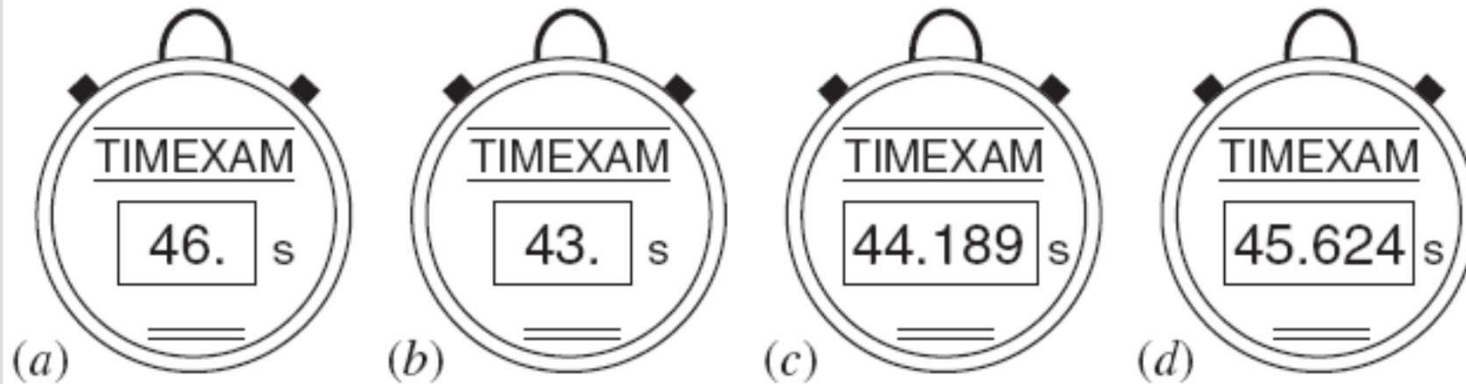

An instrument with many digits of resolution (stopwatch *c*) may be less accurate than an instrument with few digits of resolution (stopwatch *a*). What can you say about stopwatches *b* and *d*?

EXAMPLE 1–6 Significant Digits and Volume Flow Rate

Jennifer is conducting an experiment that uses cooling water from a garden hose. In order to calculate the volume flow rate of water through the hose, she times how long it takes to fill a container (Fig. 1–52). The volume of water collected is $V = 1.1$ gal in time period $\Delta t = 45.62$ s, as measured with a stopwatch. Calculate the volume flow rate of water through the hose in units of cubic meters per minute.

SOLUTION Volume flow rate is to be determined from measurements of volume and time period.

Assumptions 1 Jennifer recorded her measurements properly, such that the volume measurement is precise to two significant digits while the time period is precise to four significant digits. 2 No water is lost due to splashing out of the container.

Analysis Volume flow rate \dot{V} is volume displaced per unit time and is expressed as

$$\text{Volume flow rate:} \quad \dot{V} = \frac{\Delta V}{\Delta t}$$

Substituting the measured values, the volume flow rate is determined to be

$$\dot{V} = \frac{1.1 \text{ gal}}{45.62 \text{ s}} \left(\frac{3.785 \times 10^{-3} \text{ m}^3}{1 \text{ gal}} \right) \left(\frac{60 \text{ s}}{1 \text{ min}} \right) = 5.5 \times 10^{-3} \text{ m}^3/\text{min}$$

Discussion The final result is listed to two significant digits since we cannot be confident of any more precision than that. If this were an intermediate step in subsequent calculations, a few extra digits would be carried along to avoid accumulated round-off error. In such a case, the volume flow rate would be written as $\dot{V} = 5.4759 \times 10^{-3} \text{ m}^3/\text{min}$. Based on the given information, we cannot say anything about the *accuracy* of our result, since we have no information about systematic errors in either the volume measurement or the time measurement.

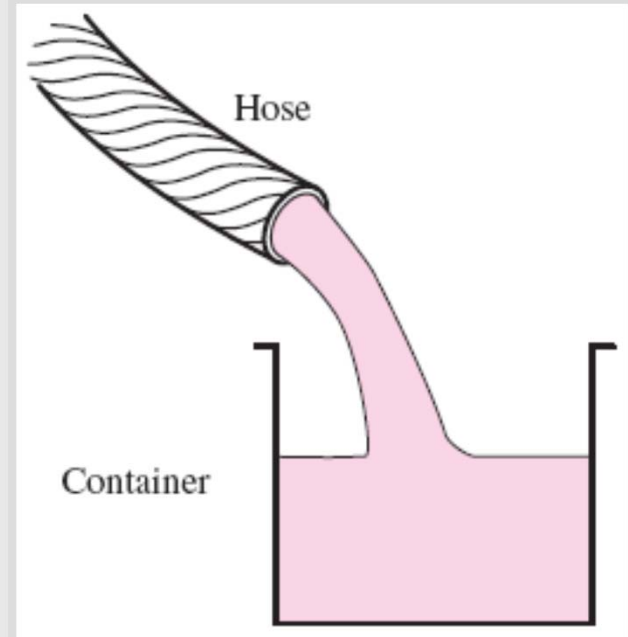

Summary

- The No-Slip Condition
- A Brief History of Fluid Mechanics
- Classification of Fluid Flows
 - ✓ Viscous versus Inviscid Regions of Flow
 - ✓ Internal versus External Flow
 - ✓ Compressible versus Incompressible Flow
 - ✓ Laminar versus Turbulent Flow
 - ✓ Natural (or Unforced) versus Forced Flow
 - ✓ Steady versus Unsteady Flow
 - ✓ One-, Two-, and Three-Dimensional Flows
- System and Control Volume
- Importance of Dimensions and Units
- Mathematical Modeling of Engineering Problems
- Problem Solving Technique
- Engineering Software Packages
- Accuracy, Precision and Significant Digits