

# In-Situ Characterization of rocks

Editors: V.M. Sharma and K.R. Saxena

(2001) A. A. BALKEMA PUBLISHERS LISE / ABINGDON / EXTON (PA) / TOKIO

## Chapter 2

### MEASUREMENT AND CHARACTERIZATION OF ROCK MASS JOINTING

by

Arild Palmström,  
Övre Smestad vei 35e, N-0378 Oslo, Norway

#### **Summary**

This chapter concentrates on various measurements and the characterization of the degree of jointing, i.e. the density and condition of joints within a rock mass volume. Block size is generally the most important feature influencing the behaviour of rock masses in underground openings and surface cuttings. Therefore, reliable measurements of the rock blocks govern the quality of assessments in rock mechanics, rock engineering, and numerical modelling. The following methods for measuring the *degree of jointing* and the block size, together with correlations between them, are described:

- Observation of exposed (sound) rocks in the surface or in excavations.
- Logging of drill cores, where the distance between joints (joint intercept), the RQD, joint frequency (number of joints per metre) are noted.
- Evaluation of joint density from seismic velocities in profiles.
- The weighted jointing method, which improves measurements made on rock surfaces and on drill cores.

The following measurements of the *joint conditions* have been described:

- Joint roughness, composed of smoothness of joint surface and waviness of joint plane.
- Joint alteration, composed of the condition of the joint wall and possible joint filling or coating on joint wall.
- Joint size and termination.

Tables with descriptions and ratings of these joint parameters are shown.

Jointing measurements and characterization apply often different terms for the joint features, which frequently leads to confusions, misunderstanding and inaccuracy. Definitions of the various types of discontinuities, and of other expressions are therefore presented.

## Table of content

1.	<b>INTRODUCTION</b> .....	3
2.	<b>THE MAIN FEATURES OF JOINTS AND JOINTING</b> .....	5
2.1	Definitions .....	5
3.	<b>MEASUREMENTS OF THE DEGREE OF JOINTING</b> .....	8
3.1	Some comments on joint spacing .....	8
3.2	Blocks formed by the joints.....	8
3.2.1	Block types and shapes.....	9
3.3	Measurements of the block volume ( $V_b$ ) .....	10
3.3.1	Directly on site or from drill cores .....	10
3.3.2	From joint set spacings.....	10
3.3.3	Method where joints do not seem to delimit blocks .....	10
3.4	Measurements of the volumetric joint count ( $J_v$ ) .....	11
3.4.1	From joint set spacings.....	11
3.4.2	From 2-D measurements on an area or surface.....	11
3.4.3	From 1-D measurements along a scanline or drill core .....	12
3.5	Correlation between $V_b$ and $J_v$ .....	12
3.6	Measurement of the rock quality designation (RQD) .....	12
3.7	Correlation between RQD and $J_v$ .....	13
3.8	Block size distribution .....	14
3.9	Example, jointing measurements in surfaces.....	15
3.10	Summing-up measurements of the degree of jointing .....	16
4.	<b>OTHER METHODS TO FIND THE DEGREE OF JOINTING</b> .....	18
4.1	The weighted jointing density (wJd) method .....	18
4.1.1	Principles.....	18
4.1.2	Examples.....	19
4.2	Joint density assessed from seismic velocities .....	21
4.2.1	Introduction.....	21
4.2.2	Alt. 1: The initial correlation method .....	22
4.2.3	Alt. 2: Refined correlation method .....	22
4.2.4	Applications and limitations using seismic velocities .....	24
4.2.5	Examples.....	24
5.	<b>MEASUREMENTS OF THE JOINT CHARACTERISTICS</b> .....	27
5.1	Joint roughness .....	27
5.1.1	Joint planarity or waviness .....	28
5.1.2	Joint smoothness .....	29
5.2	The joint condition or alteration .....	31
5.3	Joint size, termination and persistence .....	32
5.4	The joint condition factor ( $j_C$ ).....	32
6.	<b>UNCERTAINTIES AND ERRORS IN JOINTING MEASUREMENTS</b> .....	34
6.1	Introduction .....	34
6.2	Measurement errors .....	34
6.3	Errors and inaccuracies in core drilling and logging.....	36
6.4	Summing-up uncertainties and errors .....	37
7.	<b>REFERENCES</b> .....	39

## 1. INTRODUCTION

*"Since joints are among the most important causes of excessive overbreak and of trouble with water, they always deserve careful consideration."* Karl Terzaghi, 1946

A rock mass is a material quite different from other structural materials used in civil engineering. Ideally, it is composed of a system of rock blocks and fragments separated by discontinuities forming a material in which all elements behave in mutual dependence as a unit, see Figure 1.

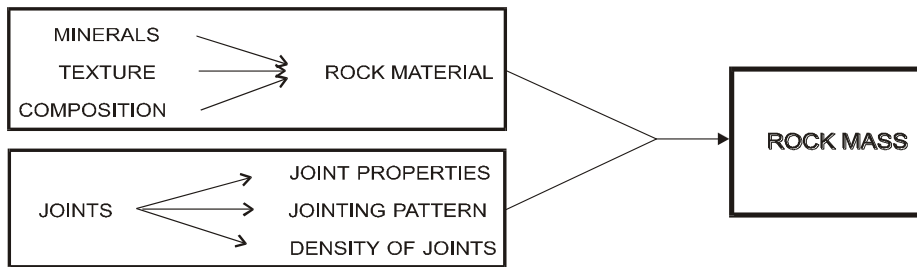

Figure 1 The main features constituting a rock mass.

Large variations in the composition and structure of rocks as well as in the properties and occurrence of the discontinuities intersecting the rock lead to a complicated composition and structure of the rock mass. Testing of rock masses in situ has, therefore, clearly brought out the enormous variations that exist in the mechanical behaviour of a rock mass from place to place. Thus, Brown (1986) is of the opinion that *"inadequacies in site characterisation of geological data probably present the major impediment to the design, construction and operation of excavations in rock. Improvements in site characterisation methodology and techniques, and in the interpretation of the data are of primary research requirements, not only for large rock caverns, but for all forms of rock engineering."*

Caused by this, the properties or characteristics of the material called rock mass are not measured, but estimated from observations, descriptions and indirect tests, supported by laboratory test on small specimens, from which characterizations of relevant parameters in the rock mass are made, see Figure 2.

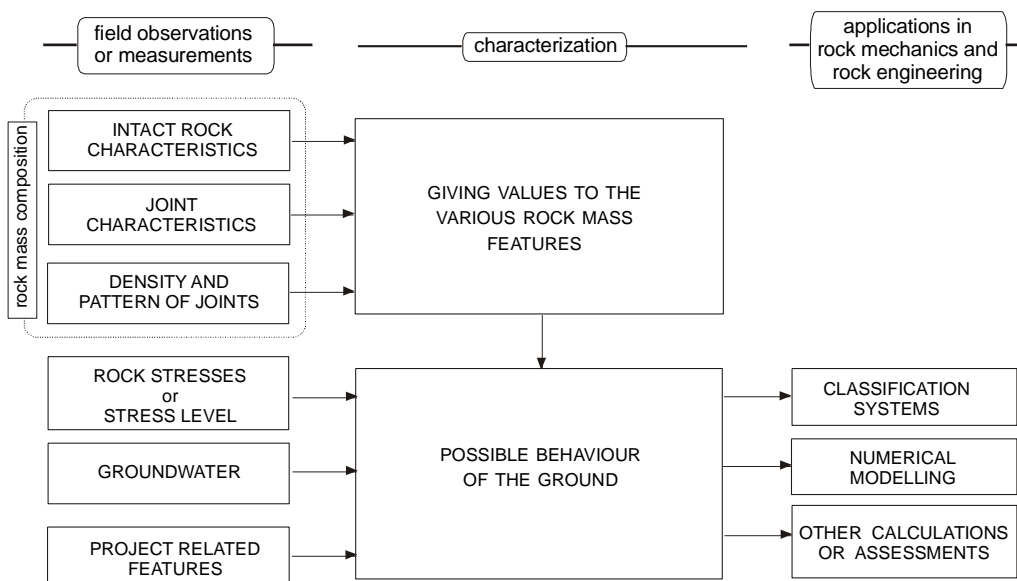

Figure 2 Characterization of the joining forms an important part of rock engineering and rock mechanics as concluded in the discussion in the conference GeoEng2000.

In this connection it is appropriate to make the following definitions:

*Rock mass* is a volume of rock(s) intersected by discontinuities.

*(Rocky) ground* is rock mass subjected to stresses and ground water.

*Characterization* is the process of giving numerical values to rock mass features such as joint density, joint roughness, rock type, etc. from observations or measurements made.

*Classification system* is the application of characterization in rock design.

Important in all rock mechanics, rock engineering and design, is the uncertainties and possible errors connected to the collection of geological information. Some comments on this are given in Chapter 6.

Measurement of strike and dip of joints, as well as calculations of the angle between the various joints or joints or joint sets and the use of joint rosette or stereographic projections in statistical evaluations are not described in this chapter, as these features may be found in textbooks or other available literature.

## 2. THE MAIN FEATURES OF JOINTS AND JOINTING

The following rock mass parameters have generally the strongest impact on the behaviour and strength properties of a rock mass, see Figure 3:

*A. The degree of jointing, including:*

1. density of joints (measured as joint set spacing, block size, RQD); and
2. block shape or jointing pattern;
3. orientation of joint set or main discontinuities;

*B. The joint characteristics, consisting of:*

4. joint roughness (smoothness and waviness or planarity);
  5. joint condition or alteration (condition of joint walls, possible filling material)
- C. The rock material through which the joints intersect (not covered in this chapter):*
6. strength and elastic properties of the rock;
  7. rock anisotropy;
  8. rock durability;
  9. content of certain minerals with special properties (swelling, elastic, soluble, etc.).

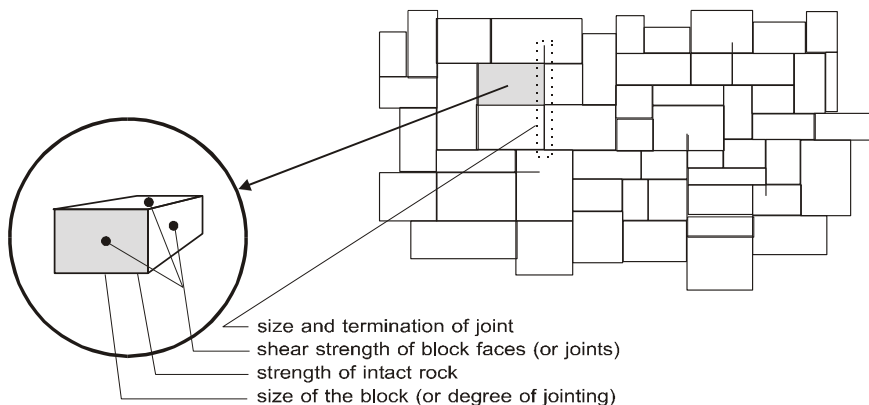

Figure 3 The block size and joint characteristics form the main features in a blocky rock mass (from Palmström, 1995)

The engineering properties of a rock mass depend often far more on the system of geological defects within the rock mass than of the strength of the rock itself. Thus, from an engineering point of view, a knowledge of the type and frequency of the joints and fissures are often more important than the types of rocks involved. The observations and characterization of the joints should therefore be done carefully.

### 2.1 Definitions

There is a difficulty in giving a concise definition of what constitutes a joint. During the years there have been several discussions whether 'joint', 'fracture', 'break' or other terms should be preferred in rock mechanics, engineering geology and rock engineering. ISRM (1975) has chosen 'joint' defined as: "Joint is a discontinuity plane of natural origin along which there has been no visible displacement."

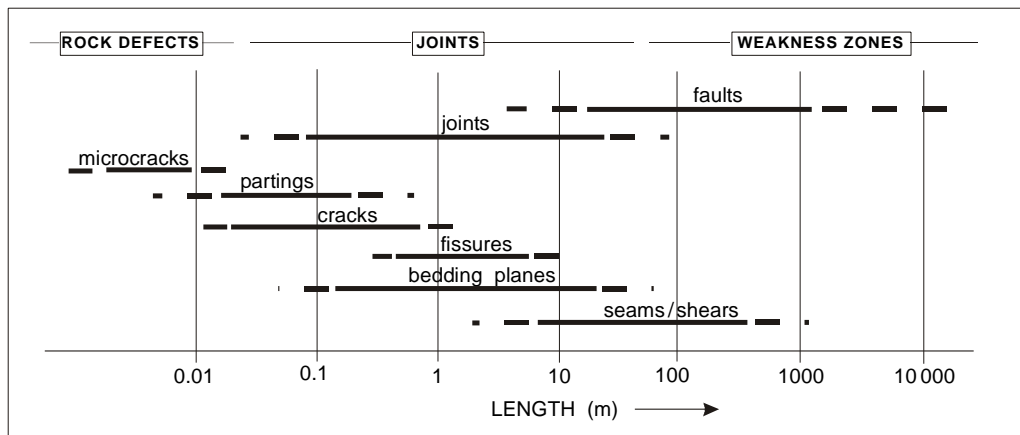

Figure 4 The difference in size between the main types of discontinuities (rock defects, joints and weakness zones). In this chapter joint and weakness zones are used as the two main collective terms for discontinuities.

The terms for the various types of joints in Figure 4 are generally chosen from their size and composition. Some supplementary definitions of these and some other discontinuities are given below:

*Crack* is a small, partial or incomplete discontinuity (ISRM, 1975).

*Fissure* is a small joint, mainly without filling or coating.

*Fracture* is a discontinuity in rock due to intense folding or faulting (Glossary of geology, 1980). Fracture is a general term used in *geology* for all kinds of discontinuities. Hence, this term is seldom used in connection with rock engineering and engineering geology.

*Parting* is a plane or surface along which a rock is readily separated or is naturally divided into layers, i.e. bedding-plane parting (Glossary of geology, 1980). Partings, which often occur as bedding plane and foliation partings, are separations parallel to a mineralogically defined structural weakness in the rock. They are most often tight and rough except where flaky minerals (mica, chlorite) occur.

*Rupture* is a fracture or discontinuity caused by excavation works or other human activities.

*Seam*

- 1) a minor, often clay-filled zone with a thickness of a few centimetres.  
When occurring as weak clay zone in a sedimentary sequence, a seam can be considerably thicker. Otherwise, seams may represent very minor faults or altered zones along joints, dikes, beds or foliation (Brekke and Howard, 1972).
- 2) a plane in a coal bed at which the different layers of coal are easily separated (Dictionary of geological terms, 1962)

*Shear* is a seam of sheared and crushed rock usually spaced more widely than joints and is marked by several millimetres to as much as a metre thickness of soft or friable rock or soil.<sup>1</sup>

*Singularity* is used as a general term for seams, filled joints, shears or other persistent discontinuities which are not considered as belonging to the *detailed jointing*.

*Bedding joints / Bedding partings* are discontinuities developed along the bedding planes in sedimentary rocks.

*Foliation partings / Foliation joints* are discontinuities developed along the foliation planes in metamorphic rocks.

*Tectonic joints* are discontinuities formed from the tensile stresses accompanying uplift or lateral stretching, or from the effects of regional tectonic compression (ISRM, 1975). They commonly occur as planar, rough-surfaced sets of intersecting joints, with one or two of the sets usually dominating in persistence.

(ISRM (1975) advises against the use of the terms *tension joint* and *shear joint*, since there are many possible ways that they can be developed. For example, tension joints can be developed from cooling of igneous rock, from shrinkage of sediments, from folding, or from ice retreat.)

---

*Jointing* is the occurrence of joint sets forming the system or pattern of joints as well as the amount or intensity of joints.

*Detailed jointing* is the network of joints in the massifs between weakness zones.

*Degree of jointing / density of joints* is used as the general term for the amount of joints in a rock mass. This includes block size, joint set spacing, joint frequency, rock quality designation (RQD).

Joints are found in certain, preferred directions as *joint sets* forming the jointing pattern, see Figure 6. One to three prominent joint sets and one or more minor sets often occur; in addition several individual or *random joints* may be present.

### 3. MEASUREMENTS OF THE DEGREE OF JOINTING

The size of the rock mass of interest is generally so large that it is mostly impossible to measure its mechanical properties. Therefore, the best way to obtain information on the joint properties (density and other joints characteristics) of the rock mass is to perform observations in the field or on drill cores. The way such observations are carried out highly determines the quality of the geo-data used in the evaluations and calculations.

The most common methods to assess the degree of jointing or the density of joints are:

- Observations and/or measurements in rock surfaces;
- Observations and/or logging of drill cores;
- Assessments from geophysical measurements, either along profiles or along bore holes. In this paper only assessment of refraction seismic measurements are described.

#### 3.1 Some comments on joint spacing

Joint set spacing is the distance between individual joints within a joint set. The terms *joint spacing* and *average joint spacing* are often used in the description and assessments of rock masses.

Where more than one set occurs, this measurement is in the case of surface observations often given as the average of the spacings for these sets. There is often some uncertainty as to how this average value is found. For instance, the average spacing is  $S_a = 0.125$  m for the following 3 joint sets having spacings  $S_1 = 1$  m,  $S_2 = 0.5$  m, and  $S_3 = 0.2$  m, and not  $S_a = 0.85$  m, which initially may seem appropriate. The reason is that the average spacing is found from  $1/S_a = 1/S_1 + 1/S_2 + 1/S_3$  (and not  $S_a = (S_1+S_2+S_3)/3$ )

When logging drill cores the average lengths of core pieces (called *joint intercept*), are seldom true joint set spacings, as joints of different sets are included in the measurement. In addition, random joints, which do not necessarily belong to any joint set, may occur.

As the term "joint spacing" does not clearly indicate what it includes, it is frequently difficult to know whether a joint spacing referred to in the literature represents the true joint set spacing. Thus, there is often much confusion related to the use of joint spacing, which often leads to errors or inaccurate calculations.

#### 3.2 Blocks formed by the joints

The joints delineate blocks. Their dimensions and shapes are determined by the joint set spacings, by the number of joint sets and by the amount of random joints. The block size is an extremely important parameter in rock mass behaviour, see Figure 5.

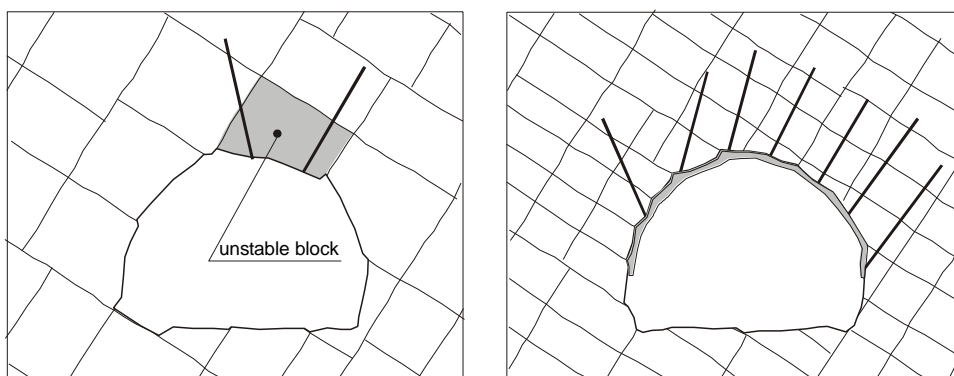

Figure 5 Block size has a main influence on stability in underground openings often being supported by rock bolts (left) and in addition shotcrete (right)



3.2.1 Block types and shapes

The types of blocks delineated by joints have in the literature been characterized in different ways and by different terms. Where relatively regular jointing exists, it may be possible to give adequate characterization of the jointing pattern according to the system presented by Dearman (1991) in Figure 6. In most cases, however, there is no regular jointing pattern; a rough characterization of the blocks is therefore often more practical, for example a division into four main types only, as shown in Figure 7.

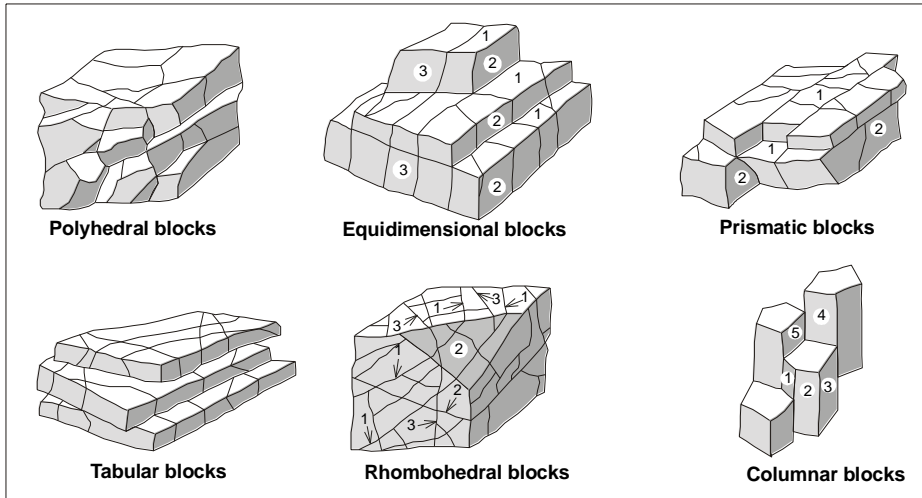

Figure 6 Examples of block shapes or the jointing pattern (from Dearman (1991))

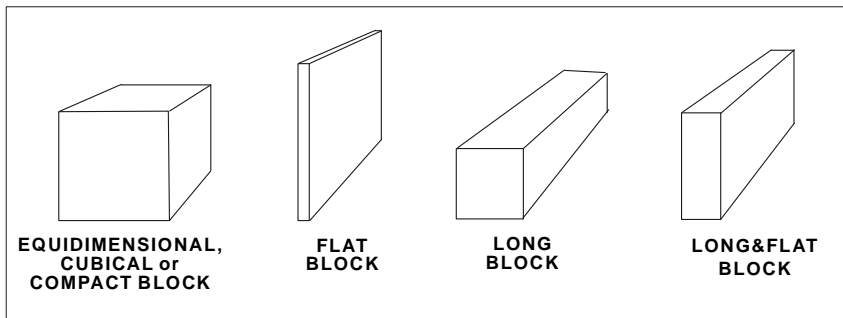

Figure 7 Main types of blocks introduced by Palmström, 1995

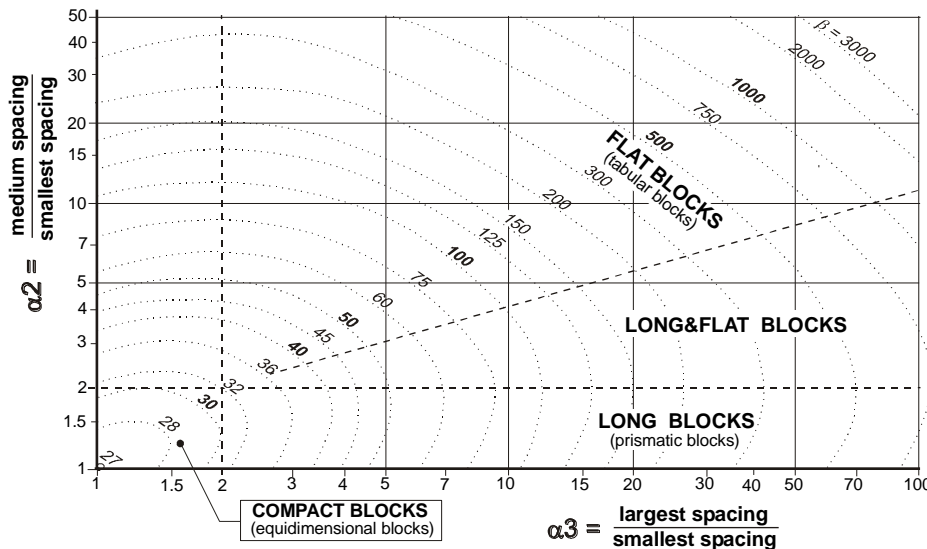

Figure 8 Block types characterized by the block shape factor ( $\beta$ ) found from the ratio between spacings of the joint sets. The data are based on 3 joint sets intersecting at right angles (from Palmström, 1995). Example:  $\beta = 125$  for  $\alpha_2 = 3$  and  $\alpha_3 = 15$  (i.e. long&flat block shape)

The block shape depends mainly on the differences between the joint set spacings. The numerical expression for these can be given by the block shape factor  $\beta$ , which is expressed in eq. (9). For a rock mass with 3 joint sets intersecting at right angles values of  $\beta$  are given Figure 8.

As blocks may be formed by more than six faces or may have irregular shape, it can be difficult to find the value of  $\beta$ . A simplified expression is:

$$\beta = 20 + 7a_3/a_1 \quad \text{eq. (1)}$$

where  $a_3$  is the longest and  $a_1$  the shortest dimension of the block

For very flat to extremely flat blocks eq. (1) has limited accuracy. Where  $\beta$  is not known, it is recommended to use a 'common' value of  $\beta = 36$ .

The block shape influences on the correlation between the block volume and the volumetric joint count as shown in Section 5.5. It is not often used in rock mechanics and rock engineering, though it is a main feature of the jointing, and may be of interest in numerical modelling. It is recommended that block shape is included in descriptions of rock masses.

### 3.3 Measurements of the block volume ( $V_b$ )

#### 3.3.1 *Directly on site or from drill cores*

Where the individual blocks can be observed in a surface, their volumes can be directly measured from relevant dimensions by selecting several representative blocks and measuring their average dimensions. For small blocks or fragments having volumes in  $\text{dm}^3$  size or less, this method of block volume measurement is often beneficial as it is much easier to estimate the block size instead of the many measurements needed to include all joints.

Especially where irregular jointing occurs, it is time-consuming to measure all (random) joints in a joint survey. In such cases, as well as for other jointing patterns, it is often much quicker - and also more accurate - to measure the block volume directly in the field.

The block volume can also be found in drill cores where the fragments are small enough to be measured, for example in crushed rock.

#### 3.3.2 *From joint set spacings*

Where three joint sets occur the block volume is

$$V_b = S_1 \times S_2 \times S_3 \times (\sin\gamma_1 \times \sin\gamma_2 \times \sin\gamma_3) \quad \text{eq. (2)}$$

where  $S_1, S_2, S_3$  are the spacings between the joint sets;

$\gamma_1, \gamma_2, \gamma_3$  are the angle between the joint sets.

Often the joint sets intersect at approximately right angles for which the block volume is

$$V_b = S_1 \times S_2 \times S_3 \quad \text{eq. (3)}$$

#### 3.3.3 *Method where joints do not seem to delimit blocks*

Often, it is not possible to observe the whole individual block in an outcrop or in the surface of an underground opening, especially where less than three joint sets occur. Random joints and/or cracks formed during the excavation process will often result in defined blocks. In such cases a spacing of random joints 5 to 10 times the spacing of the main joint set can often be used to estimate the block volume.

**Example:**

Where only one joint set (S1) can be seen:  $V_b \approx S1 \times 5S1 \times 10S1 = 50 S1^3$

For two joint sets (S1 and S2):  $V_b \approx S1 \times S2 \times 5S1 = 5S1^2 \times S2$

**3.4 Measurements of the volumetric joint count (Jv)**

The volumetric joint count is a measure for the number of joints intersecting a volume of rock mass. It is defined as number of joints per m<sup>3</sup>

**3.4.1 From joint set spacings**

The volumetric joint count (Jv) has been described by Palmström (1982, 1985, 1986) and Sen and Eissa (1991, 1992). It can be measured from the joint set spacings within a volume of rock mass as

$$J_v = \frac{1}{S_1} + \frac{1}{S_2} + \frac{1}{S_3} + \dots \quad \text{eq. (4)}$$

where  $S_1, S_2, S_3$  are the joint set spacings.

Also random joints can be included by assuming a random spacing ( $S_r$ ) for each of these. Experience indicates that this can be set to  $S_r = 5$  m; thus, the volumetric joint count can be generally expressed as

$$J_v = \frac{1}{S_1} + \frac{1}{S_2} + \frac{1}{S_3} + \dots + \frac{N_r}{5} \quad \text{eq. (5)}$$

where  $N_r$  = the number of random joints.

$J_v$  can easily be calculated from common joint observations, since it is based on measurements of joint set spacings or frequencies. In the cases where mostly random or irregular jointing occur,  $J_v$  can be found by counting all the joints observed in an area of known size as described in Section 4.1.

As the volumetric joint count ( $J_v$ ) by definition takes into account in an unambiguous way all the occurring joints in a rock mass, it is often appropriate to use  $J_v$  in the correlation between joint frequency measurements and block volume estimates (Palmström, 1982).

**3.4.2 From 2-D measurements on an area or surface**

The 2-D joint frequency ( $N_a$ ) is the number of joints measured in an area or surface.

**More accurate measurement**

The length of the joints compared to the size of the area will, however, influence on the frequency observed. Thus, for accurate measurements some sort of adjustments should be made to estimate the block volume from this type of measurement. This can be done by adjusting for the lengths of joints shorter than the length of the observation plane, given as

$$N_a = (1/\sqrt{A}) \sum(na_i \times L_i) + N_{a_j} \quad \text{eq. (6)}$$

where  $na_i$  = the joint  $i$  with length  $L_i$  shorter than the length of the observation area,

$N_{a_j}$  = the number of joints longer than the length of the observation area, and

$A$  = the area of the observation surface.

Another method to assess the amount of joints is the weighted jointing method described in Section 4.1

The joint frequency ( $N_a$ ) varies with the orientation of the observation plane and with respect to the attitude of the joints. Recording of  $N_a$  in several surfaces of various orientation gives a more accurate measure of the jointing. Being an average measure,  $N_a$  should be measured in selected areas showing the same type and density of jointing. Thus, a large area should be divided into smaller, representative

areas or structural regions containing similar jointing, and the variation in jointing for the whole area calculated based on these observations.

#### Correlation with $J_v$

The correlation between 2-D measurements of the joint density in a rock surface and the 3-D frequency values (given as  $J_v$ ) can be done using the empirical expression

$$J_v = N_a \times k_a \quad \text{eq. (7)}$$

where  $k_a$  = correlation factor, which varies mainly between 1 and 2.5 with an average value  $k_a = 1.5$ . The highest value is where the observation plane is parallel to the main joint set.

#### 3.4.3 From 1-D measurements along a scanline or drill core

This is a record of the joint frequency along a bore hole or a scanline, given as the number of joints intersecting a certain length. As in other core logging methods, it is important to measure the joints in sections along the line or core which shows similar joint frequency. At the start of the logging it is rational to divide the length into such sections.

The correlation between 1-D joint frequency observations in drill holes (or scanlines) and volumetric 3-D frequency ( $J_v$ ) can be done using an expression similar to eq. (7). The joint frequency, given as the volumetric joint count (number of joints per  $m^3$ , can be expressed as:

$$J_v = N_l \times k_l \quad \text{eq. (8)}$$

where  $k_l$  = correlation factor, which varies between 1.25 and 6, with an average value  $k_l = 2$ .

The correlation between  $J_v$  and  $N_l$  is generally rather inaccurate.

The weighted jointing method described in Section 4.1 gives better assessments than the method described above.

### 3.5 Correlation between $V_b$ and $J_v$

The block volume for three joint sets with intersecting angles  $\gamma_1$ ,  $\gamma_2$  and  $\gamma_3$  is expressed as

$$V_b = \beta \times J_v^{-3} \frac{1}{\sin \gamma_1 \times \sin \gamma_2 \times \sin \gamma_3} \quad \text{eq. (9)}$$

where  $\beta$  = the block shape factor given as  $\beta = \frac{(\alpha_2 + \alpha_2 \times \alpha_3 + \alpha_3)^3}{(\alpha_2 \times \alpha_3)^2}$

(here  $\alpha_2 = S_2/S_1$  and  $\alpha_3 = S_3/S_1$ )

Often the angles between the joints are approximately  $90^\circ$ , therefore, for practical purposes

$$V_b = \beta \times J_v^{-3} \quad \text{eq. (10)}$$

Important here is the block shape factor  $\beta$ , which is included in all equations to estimate the block volume. It is further described in Section 3.2.1.

### 3.6 Measurement of the rock quality designation (RQD)

RQD is by its original definition (Deere, 1966) the length in percent of measured length of the unweathered drill core bits longer than 10 cm.

The RQD is easy and quick to measure, and it is therefore frequently applied in core logging. Often it is the only method used for measuring the jointing density along the core drill hole.

As is known by most people involved in core logging and rock engineering the RQD has several limits. For example,  $RQD = 0$  where the distance (intercept) between the joints is 9 cm or less, while  $RQD = 100$  where the distance is 11 cm or more, see Figure 9.

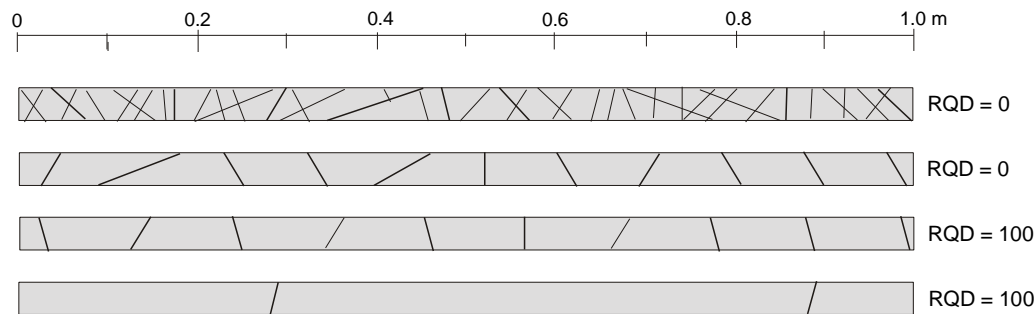

Figure 9 Examples of RQD values for various joint densities along drill cores

This implies that the RQD covers only a limited part of the range of jointing, as shown in Figure 10. This reduces the applicability of RQD in characterizing the jointing density.

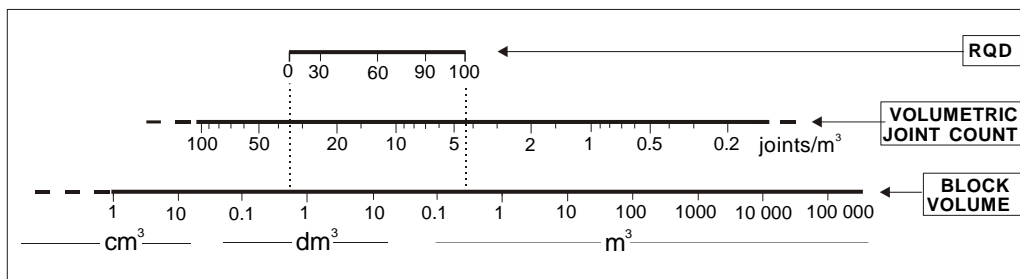

Figure 10 Block size ( $V_b$ ) and volumetric joint count ( $J_v$ ) cover a significantly larger interval of the jointing than the RQD.

It is therefore important more than also other joint density measurements of drill cores than RQD are given in the core log.

Being discontinuous by definition, RQD is not very suitable in calculations. The application of RQD as input in the calculations made may often lead to inaccuracy or errors.

Considering the high costs for core drilling it is remarkable that generally so little attention is directed towards better jointing observations from core logging. For this, the weighted jointing measurement has been can be used, as is described in Section 4.1.

### 3.7 Correlation between RQD and $J_v$

It is not possible to obtain good correlations between RQD and  $J_v$ . Palmström (1982) presented the following simple expression, which is frequently used:

$$RQD = 115 - 3.3 J_v \quad \text{eq. (11)}$$

Here,  $RQD = 0$  for  $J_v > 35$ , and  $RQD = 100$  for  $J_v < 4.5$

As described in the foregoing section, RQD may be rather inaccurate for several occasions. Figure 11 shows that eq. (11) generally gives too low RQD values. The fact that RQD may be zero for values of  $J_v$  as low as  $J_v > 12$ , complicates any correlation of RQD to other joint density measurements.

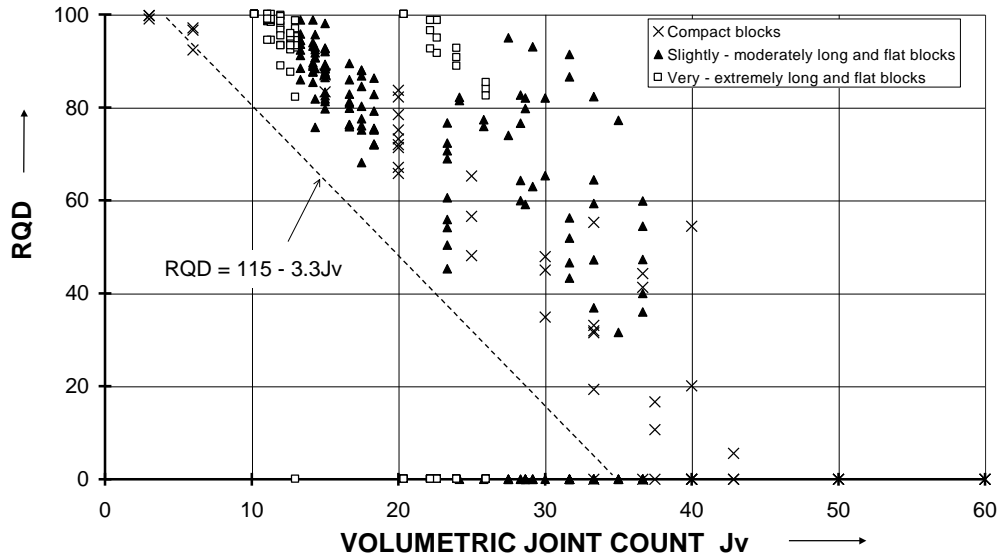

Figure 11 Correlations between RQD and  $J_v$  for various block shapes (from Palmström, 1995)

Especially, where many of the core pieces have lengths around 0.1 m, the correlation above may be inaccurate. However, when RQD is the only joint data available, eq. (11) has been found to be an alternative transition from RQD to  $J_v$ .

**3.8 Block size distribution**

In an actual volume of rock masses the blocks will have various sizes. If the blocks in a rock mass could be sieved, a curve similar to Figure 12 can be found. Within the maximum and minimum block sizes, *the block size range*, it is important that the blocks are characterized with representative volume(s). Ideally, the average  $V_{b50}$  plus  $V_{b25}$  and  $V_{b75}$  should in the best way characterize the block size. In practice, the full range of sizes is seldom known within a certain structural *region* (i.e. rock masses with similar characteristics). Increased amount of observations will, however, give better measurements. During a joint survey the maximum, average and minimum spacing of the joints within each set should be noted, and these values are often used to calculate the block size range.

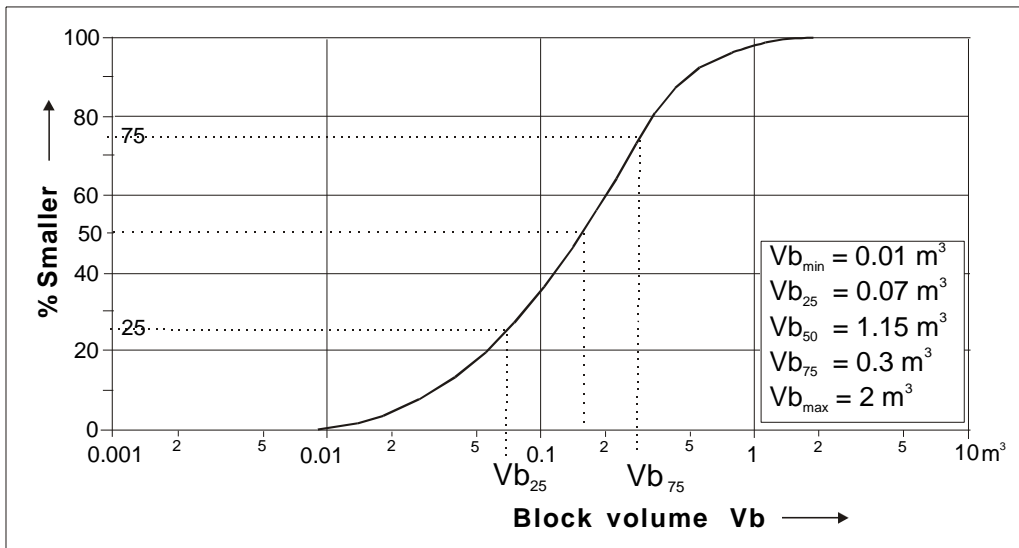

Figure 12 A distribution curve for the blocks in a (large) volume of rock masses

### 3.9 Example, jointing measurements in surfaces

Figure 13 shows the density of joints in 10 x 10 m areas. As one joint set (set 3) is sub-horizontal, only one joint of this set is observed on the horizontal surface, therefore this joint will be observed as a random joint.

From the joint set spacings in Figure 13 the volumetric joint count and the block volume can be found from the expressions in Table 1. As seen, there is a poor correlation between  $J_v$  and  $V_b$  for the horizontal surface as joint set is insufficiently included in the calculations.

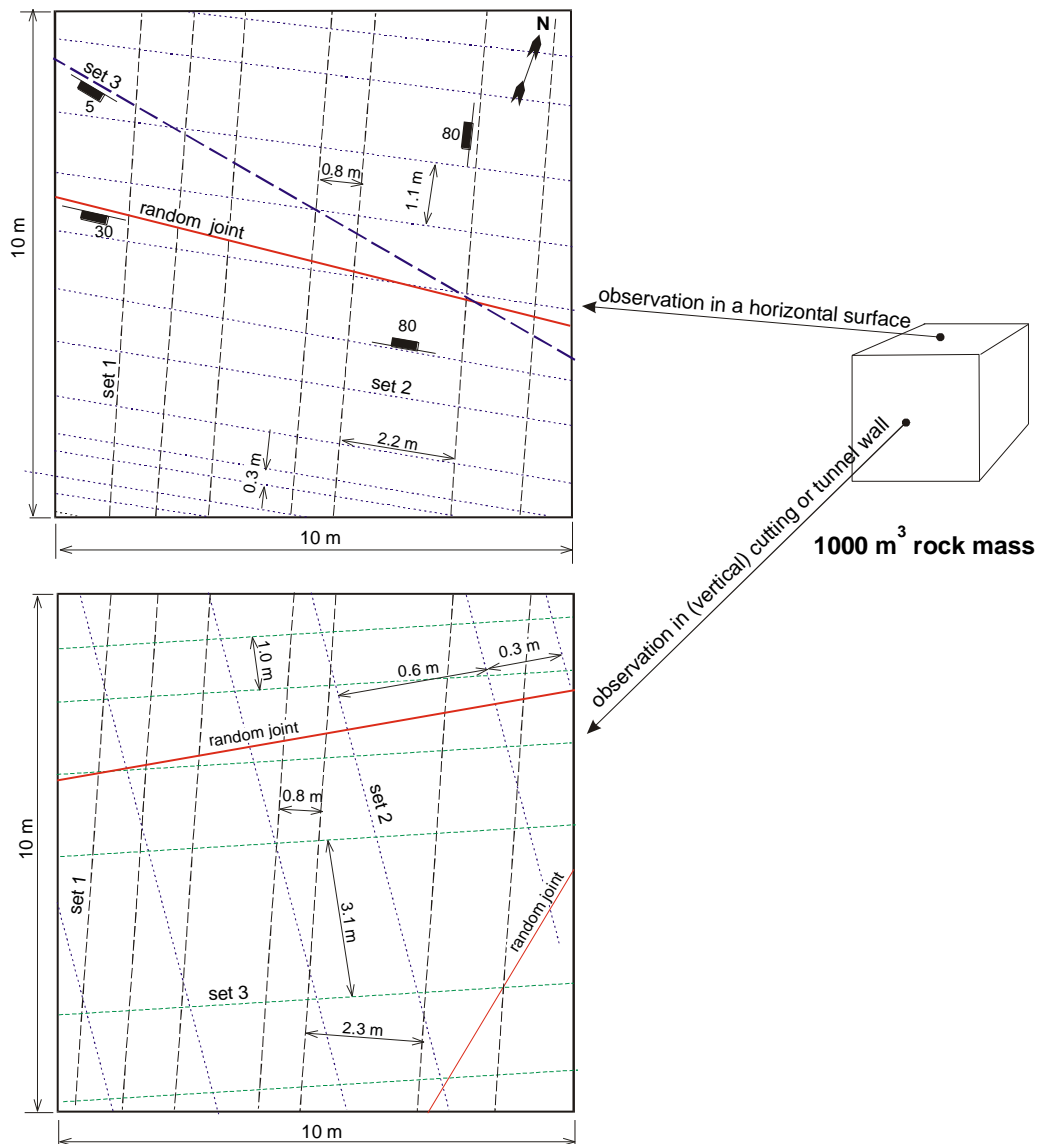

Figure 13 Joint observations in a horizontal and a vertical surface

The theoretically largest block will have dimensions:  $S_1 = 2.3$  m,  $S_2 = 1.1$  m,  $S_3 = 3.1$  m, provided it is not intersected by random joints. Hence the block volume is  $V_b = 2.3 \times 1.1 \times 3.1 = 7.8$  m<sup>3</sup> (as the joints intersect approximately at right angles). With  $\alpha_2 = S_1/S_2 = 2.1$  and  $\alpha_1 = S_3/S_2 = 2.8$ , the block can be described as long&flat with a shape factor  $\beta = 37$  (see Figure 8).

Similarly, the smallest block is  $S_1 = 0.8$  m,  $S_2 = 0.3$  m,  $S_3 = 1.0$  m, giving  $V_b = 0.24$  m<sup>3</sup>. With  $\alpha_2 = 2.7$  and  $\alpha_1 = 3.3$  the block shape factor is  $\beta = 42$ .

Figure 14 shows the 3-D occurrence of the jointing in Figure 13.

Table 1 The measured joint set spacings in Figure 13 and the calculated  $J_v$  and  $V_b$ . Note: To simplify in the example only the small and large spacings have been used.

Measured:	Horizontal surface		Vertical surface	
	min	max	min	max
Spacing in joint set 1	0.8 m	2.2 m	0.8 m	2.3 m
Spacing in joint set 2	0.3 m	1.1 m	0.3 m	0.6 m
Spacing in joint set 3	-	-	1.0 m	3.1 m
Number of random joints <sup>1)</sup>	2 joints (one is from joint set 3)		2 joints	
Calculated:	high	low	high	low
Volumetric joint count ( $J_v$ ) <sup>2)</sup>	5	1.4	6.0	2.4
Block shape factor ( $\beta$ ) <sup>3)</sup>	39	34	43	56
Block volume ( $V_b$ ) <sup>4)</sup>	small	large	small	large
- from joint set spacings <sup>5)</sup>	0.36 m <sup>3</sup>	13.3 m <sup>3</sup>	0.24 m <sup>3</sup>	4.3 m <sup>3</sup>
- from $J_v$ <sup>6)</sup>	0.31 m <sup>3</sup>	12.3 m <sup>3</sup>	0.2 m <sup>3</sup>	4.1 m <sup>3</sup>

<sup>1)</sup> A spacing of 5 m is used in the calculation of  $J_v$  for each of the random joints.

<sup>2)</sup> For the low value of  $J_v$  (largest blocks) random joints have not been included.

<sup>3)</sup> The block shape factor is found from eq. (1)

<sup>4)</sup> The joints intersect approximately at right angles

<sup>5)</sup> The block volume has been found from  $V_b = S_1 \times S_2 \times S_3$

<sup>6)</sup> Eq. (10) has been applied

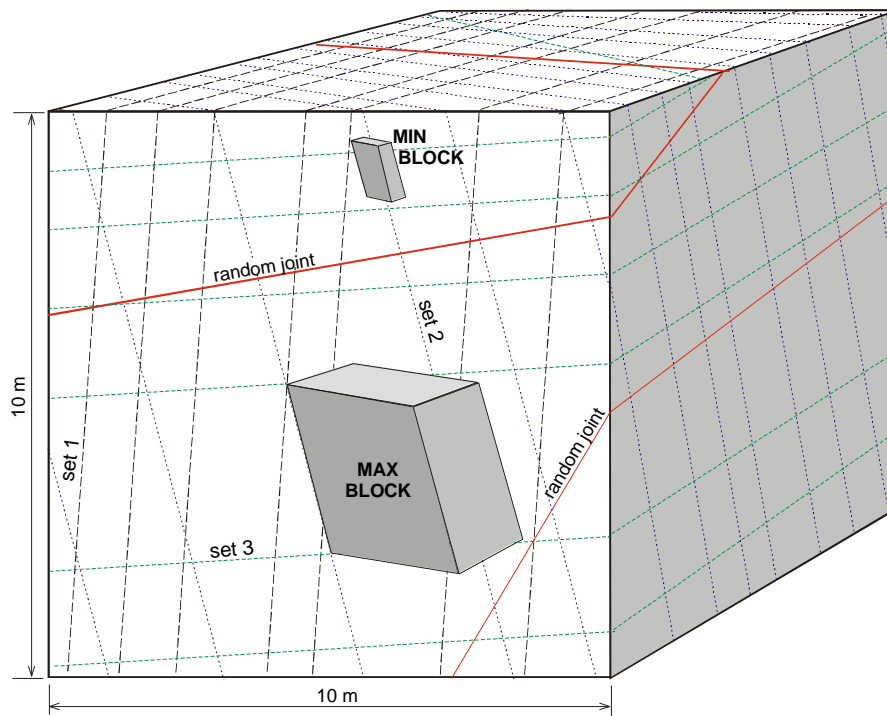

Figure 14 The "solution" of Figure 13. The min. and max. blocks have long&flat block shape

### 3.10 Summing-up measurements of the degree of jointing

The various expressions for combining or converting the various joint density and block size measurements are compiled in Table 2 and Figure 15.



Table 2 Compilation of the various methods to calculate block size and the volumetric joint count

	Distance between joints	Measurement	Calculation of the volumetric joint count (Jv) and/or the block volume (Vb)
3-D	Joint set spacings <sup>1)</sup>	Block volume, Vb	$Vb = S1 \times S2 \times S3 \times (Sin\gamma_1 \times Sin\gamma_2 \times Sin\gamma_3)$ $Vb = \beta \times Jv^{-3}$ *)
	S1, S2, S3, ..	Volumetric joint count, Jv	$Jv = \frac{1}{S1} + \frac{1}{S2} + \frac{1}{S3} + .. + \frac{Nr}{5}$
2-D	Joint set spacings <sup>1)</sup>	Joint density in an area, Na	$Jv \approx ka \times Na$
	S1, S2, S3 ..	Weighted jointing density in an area, wJd	$Jv \approx wJd$
1-D	Joint intercept <sup>2)</sup>	Joint density along a drill core or scanline, NI	$Jv \approx kl \times NI$
	Ji	Rock quality designation, RQD	$Jv \approx 35 - RQD/3.3$
		Weighted jointing density along a line, wJd	$Jv \approx wJd$

<sup>1)</sup> Distance between joints in a joint set  
<sup>2)</sup> Joint intercept is the distance between joints of various joint sets along a drill core. In bore holes this term should be applied instead of the term joint spacing  
 \*)  $\beta$  = block shape factor, a simplified expression is  $\beta = 20 + 7a_3/a_1$  ( $a_3$  and  $a_1$  are the longest and shortest dimension of the block)

kl and ka are factors to convert 1-D and 2-D measurement into volumetric (3-D) measurements

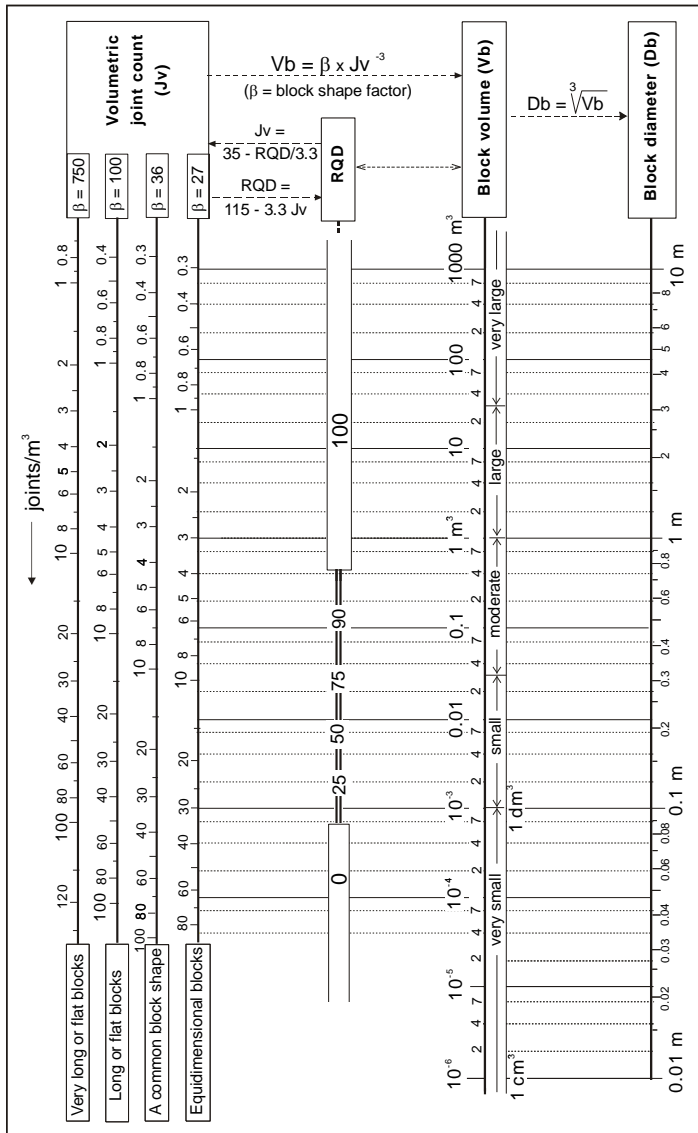

Figure 15 Chart with connections between some joint density measurements. Example: For a common block shape ( $\beta = 36$ ) with  $Jv = 5$  the block volume is  $Vb = 0.3 \text{ m}^3$  and  $RQD \approx 95$ .

## 4. OTHER METHODS TO FIND THE DEGREE OF JOINTING

### 4.1 The weighted jointing density (wJd) method

The weighted joint density method has been developed to achieve better information from bore hole and surface observations.

#### 4.1.1 Principles

In principle, the weighted jointing method is based on the measurement of the angle between each joint and the surface or the bore hole.

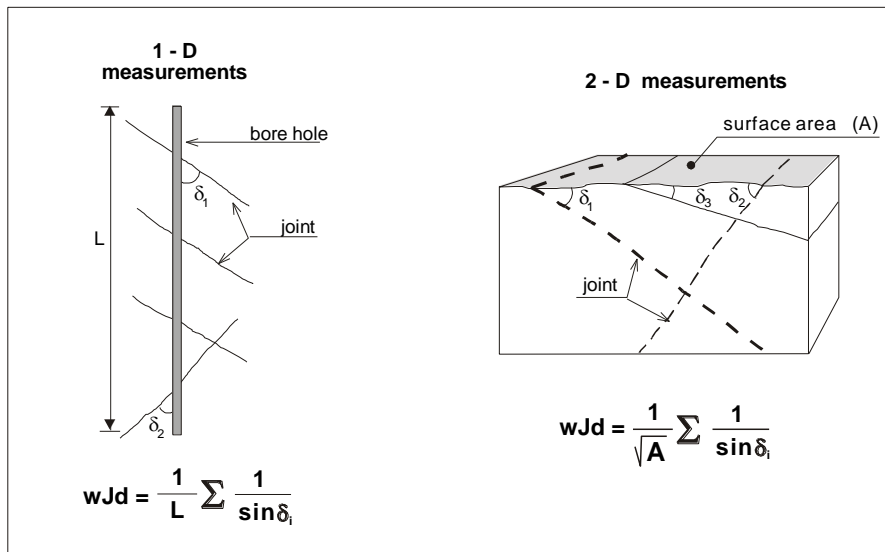

Figure 16 The intersection between joints and a drill core hole (left) and between joints and a surface (right) (from Palmström, 1995).

Table 3 Angle intervals and ratings of the factor  $f_i$

Angle ( $\delta$ ) between joint and surface or bore hole	Rating of the factor $f_i$
$\delta > 60^\circ$	1
$\delta = 31 - 60^\circ$	1.5
$\delta = 16 - 30^\circ$	3.5
$\delta < 16^\circ$	6

To simplify the observations, the angles have been divided into intervals for which average ratings of  $f_i$  have been selected. The definition of wJd is:

$$\text{- for 2-D measurements in rock surfaces: } wJd = \frac{1}{\sqrt{A}} \sum f_i \quad \text{eq. (12)}$$

$$\text{- for 1-D measurements along a drill core: } wJd = \frac{1}{L} \sum f_i \quad \text{eq. (13)}$$

Here  $\delta$  = the intersection angle, i.e. the angle between the observation plane or bore hole and the individual joint:

$A$  = the size of the observed area in  $m^2$ , see Figure 16;

$L$  = the length of the measured section along the drill core (Figure 16);

$f_i$  = a rating factor, its values are shown in Table 3.

Each joint is given a rating  $f_i$  depending on the actual angle interval. It is easy to be familiar with the 5 intervals in Table 3 after some training, as common angles have been selected.

The weighted jointing density method is a relatively quick and simple method. It requires only small additional efforts over currently adopted logging practices. This is to determine the angle interval in Table 3 for each joint. The method reduces the inaccuracy caused by the attitude of joints and thus leads to a better characterization of the rock mass.

The weighted jointing density value is approximately similar to the volumetric joint count ( $wJd \approx Jv$ ).

4.1.2 Examples

**Example 1: 2-D weighted jointing measurements in surfaces of exposed rock**

Two examples of jointing seen on rock surfaces are shown in Figure 17.

The observation area in both examples is  $25 \text{ m}^2$ , and the results from the observations are given in Table 4. In the second example all the joints belong to joint sets. Thus, it is possible to calculate the volumetric joint count ( $Jv = 3.05$ ) from the spacings (which are  $S1 = 0.85 \text{ m}$ ,  $S2 = 1 \text{ m}$ , and  $S3 = 1.1 \text{ m}$ ). As seen in Example 2 the weighted jointing density measurement gives values somewhat higher than the (known) value for the volumetric joint count.

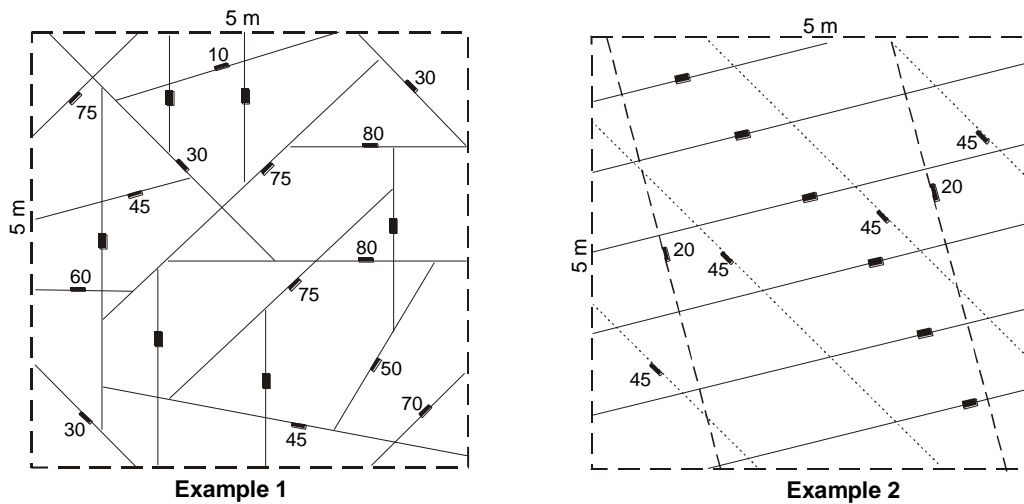

Figure 17 Two examples of jointing on a surface indicating the dip of the joints

Table 4 Calculation of the weighted jointing density from analysis of jointing shown for the surfaces in Figure 17.

Example 1: Observation area $A = 25 \text{ m}^2$				Result $wJd = \frac{Nw}{\sqrt{A}} = 6.9$
Interval	Rating $f_i$	Number of joints (n) within interval	Number of weighted joints $n \times f_i$ within interval	
$> 60^\circ$	1	12	12	
$31 - 60^\circ$	1.5	4	6	
$16 - 30^\circ$	3.5	3	10.5	
$< 16^\circ$	6	1	6	
			$N_w = \sum n \times f_i = 34.5$	

Example 2: Observation area $A = 25 \text{ m}^2$			
Interval	Rating $f_i$	Number of joints (n) within interval	Number of weighted joints $n \times f_i$ within interval
$> 60^\circ$	1	6	6
$31 - 60^\circ$	1.5	4	6
$16 - 30^\circ$	3.5	2	7
$< 16^\circ$	6	0	0
			$N_w = \sum n \times f_i = 19$
Result $wJd = \frac{N_w}{\sqrt{A}} = 3.8$ (known $J_v = 3.05$ )			

### Example 2: 1-D weighted jointing measurements made on drill cores

An example from core logging is shown in Figure 18. The 5 m long part of the core has been divided into the following 3 sections with similar density of joints: 50.0 - 52.17 m, 52.17 - 53.15 m, and 53.15 - 55.0 m. For each section the number of joints within each angle interval has been counted and the results are shown in Table 5.

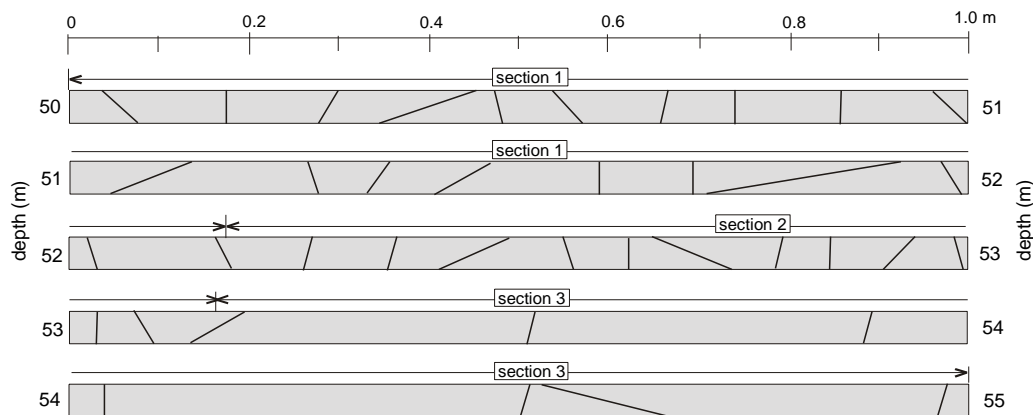

Figure 18 Example of jointing along part of a bore hole

Table 5 Calculation of the weighted joint density from registration of jointing in the bore hole in Figure 18.

Depth 50 - 52.17: Section 1, length $L = 2.17 \text{ m}$			
Interval	Rating $f_i$	Number of joints (n) within interval	Number of weighted joints $n \times f_i$ within interval
$> 60^\circ$	1	11	11
$31 - 60^\circ$	1.5	6	9
$16 - 30^\circ$	3.5	2	7
$< 16^\circ$	6	1	6
			$N_w = \sum n \times f_i = 33$
Result $wJd = \frac{N_w}{L} = 15$			

Depth 52.17 - 53.15: Section 2, length $L = 0.98 \text{ m}$			
Interval	Rating $f_i$	Number of joints (n) within interval	Number of weighted joints $n \times f_i$ within interval
$> 60^\circ$	1	9	9
$31 - 60^\circ$	1.5	3	4.5
$16 - 30^\circ$	3.5	2	7
$< 16^\circ$	6	0	0
			$N_w = \sum n \times f_i = 20.5$
Result $wJd = \frac{N_w}{L} = 20.9$			

Depth 53.15 - 55: Section 3, length L = 1.85 m			
Interval	Rating $f_i$	Number of joints (n) within interval	Number of weighted joints $n \times f_i$ within interval
> 60°	1	5	5
31 - 60°	1.5	0	0
16 - 30°	3.5	1	3.5
< 16°	6	0	0
			$N_w = \sum n \times f_i = 8.5$
			Result $wJd = \frac{N_w}{L} = 4.6$

## 4.2 Joint density assessed from seismic velocities

### 4.2.1 Introduction

The assessment of the density of joints using seismic velocities utilises the propagation of compression seismic refraction waves. The field measurements can be carried out on the ground, in bore holes, or on the seabed. In each case, the refracted head wave travels parallel to the ground surface. The determination of the seismic velocities and the thickness of the various layers is a complex process, and a great deal of practical experience is required of the operator before the results presented in a profile can be regarded as reliable.

The general increase of stresses with depth causes closing of open joints and cracks resulting in increased seismic velocities. Therefore, direct comparisons of velocities in the surface and in the tunnel cannot be made. This reduces the ability of refraction seismic measurements to effectively characterize the degree of jointing in deep tunnels.

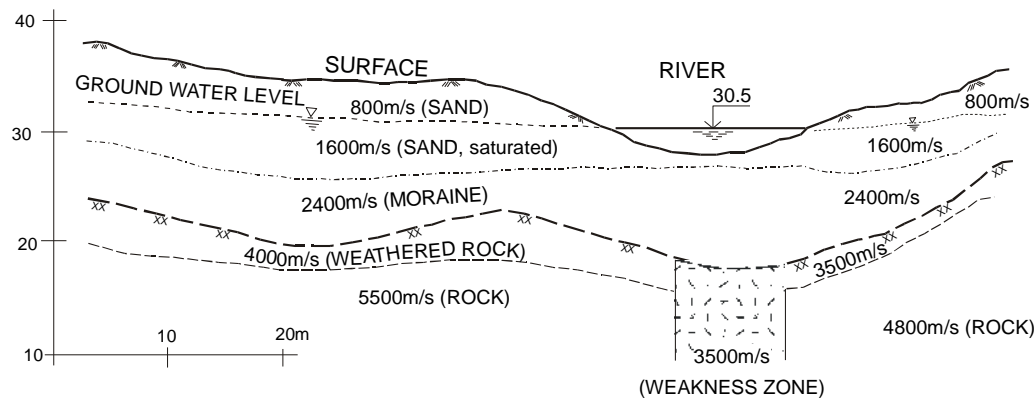

Figure 19 Typical refraction seismic profile in hard, unweathered rocks with interpretations shown in brackets (from Broch, 1988).

There are several factors in the ground that, in a complex way, may influence the propagation of seismic velocities. Sjögren et al. (1979) conclude from their investigations that, in addition to the influence from the inherent rock properties the in situ longitudinal velocities in unweathered rock masses are mainly determined by:

- 1) the density of joints;
- 2) the stresses acting;
- 3) the presence of open joints or joints with filling; and
- 4) the ground water conditions.

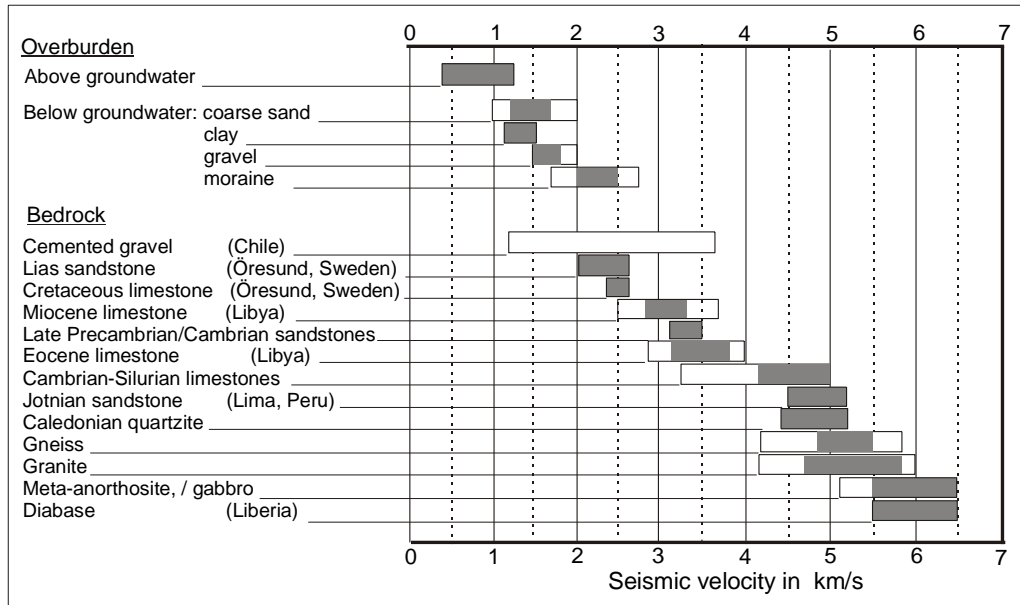

Figure 20 Typical ranges of longitudinal seismic velocities for intact rocks (from Sjögren, 1984)

Correlations between seismic velocities and the degree of jointing can be found from two different approaches: the initial and the refined correlation method.

#### 4.2.2 Alt. 1: The initial correlation method

This method is suitable for cases where no information is available on the jointing versus seismic velocity.

Palmström (1995) has shown two different potential expressions, which may be used to represent the relationship between 1-D jointing (NI) and seismic velocity where no previous correlation exists:

$$NI = V_0^{3.4} \times v^{-2.8} \quad \text{eq. (14)}$$

or

$$NI = 3(V_0/v)^{V_0/2} \quad \text{eq. (15)}$$

where  $V_0$  = the basic velocity of intact rock under the same conditions as in the field.  
 $v$  = the measured in situ seismic velocity (km/s)

Both equations rely on the assessed magnitude of the basic velocity ( $V_0$ ), which represents the site-dependent (in situ) velocity for intact rock. Where  $V_0$  is not known, it is recommended to use the velocity for intact rock under the same conditions as in the field (wet/dry, orientation of anisotropy, stress conditions, etc.) assessed from laboratory testing, from Figure 20 or from tables in textbooks.

Joint openness and possible joint fillings may, however, effect on the accuracy of eqs. (14) and (15) where  $V_0$  is assessed. Therefore, alt. 2 described in the next section gives more accurate results as it includes the site-dependent features.

#### 4.2.3 Alt. 2: Refined correlation method

This method is suitable for cases where at least two correlations between jointing and seismic velocities are already known.

Sjögren et al. (1979) have presented the following expression to calculate the degree of jointing from measured seismic velocities:

$$ks \times NI = 1/v - 1/V_n \quad \text{eq. (16)}$$

where  $V_n$  = the maximum or 'natural' velocity in crack- and joint-free rock (see Figure 21). The 'natural' velocity for some rocks measured in the laboratory are shown in Table 6.

$k_s$  = a constant representing the actual in situ conditions,

$NI$  = the 1-D joint frequency (joints/m) along the drill core or a scanline.

Table 6 Approximate (natural) velocities of fresh rocks without cracks and pores. (from Goodman, 1989)

Rock	$V_n$ (km/s)	Rock	$V_n$ (km/s)
Gabbro	7	Basalt	6.5 – 7
Limestone	6 - 6.5	Dolomite	6.5 – 7
Sandstone and quartzite	6	Granitic rocks	5.5 - 6

The method is based on known data on the jointing collected from field observations and/or logging of cores from bore holes in the seismic profile. Data from at least two different locations are, as mentioned, required to work out a curve similar to that shown in Figure 21.

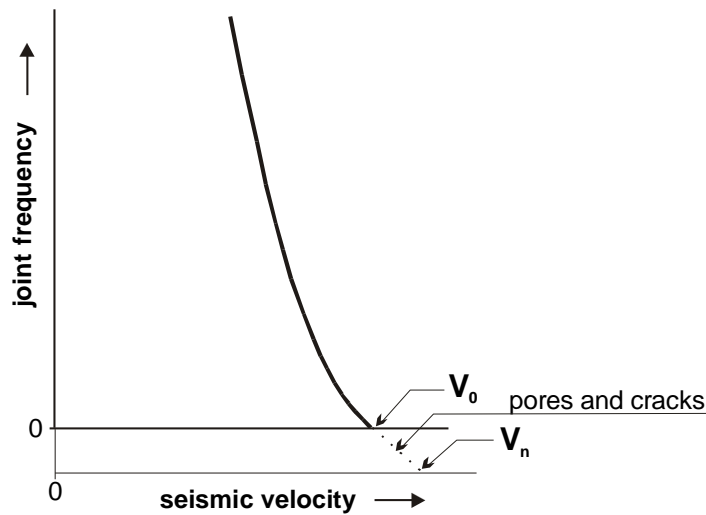

Figure 21 The principle difference of the basic seismic velocity ( $V_0$ ) and the natural or maximum velocity ( $V_n$ )

It is seldom possible to find  $V_n$  at the surface by seismic measurements as the rocks near the surface are seldom free from joints, cracks and pores. Therefore,  $V_n$  can best be found from a calculation procedure such as that described in the following:

The two unknown constants  $k_s$  and  $V_n$  in eq. (16) can be found using two data sets of measured values of  $NI$  and the corresponding  $v$ :

$$V_n = \frac{v_1 \times v_2 (NI_2 - NI_1)}{NI_2 \times v_2 - NI_1 \times v_1} \quad \text{eq. (17)}$$

and

$$k_s = \frac{1}{NI_1} \left( \frac{1}{v_1} - \frac{1}{V_n} \right) \quad \text{eq. (18)}$$

Here  $NI_1, v_1$  and  $NI_2, v_2$  are corresponding values of joint frequency and measured in situ seismic velocity, respectively, for the two pairs of measurements.

When  $k_s$  and  $V_n$  have been found from eqs. (17) and (18), the degree of jointing given as joints/m is found from

$$NI = (V_n - v) / (V_n \times v \times k_s) \quad \text{eq. (19)}$$

From eq. (19) a curve representing the correlation between the measured jointing density and the seismic velocities can be established, see example 2 in Section 4.2.5 and Figure 24.

According to Sjögren et al. (1979) these theoretical calculations of average jointing frequencies have shown a satisfactory agreement with those empirically obtained. The discrepancies between them have been less than 0.5 joints/m. In this way, seismic refraction measurements provide a useful and tool for characterizing the degree of jointing. The volumetric joint count can be calculated from eq. (8).

#### 4.2.4 Applications and limitations using seismic velocities

When the correlation between seismic velocities and the joint density has been established, the joint density along the entire seismic profile can be assessed.

It should, however, be noticed that local differences such as the composition of rock types, mineral content, etc. are averaged, and that the calculations require input of an assumed 'basic velocity' ( $V_0$ ) of the intact (fresh or weathered) rock. The accuracy of  $V_0$  highly influences the quality of the assessments.

As there are several jointing influencing on the seismic velocity, and it is impossible to avoid uncertainties. Knowledge of the geological conditions linked with comprehensive experience in refraction seismic measurements is important in reducing these limitations.

Seismic refraction measurements can not be used to assess the condition of the joint itself (roughness and alteration of the joint surface; filling and size of the joint). Clay and other weak or low friction joint fillings, which may cause instability in a rock mass with few joints, may not in the same amount influence the seismic velocity. On the other hand, one or two open joints that may not have any effect on the stability of an opening, can significantly lower the seismic velocity and give the impression of low quality rock. The possibility that such conditions may exist, must be considered in the interpretation of the seismic refraction results.

#### 4.2.5 Examples

##### **Example 1: On the initial correlation method (alt. 1)**

During the initial planning stage of a project a geological survey was carried out which showed that the bedrocks in the area consisted of fresh dolomite, but no information was available on the jointing. Seismic refraction measurements were performed in an area covered by loose deposits as shown in Figure 22. The rocks in this area were below the ground water table. Based on the velocities of intact rock in Figure 20 the basic velocity of dolomite is estimated as  $V_0 = 5.5$  km/s.

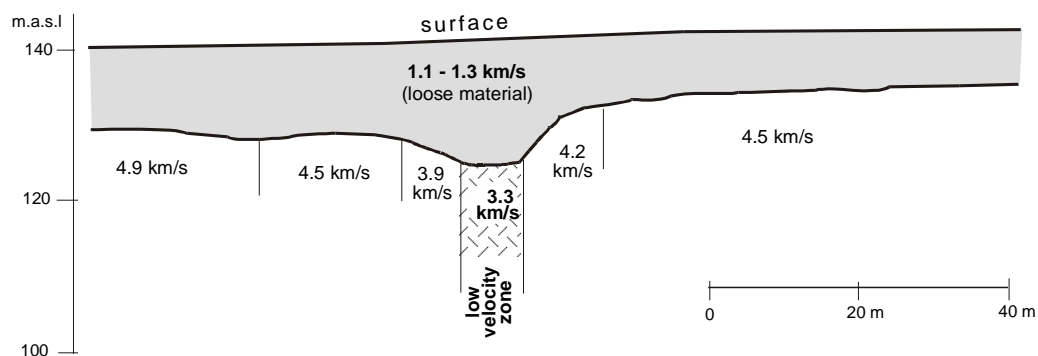

Figure 22 The velocities measured in the refraction seismic profile in dolomite.

The correlations between the degree of jointing (given as joints/m) and seismic velocity from Section 4.2.1 are:

$$\mathbf{i:} \quad Nl = V_0^{3.4} \times v^{-2.8} = 329 v^{-2.8}$$



$$\text{ii: } NI = 3(V_o/v)^{V_o/2} = 326 v^{-2.75}$$

These two expressions for jointing versus velocity have been illustrated in Figure 24 as the curves 'a' and 'b'.

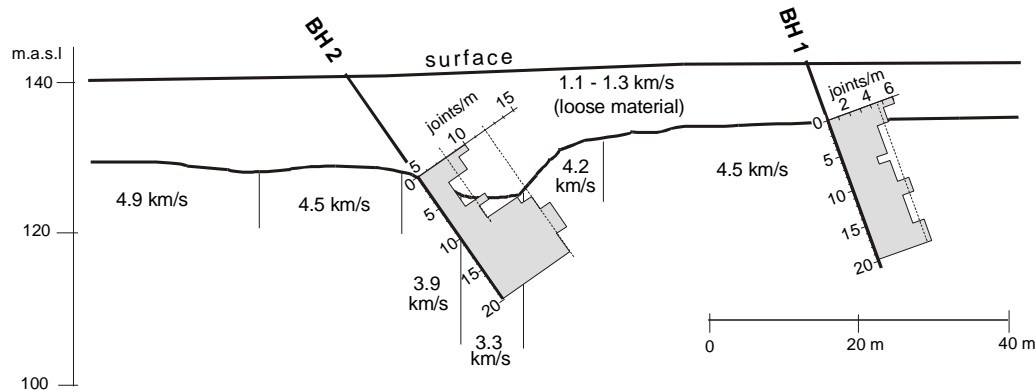

Figure 23 Seismic refraction profile and core drilling results.

### Example 2: On the refined correlation method (alt. 2)

At a later phase in the project two core drillings were carried out in the seismic profile line given in Figure 23, where the joint frequencies are shown.

Three pairs of data from core drilling and seismic measurements are used to establish the relationship between the degree of jointing and the longitudinal seismic velocities. These are shown in Table 7.

Table 7 The data used from drill cores and seismic measurements

Seismic velocity	Joints/m	Bore hole	Comment
1. $v_1 = 4.5$ km/s	$NI_1 = 4.5$	BH 1	Average along the whole bore hole in rock
2. $v_2 = 3.3$ km/s	$NI_2 = 12$	BH 2	Average for 10 - 20 m along the bore hole
3. $v_3 = 3.9$ km/s	$NI_3 = 8$	BH 2	Average for 0 - 10 m along the bore hole

Combining data set 1 and 2 in Table 7 the two unknown constants,  $k_s$  and  $V_n$ , in eqs. (17) and (18) are found as:

$$V_n = \frac{v_1 \times v_2 (NI_2 - NI_1)}{NI_2 \times v_2 - NI_1 \times v_1} = \frac{4.5 \times 3.3 (12 - 4.5)}{12 \times 3.3 - 4.5 \times 4.5} = 5.76 \text{ km/s}$$

and

$$k_s = \frac{1}{NI_1} \left( \frac{1}{v_1} - \frac{1}{V_n} \right) = \frac{1}{4.5} \left( \frac{1}{4.5} - \frac{1}{5.76} \right) = 0.0097$$

The correlation between the degree of jointing given as joints/m and velocity is then

$$NI = (V_n - v)/(V_n \times v \times k_s) = (5.76 - v)/(5.76 \times 0.0097 \times v) = 17.9(5.76 - v)/v$$

This has been illustrated in Figure 24 as curve 'c'. Similarly, combination of data set 2 and 3 in Table 7 gives curve 'd'. As is seen there is good agreement between all curves for joint frequencies higher than 6 joints/m. For the lower frequencies the initial correlation method (curve 'a' and 'b') deviates from the refined correlation method (curve 'c' and 'd'). The latter is considered the most representative.

From the known value of this 1-D joint frequency (NI) the volumetric joint count and the block volume can be calculated applying appropriate correlations.

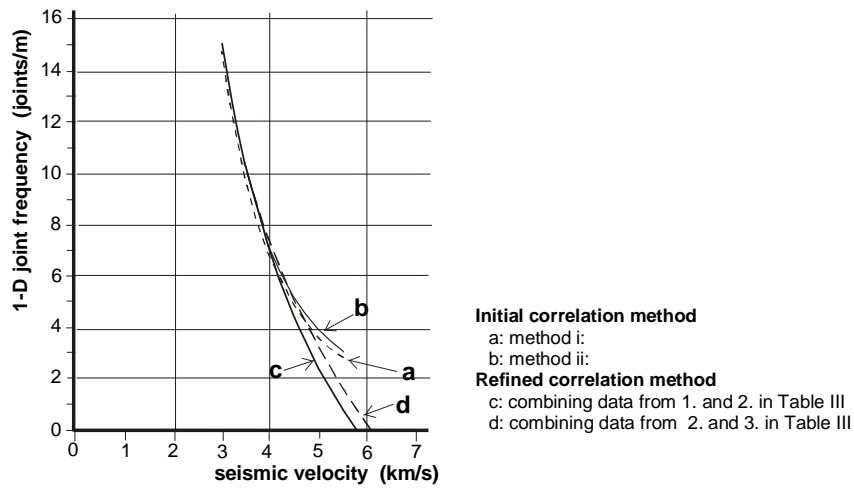

Figure 24 Various correlations between seismic velocities and 1-D joint frequency for the worked examples.

## 5. MEASUREMENTS OF THE JOINT CHARACTERISTICS

The works of Patton (1966) have emphasised the importance of the surface characteristics of joints in determining their shear strength. Of particular importance was Patton's recognition that the shear resistance resulting from asperities on the joint surfaces had to be overcome during deformation either by sliding over or by shearing through.

The main joint characteristics are, see Figure 25:

- joint surface smoothness,
- joint wall waviness or planarity,
- joint size or length,
- joint persistence and termination,
- joint filling or coating, synthesised in joint alteration.

The Q system applies roughness of joints as an input. Originally the system for characterizing joint roughness was developed in South Africa (Piteau, 1970, 1973) and introduced in the United States. It was applied by Cecil (1971).

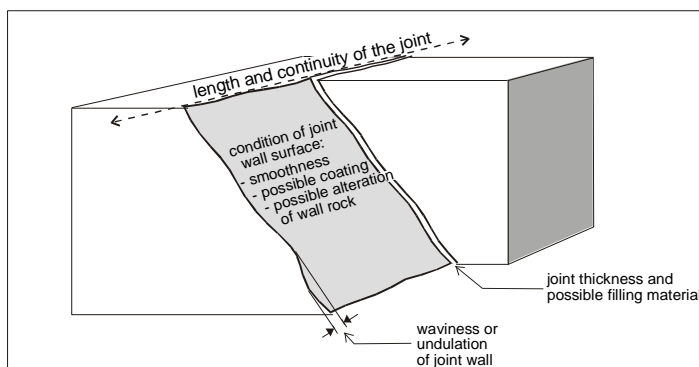

Figure 25 The main joint characteristics

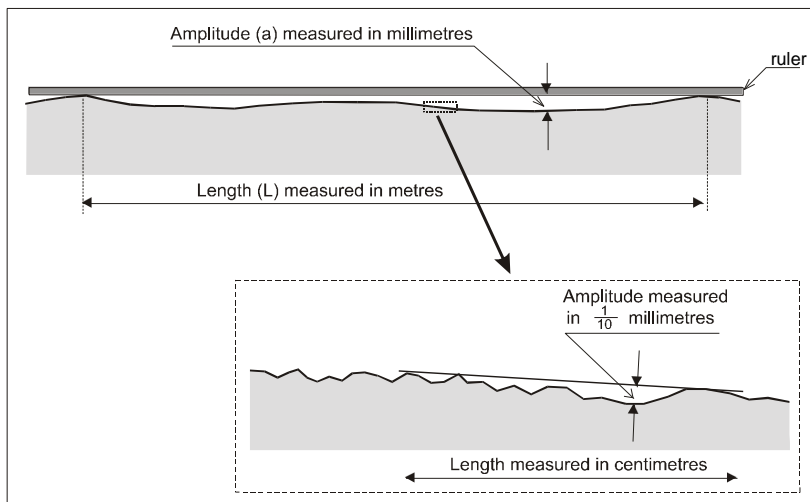

Figure 26 Large scale undulation or waviness of the joint plane (top) and small scale smoothness of the joint surface (bottom). See Figures 27 and 28

The rock mass rating (RMR) classification system makes use of condition of discontinuities, composed of joint length and persistence, joint separation, joint roughness, plus infilling (gouge) and weathering.

### 5.1 Joint roughness

Joint roughness includes the condition of the joint wall surface both for filled and unfilled (clean) joints. A numerical characterization, the joint roughness factor, consists of the large scale undulations of the joint wall, joint waviness or planarity, and the small scale smoothness of the joint surface as shown in

Figure 26. It has been found appropriate to divide the roughness into these two different features, as it is often easier to characterize them separately in the joint survey.

### 5.1.1 Joint planarity or waviness

Waviness of the joint wall appears as undulations from planarity. It is defined by

$$U = \frac{\text{max. amplitude (a}_{\text{max}}) \text{ from planarity}}{\text{length of joint (Lj)}} \quad \text{eq. (20)}$$

The maximum amplitude or offset ( $a_{\text{max}}$ ) can be found using a straight edge which is placed on the joint surface. The length of the edge should be of the same size as the joint, provided that this is practically possible. As the length of the joint seldom can be observed or measured, simplifications in the determination of (U) are often done. A procedure described by Piteau (1970) can be applied with a standard 0.9 m long edge, as shown in Figure 27. For the smallest joints even shorter lengths can be applied. The simplified waviness or undulation is found as

$$u = \frac{\text{measured max. amplitude (a)}}{\text{measured length along joint (L)}} \quad \text{eq. (21)}$$

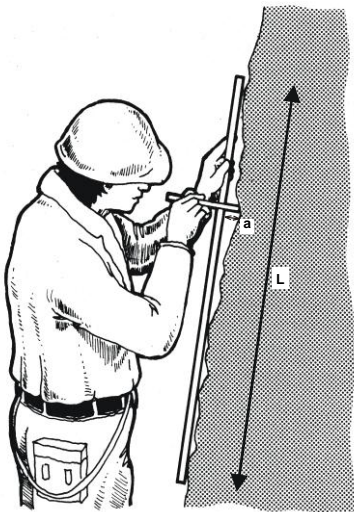

Figure 27 The most accurate, practical measurement of joint wall waviness or undulation (from Milne et al., 1992)

After some training with measurements as shown in Figure 27 the joint waviness can roughly be assessed from simple observations. Where many joint observations are needed, the waviness is often determined by visual observation, because the measurement in Figure 27 is time-consuming.

Table 8 Characterization of the joint planarity expressed as the waviness factor (jw) as suggested by Palmström (1995)

TERM	Undulation ( $u = a/L$ )	Waviness factor (jw)
Interlocking (large scale)		3
Stepped		2.5
Large undulation	$u > 3 \%$	2
Small undulation	$u = 0.3 - 3 \%$	1.5
Planar	$u < 0.3 \%$	1

Waviness can not be observed in drill cores, and must therefore be measured in surface where the joint wall is exposed.

### 5.1.2 Joint smoothness

Surface *smoothness* or unevenness is the nature of the asperities in the joint surface which can be felt by touch. This is an important parameter contributing to the condition of joints. Asperities that occur on the two matching joint surfaces interlock, if they are clean and closed, and inhibit shear movement along joint surfaces. Asperities usually have a wave length and amplitude measured in tenth of millimetres (see Figure 26) and are readily apparent on a core-sized exposure of a discontinuity. The applicable descriptive terms are defined in Table 9.

Most often the smoothness is determined from touching the surface of the joint using the description in Table 9 to determine the rating of *js*. A more accurate method is shown in Figure 28, especially to find the joint roughness coefficient (JRC) as defined by Barton (1976), see also Figure 30.

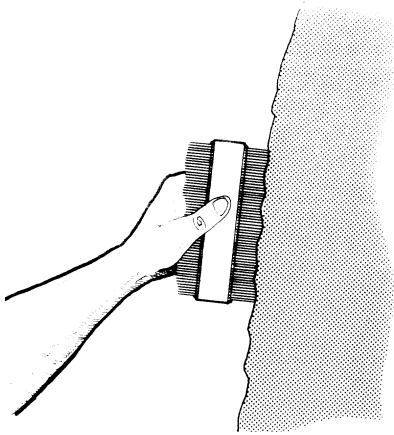

Figure 28 The practical measurement of joint surface smoothness (from Milne et al., 1992)

Table 9 Characterization of the smoothness factor (*js*) as suggested by Palmström, 1995

TERM	DESCRIPTION	Smoothness factor, <i>js</i>
Very rough	Near vertical steps and ridges occur with interlocking effect on the joint surface.	3
Rough	Some ridge and side-angle steps are evident; asperities are clearly visible; discontinuity surface feels very abrasive. (like sandpaper grade approx. < 30)	2
Slightly rough	Asperities on the discontinuity surfaces are distinguishable and can be felt. (like sandpaper grade approx. 30 - 300).	1.5
Smooth	Surface appear smooth and feels so to the touch. (smoother than sandpaper grade approx. 300).	1
Polished	Visual evidence of polishing exists, or very smooth surface as is often seen in coatings of chlorite and specially talc.	0.75
Slickensided	Polished and often striated surface that results from friction along a fault surface or other movement surface.	0.6 - 1.5

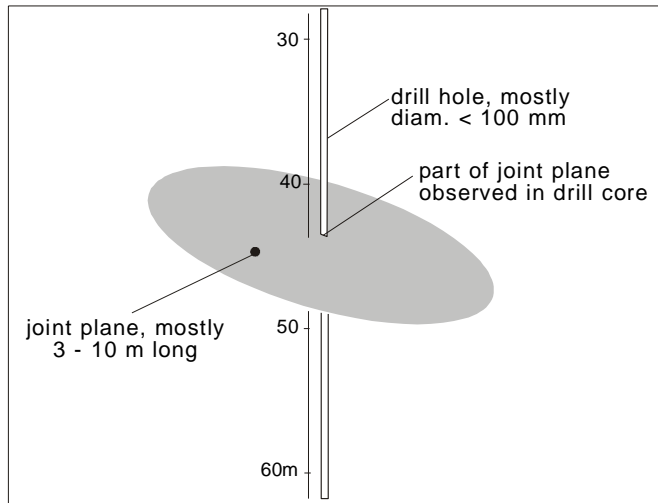

Figure 29 Only a very small portion of the joint can be observed in drill cores, therefore they only give limited information on the joint characteristics, (only indication of their smoothness)

A joint roughness factor is found from  $jR = j_s \times j_w$ , or it can be determined from Table 10. As shown, the ratings of these parameters are the same as used for  $J_r$  in the Q system. For joints with filling thick enough to avoid contact of the two joint walls, any shear movement will be restricted to the filling, and the joint roughness will then have minor or no importance. In such cases it is often difficult or impossible to measure the smoothness and often also the waviness. Therefore, the roughness factor is has unit value.

Table 10 Combination of the joint waviness and joint smoothness factor into the joint roughness factor ( $jR$ ), which is similar to  $J_r$  in the Q-system

(The ratings in <i>bold italic</i> are used for $J_r$ in the Q system)		Large scale waviness of joint plane				
		Planar	Slightly undulating	Undulating	Strongly undulating	Stepped or interlocking
Small scale smoothness of joint surface	Very rough	2	3	4	6	6
	Rough	<b>1.5</b>	2	<b>3</b>	4.5	6
	Smooth	<b>1</b>	1.5	<b>2</b>	3	4
	Polished or slickensided <sup>*)</sup>	<b>0.5</b>	1	<b>1.5</b>	2	3
	For filled joints $jR = 1$ For irregular joints a rating of $jR = 6$ is suggested					
*) For slickensided surfaces the ratings apply to possible movement along the lineations						

In practice, the smoothness is measured by moving the hand along the joint surface, and waviness by simple observation after some training.

Barton (1976) introduced the joint roughness coefficient (JRC), see Figure 30, which gives a picture of the smoothness and waviness (planarity) along 0.1 m length of the joint.

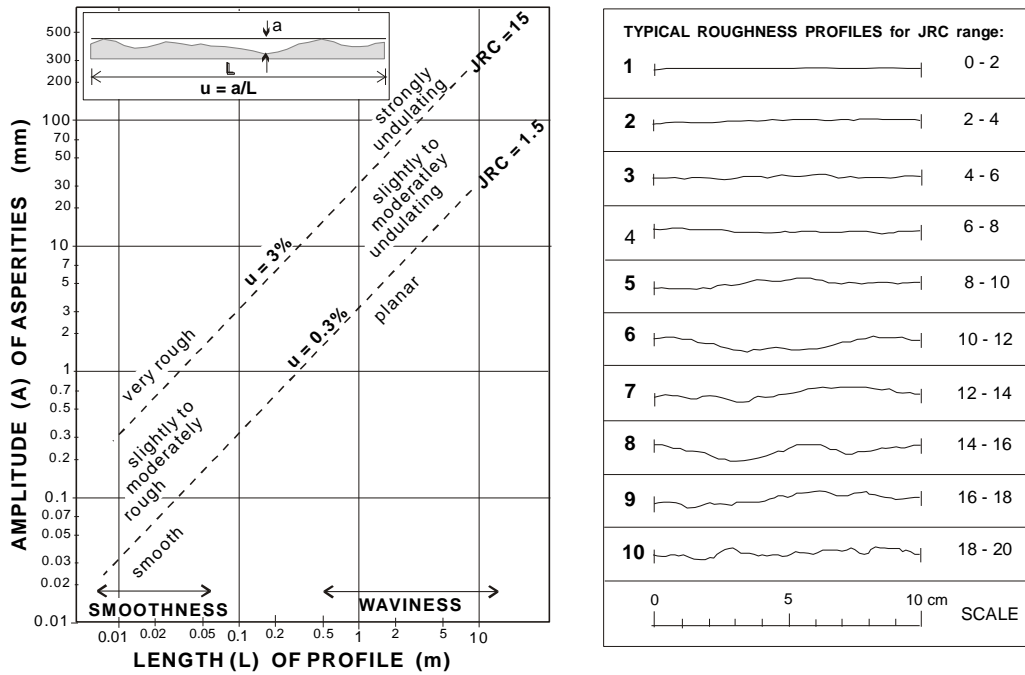

Figure 30 Right: The JRC (Joint Roughness Coefficient) introduced by Barton (1976). and the joint waviness and smoothness (left)

## 5.2 The joint condition or alteration

This factor represents both the strength of the joint wall and the effect of filling and coating materials. The strength of the surface of a joint is a very important component of shear strength and deformability where the surfaces are in direct rock to rock contact as in the case of unfilled (clean and coated) joints. The strength of the joint surface is determined by the following:

- the condition of the surface in clean joints,
- the type of coating on the surface in closed joints,
- the type, form and thickness of filling in joints with separation.

The main types of filling materials and their possible behaviour are shown in Table 11.

Table 11 Main types of coating and filling materials and their properties, (mainly based on Brekke and Howard, 1972)

TYPE OF FILLING	PROPERTIES
Chlorite, talc, graphite	Very low friction materials, in particular when wet.
Inactive clay materials	Weak, cohesion materials with low friction properties.
Swelling clay	Exhibits a very low friction and loss of strength together with high swelling pressure.
Calcite	May dissolve, particularly when being porous or flaky.
Gypsum	May dissolve.
Sandy or silty materials	Cohesionless, friction materials.
Epidote, quartz	May cause healing or welding of the joint.

When *weathering* or *alteration* has taken place in the rock, it can be more pronounced along the joint wall than in the block. This results in a wall strength that can be considerably lower than in the fresher rock found in the interior of the rock blocks. The state of weathering or alteration of the joint surface is therefore essential in the characterization of the joint condition.

The numerical characterization of the joint alteration for fresh joints as well as coated and filled joints is shown in Table 12.

Table 12 The implementation of joint condition and filling, expressed as the joint alteration factor  $jA$  applied in the RMI system (The ratings in ***bold italic*** are used for  $J_a$  in the Q system )

Contact between joint walls			$jA$	
CLEAN JOINTS	Healed or welded joints	filling of quartz, epidote, etc.	<b><i>0.75</i></b>	
	Fresh joint walls	no coating or filling, except from staining (rust)	<b><i>1</i></b>	
	Altered joint walls	one grade higher alteration than the rock	2	
		two grades higher alteration than the rock	4	
COATING or THIN FILLING	Frictional materials	sand, silt calcite, etc. without content of clay	<b><i>3</i></b>	
	Cohesive materials	clay, chlorite, talc, etc.	<b><i>4</i></b>	
Partly or no wall contact			$jA$ for thin filling ( $< ca. 5 mm$ )	$jA$ for thick filling
THICK FILLING	Frictional materials	sand, silt calcite, etc. (non-softening)	<b><i>4</i></b>	<b><i>8</i></b>
	Hard, cohesive materials	clay, chlorite, talc, etc.	<b><i>6</i></b>	<b><i>5 - 10</i></b>
	Soft, cohesive materials	clay, chlorite, talc, etc.	<b><i>8</i></b>	<b><i>12</i></b>
	Swelling clay materials	material exhibits swelling properties	<b><i>8 - 12</i></b>	<b><i>13 - 20</i></b>

### 5.3 Joint size, termination and persistence

The size and continuity of the joints often have great influence on the properties of rock masses, in particular the difference in importance between partings and normal joints upon rock mass behaviour.

The joint length can be crudely quantified by observing the discontinuity trace lengths on surface exposures. But it is often difficult to quantify anything but crude terms. Frequently, rock exposures are small compared to the length of persistent discontinuities, and the real persistence can only be guessed. The size or the length of the joint is often a function of the thickness or separation of the joint, and can sometimes be evaluated from this feature.

As the exact length of a joint seldom can be found, the most important task is to estimate the size range of the joint. Often it is no problem to observe the difference between partings and medium or larger sized joints during field observations.

Joint continuity is divided into two main groups:

- continuous or persistent joints that terminate against other joints
- discontinuous joints that terminate in massive rock.

Table 13 shows the division of joint size as used by Palmström 1995, together with the ratings applied as input to the rock mass index (RMI) characterization system

Table 13 The joint size and continuity factor ( $jL$ ) with ratings, as applied in the RMI characterization.

Length	Term	Type	Rating of $jL$	
			continuous (persistent) joints	discontinuous joints
$< 1 m$	very short	bedding/foliation partings	3	6
0.1 - 1.0 m	short/small	joint	2	4
1 - 10 m	medium		1	2
10 - 30 m	long/large		0.75	1.5
$> 30 m$	very long/large	filled joint or seam <sup>*)</sup>	0.5	1

<sup>\*)</sup> Often a singularity, and should in these cases be treated separately.

### 5.4 The joint condition factor ( $jC$ )

In the rock mass index (RMI) characterization system the joint roughness, joint alteration and joint size has been combined to express a joint condition factor



$$jC = \frac{jR \times jL}{jA} \quad \text{eq. (22)}$$

The strength of the rock in which the discontinuities occur, has a direct bearing on the strength characteristics of the discontinuities, particularly where the walls are in direct rock to rock contact as in the case of unfilled joints (ISRM, 1978). The nature of *asperities*, particularly those of roughness and hardness, are likely to be dependent on the mineralogical and lithological make-up of the rock. Mineral *coatings* will affect the shear strength of discontinuities to a marked degree if the walls are planar and smooth as stated by Piteau (1970).

The distance between the two matching joint walls controls the extent to which these can interlock. In the absence of interlocking, the shear strength of the joint is that of the filling material. As separation decreases, the asperities of the rock wall gradually become more interlocked, and both the filling and the rock material contribute to the shear strength. According to Barton et al. (1974) the function  $\text{Tan}^{-1}(jR/jA)$  in the Q system is a fair approximation to the friction angle of the joint. This equals to the ratio  $jR/jA$  in the rock mass index (RMi) characterization system.

## 6. UNCERTAINTIES AND ERRORS IN JOINTING MEASUREMENTS

### 6.1 Introduction

The following two expressions need an explanation:

*Uncertainty* or lack of absolute sureness in geology means that the observations, measurements, calculations and evaluations made are not reliable. The consequences are that the use of geological data often may involve some kind of guesswork.

*Error* is defined as the difference between an observed or calculated value and a true value;

Einstein and Baecher (1982) have defined three main sources for uncertainties and errors in engineering geology and rock mechanics:

1. Innate, spatial variability of geological formations, where wrongly made interpretations of geological setting may be a significant consequence.
2. Errors introduced in measuring and estimating engineering properties, often related to sampling and measurements.
3. Inaccuracies caused by modelling physical behaviour, including incorrect type of calculations or models.

Of these, item 2 is relevant in jointing measurements and is therefore discussed in the following section.

### 6.2 Measurement errors

A complete description of joints is difficult because of their three-dimensional nature and their limited exposure in outcrops, borings or tunnels. According to Dershowitz and Einstein (1988), the ideal characterization of jointing would involve the specific description of each joint in the rock mass, exactly defining its position and geometric and mechanical properties. This is not possible for a number of reasons, among others:

1. The visible parts of joints are limited, for instance to joint traces only, and thus prevent complete observation.
2. Joints at a distance from the exposed rock surfaces cannot be directly observed.
3. Direct (visual or contact measurements) and indirect (geophysical) observations have limited accuracy.

For these reasons joints in the rock mass are usually described as an assemblage rather than individually. The assemblage has a stochastic character in that joint characteristics vary in space.

Joints show great variation in properties and some of the most significant errors due to selection of joints to be characterized are according to Robertson (1970):

- Small joints are often disregarded.
- Very large fracture surfaces may be measured more than once.
- Joints almost parallel to the foliation or bedding may be overlooked.

Ewan et al. (1983) report from an interesting investigation carried out in the Kielder aqueduct tunnels, UK, to see the reproducibility of joint spacing and orientation measurements:

Three 10 m long scanlines were set up in each of the three rock types: sandstone, mudstone and limestone. On each scanline 6 experienced observers recorded the position and the orientation of each joint (less than 15 m long), see Figure 31.

### DIFFERENT PERSONS MAPPING JOINTS DIFFERENTLY

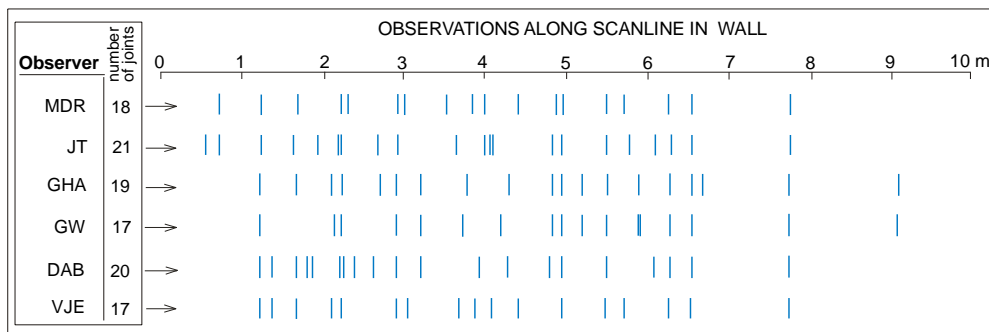

Figure 31 Position of joints recorded by different observers on one of the scanlines (modified from Ewan et al., 1983)

By comparing the results of the measurements carried out by the 6 persons it was found that:

- The variation in the number of joints recorded by different observers along any one scanline varied considerably. The ratio between the highest and lowest number of joints recorded was as high as 3.8, but with a mean of about 2.
- The average maximum error in measurement of joint orientation was  $\pm 10^\circ$  for dip direction and  $\pm 5^\circ$  for dip angle.

The fact that different observers did not identify joints at the same position underlines the difficulty of interpretation of joints and jointing.

Another serious error in mapping of joints may come in outcrops exposed to the effect of weathering. Extrapolating data from weathered outcrops should, therefore, be done carefully.

Another significant measurement error is associated with the angular measurement of dip and strike. This error varies with the inclination of the joint, increasing as the joint tends to be horizontal. For flat-lying structures of the order of  $5 - 10^\circ$ , where the horizontal line of projection is extremely limited, such as for joint in a tunnel wall, Robertson (1970) has experienced that the measured strike may vary as much as  $\pm 20^\circ$ . For attitude measurements of planar features, Friedman (1964) estimates accuracy of  $\pm 1^\circ$  for dips greater than  $70^\circ$  and  $\pm 3^\circ$  for inclinations of  $30 - 70^\circ$ . The latter estimates may apply to mapping of large surface outcrops, but not to observations of limited dimensions such as in tunnels.

Piteau (1973) mentioned that since many joints are highly undulating and the scale of the tunnel or observation area often is much smaller than that of the joint, measurements of both strike and dip may be extremely erroneous, depending where the joint is measured.

In addition to the errors mentioned above, significant errors may be introduced by the characterizations caused by poor definitions and/or personal interpretations.

Although weakness zones basically can be said to be composed of mainly rock(s) in addition to joints and seams with or without filling, a great variety exist. Weathering, hydrothermal activity and alteration are features that may have had a significant impact on the composition and properties of a zone. Thus, many zones show very complicated structure, see Figure 32. This, of course, may introduce errors to descriptions and measurements.

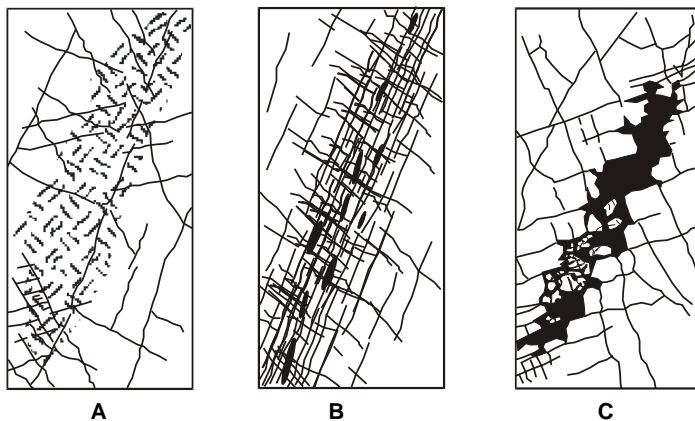

Figure 32 Measurement or description of weakness zones can be very difficult because they often show frequent variations in their composition and structure. It is very difficult from a bore hole log to characterize the structure and composition of a weakness zone (from ISRM, 1978)

### 6.3 Errors and inaccuracies in core drilling and logging

When making drill holes, the angle between the hole and the main joint set may strongly influence on the number of joints encountered in the drill cores, see Figure 33. The use of the weighted jointing method will reduce this type of error.

Careless core drilling will easily introduce additional breaks in the core. It will also cause that joint filling material is washed out and reduce possible core recovery in poor rock mass conditions. This will limit possible information on the rock mass composition.

An important source of error is that breaks created during drilling are counted or measured as joints in the core log, which will show a higher degree of jointing than the real. It is therefore important to study the ends of each core bit during the core logging to find whether they are real joints or are breaks created during the drilling process.

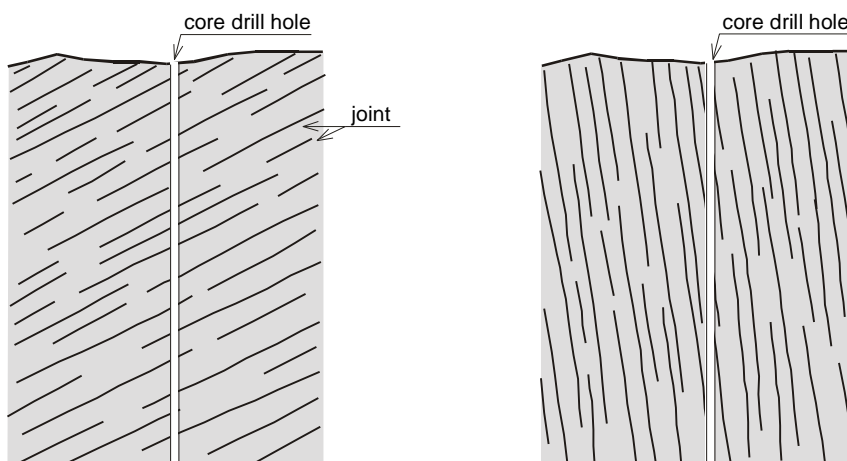

Figure 33 The angle between the joints and the drill core may strongly influence on the length of the core pieces.

The angle between the main joint set and the bore hole may strongly influence the density of joints along the drill core. The weighted jointing density measurement reduces this source of error.

Another frequent error is that the joint intercept (distance between joints in a drill core) is described and calculated as being spacings between joints in a joint set, see Section 3.1.

Most core logging is performed by measuring the joints along each metre of the core. If there are alternating sections with lower and higher densities of joints, this type of logging will easily introduce measurement errors, as shown in Figures 34 and 35.

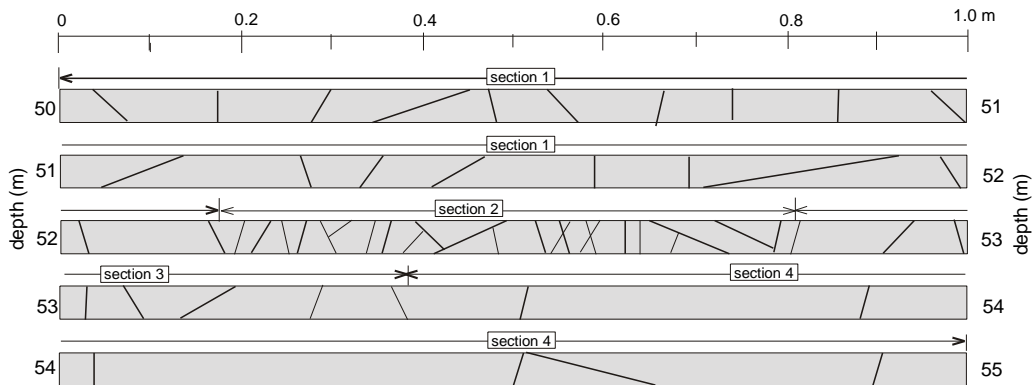

Figure 34 It is important to divide the cores onto intervals of similar jointing and log each of them separately

Table 14 The measured RQD values in Figure 34.

MEASUREMENT IN SECTIONS				MEASUREMENT EVERY METRE			
Section	Length	Core pieces > 10 cm	RQD	Interval	Length	Core pieces > 10 cm	RQD
1	2.17	1.62	75	50 - 51	1.0	0.66	66
2	0.63	0	0	51 - 52	1.0	0.82	82
3	0.56	0.23	41	52 - 53	1.0	0.26	26
4	1.63	1.55	95	53 - 54	1.0	0.75	75
				54 - 55	1.0	0.92	92

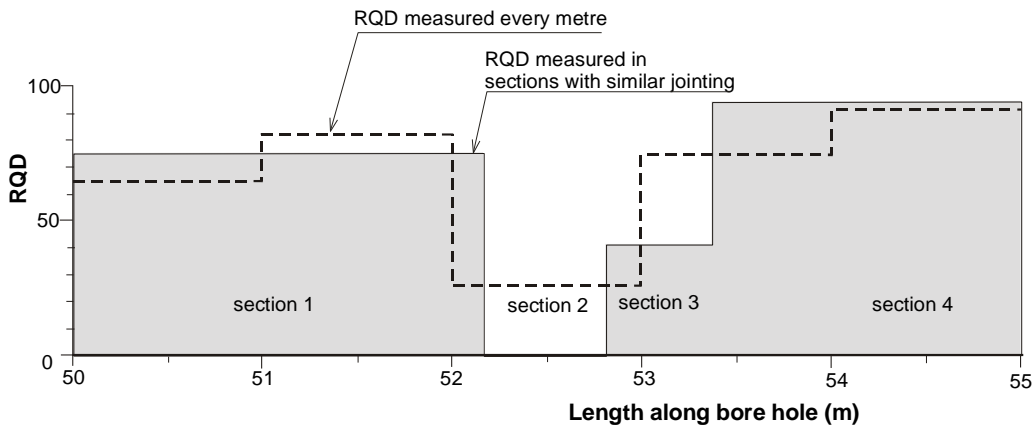

Figure 35 The graphic presentation of the jointing shown in Figure 34 and Table 14. RQD measured in sections compared to RQD measured every metre

As presented in Figure 35 the measurement of joint density every meter levels out the variation in jointing along the core.

**6.4 Summing-up uncertainties and errors**

"I am more and more amazed about the blind optimism with which the younger generation invades this field, without paying attention to the inevitable uncertainties in the data on which their theoretical reasoning is based and without making serious attempts to evaluate the resulting errors." Karl Terzaghi (in his latest years)

From the foregoing it has been found that the following features may cause uncertainties and errors and hence reduced quality of engineering and rock mechanical calculations:

- The spatial occurrence, variations and large volume of the material (i.e. rock mass) involved in a rock construction, which complicate the collection of the jointing parameters.
- How the investigations are performed.
- Uncertainties connected to the joints measured, as only a portion of the joints may be exposed, which are considered to be representative of the joints within the entire rock mass.
- Outcrops or surfaces, where they occur, may not be representative due to weathering.
- In excavated surfaces and in drill cores it may be difficult to distinguish between natural and artificially induced discontinuities.
- Limitations in drill core logging: artificial breaks are included, and information relating to the waviness and the continuity of joints is minimal. In addition soft gouge is often lost during core recovery.
- The way the description is performed or the quality of the characterization made of the various parameters in rock masses. As most of the input parameters in rock engineering and rock mechanics are found from observations, additional errors may be introduced from poorly defined descriptions.

All these aspects have important consequences in the application of geo-data in rock mechanics, rock engineering, and construction design. The main conclusions are therefore:

1. Although extensive field investigation and good quality descriptions will enable the engineering geologist to predict the behaviour of a tunnel more accurately, it cannot remove the risk of encountering unexpected features.
2. A good quality characterization of the rock mass will, however, in all cases, except for wrong or incorrect geological interpretations, improve the quality of the geological input data to be applied in evaluation, assessment or calculations and hence lead to better designs.
3. The methods, effort and costs of collecting geo-data should be balanced against the probable uncertainties and errors.

Table 15 Information on characteristic jointing parameters obtained from various types of data collection (based on Palmström, 1995).

JOINTING FEATURE	DATA COLLECTED FROM				
	Logging of drill cores	Observations in:			Assessment from refraction seismic velocities
		adits	under-ground openings	rock outcrops (except highly weathered rocks)	
Block size or volumetric joint count	(x)	x	x	x	(x)
Joint set spacing or frequency	-	x	x	x	-
Joint intercept	x				
Joint length	-	(x)	(x) / x	x / (x)	-
Joint orientation	-	x	x	x	-
Joint waviness	-	x	x	x	-
Joint smoothness	x	x	x	x / (x)	-
Joint filling or coating	(x) / x	x	x	(x) / -	-
here is:	x	parameter can preferably be measured			
	(x)	parameter can only occasionally be measured, or measurement may be inaccurate			
	-	not possible to measure the parameter or task			

## 7. REFERENCES

- Barton, N., Lien, R. and Lunde, J. (1974): Engineering classification of rock masses for the design of rock support. *Rock Mechanics* 6, 1974, pp. 189-236.
- Barton N. (1976): The shear strength of rock and rock joints. *Int. J. Rock Mech. Min. Sci. & Geomech. Abstr.*, Vol. 13, No. 9, pp. 255-279.
- Baecher G.S. and Lanney N.A. (1978): Trace length biases in joint surveys. *19th US Symp. on Rock Mechanics*, Stateline, Nevada, pp. 56-65.
- Bieniawski Z.T. (1984): Rock mechanics design in mining and tunneling. *A.A. Balkema*, Rotterdam, 272 p.
- Brekke T.L. and Howard T.R. (1972): Stability problems caused by seams and faults. *Rapid Tunneling & Excavation Conference, 1972*, pp. 25-41.
- Broch E. (1988): Site investigations. *Norwegian Tunnelling Today, Tapir publ.* Trondheim, Norway, pp. 49 - 52.
- Brown E.T. (1986): Research and development for design and construction of large rock caverns. *Proc. Int. Symp. on Large Rock Caverns*. Helsinki, Finland, pp. 1937-1948.
- Cecil O.S. (1971): Correlation of seismic refraction velocities and rock support requirements in Swedish tunnels. *Statens Geotekniska Institut, Publ. no. 40*, 58 p.
- Dearman W.R. (1991): Engineering geological mapping. *Butterworth - Heinemann Ltd.*, Oxford.
- Deere D.U. (1963): Technical description of rock cores for engineering purposes. *Felsmechanik un Ingenieurgeologie, Vol. 1, No 1*, pp. 16-22.
- Deere D. and Miller R.D. (1966): Engineering classification and index properties for intact rock. *Univ. of Illinois, Tech. Rept. No. AFWL-TR-65-116*, 1966.
- Dershowitz W.S., Einstein H.H. (1988): Characterizing rock joint geometry with joint system models. *Rock Mech. and Rock Engn.*, Vol 21, 1988, pp 21 - 51.
- Einstein H.H. and Baecher G.S. (1982): Probabilistic and statistical methods in engineering geology. 1. Problem statement and introduction to solution. *Rock Mechanics, Suppl. 12*, pp. 47-61.
- Einstein H.H. and Baecher G.B. (1983): Probabilistic and statistical methods in engineering geology. *Rock Mechanics, Vol. , pp 3972*.
- Ewan V.J., West G., Temporal J. (1983): Variation in measuring rock joints for tunnelling. *Tunnels & Tunnelling, April 1983*, pp 15 -18.
- Farmer I.W. and Kemeny J.M. (1992): Deficiencies in rock test data. *Proc. Int. Conf. Eurock '92, Thomas Telford, London*, pp. 298-303.
- Franklin J.A., Broch E. and Walton G. (1971): Logging the mechanical character of rock. *Trans. Inst. Min. Metall. A80*, pp. A1-A9.
- Goodman R.E. (1989): Introduction to rock mechanics. *John Wiley & Sons*, New York, 561 p.
- Hoek E. and Brown E.T. (1980): Underground excavations in rock. *Institution of Mining and Metallurgy*, London, 527 p.
- Hoek E.: (1981): Geotechnical design of large openings at depth. *Rapid Exc. & Tunn. Conf. AIME 1981*.
- Hoek E.(1986): Practical rock mechanics - development over the past 25 years. *Keynote address delivered 24.2.1986*
- Hudson J.A., Priest S.D. (1979): Discontinuities and rock mass geometry. *Int. J. Rock Mech. Min. Sci. & Geomech. Abstr.*, Vol 16, 1979, pp 339 - 362.
- Hudson J.A. and Priest S.D. (1983): Discontinuity frequency in rock masses. *Int. J. Rock Mec. Min. Sci. & Geomech. Abstr.*, Vol 20, No 2, pp. 73-89, 1983.

- Goodman R.E. (1989): Introduction to rock mechanics. *John Wiley & Sons*, New York, 561 pp.
- International Society for Rock Mechanics (ISRM), Commission on Terminology, Symbols and Graphic Representation (1975): Terminology. *Int. Soc. Rock Mech. secretary*, Lisbon.
- International Society for Rock Mechanics (ISRM), Commission on standardization of laboratory and field tests (1978): Suggested methods for the quantitative description of discontinuities in rock masses. *Int. J. Rock Mech. Min. Sci. & Geomech. Abstr.*, Vol. 15, No. 6, pp. 319-368.
- Merritt A.H. and Baecher G.B. (1981): Site characterization in rock engineering. *22nd U.S. Symp. on Rock Mechanics*, pp. 49-66
- Milne, D., Germain, P., and Potvin, Y., (1992): Measurement of Rock Mass Properties for Mine Design, *Proceedings of the ISRM-Eurock Symposium on Rock Characterization*, A.A. Balkema Publishers, Chester, England.
- Palmström A (1982): The volumetric joint count - a useful and simple measure of the degree of jointing. *Proc. int. congr. IAEG*, New Delhi, 1982, pp. V.221 - V.228.
- Palmström A. (1995): R<sub>Mi</sub> - a rock mass characterization system for rock engineering purposes. *Ph.D thesis, University of Oslo*, Norway, 409 p.
- Patton F.D. (1966): Multiple modes of shear failure in rock. *Proc. 1st Congr. ISRM, Lisbon, 1966*, I: pp. 509-513.
- Piteau D.R. (1970): Geological factors significant to the stability of slopes cut in rock. *Proc. Symp. on Planning Open Pit Mines*, Johannesburg, South Africa, 1970, pp. 33-53.
- Piteau D.R. (1973): Characterizing and extrapolating rock joint properties in engineering practice. *Rock Mechanics, Suppl. 2*, pp. 5-31.
- Robertson A.MacG. (1970): The interpretation of geological factors for use in slope theory. *Proc.Symp. Planning Open Pit Mines*, Johannesburg, South Africa, 1970. pp. 55-71.
- Sen Z., Eissa E.A. (1991): Volumetric rock quality designation. *J. Geotech. Engr.*, Vol 117, No 9, 1991, pp 1331 - 1346.
- Sen Z. and Eissa E.A. (1992): Rock quality charts for log-normally distributed block sizes. *Int. J. Rock Mech. Min. Sci. & Geomech. Abstr.*, Vol. 29, No. 1, pp. 1-12.
- Sjögren B., Øvsthus A. and Sandberg J. (1979): Seismic classification of rock mass qualities. *Geophysical Prospecting*, Vol. 27, No. 2, pp. 409 - 442.
- Sjögren B. (1984): Shallow refraction seismics. *Chapman and Hall*, London, 270 p.
- Terzaghi K. (1946): Introduction to tunnel geology. In *Rock tunnelling with steel supports*, by Proctor and White, pp 5 - 153.
- Terzaghi R. (1965): Sources of error in joint surveys. *Geotechnique*, Vol. 15, 1965, pp 287-304.

Information on rock mass characterization can be found on the web page [www.rockmass.net](http://www.rockmass.net).