



STEEL STRUCTURES

Design of

Compression Members

DR. ALI AHMED

CHAPTER # 3

DESIGN OF COMPRESSION MEMBERS

3/3

Teacher: Dr. Ali Ahmed

Book by: Prof. Dr. Zahid Ahmed SIDDIQUE



**Department of Civil Engineering
University of Engineering & Technology
Lahore**

MODIFIED SLENDERNESS RATIO

Snug Tight Connections

Snug tight connection is defined as the type in which the plates involved in a connection are in firm contact with each other but without any defined contact prestress.

It usually means the tightness obtained by the full effort of a man with a wrench or the tightness obtained after a few impacts of an impact wrench.

Obviously there is some variation in the degree of tightness obtained under these conditions. The tightness is much lesser than tensioning of the high-strength bolts.

Turn-of-Nut Method: After the tightening of a nut to a snug fit, the specified pre-tension in high-strength bolts may be controlled by a predetermined rotation of the wrench.

This procedure is called turn-of-nut method of fixing the bolts. ***Slip is allowed in turn-of-nut method.***

Turn of the nut method (Table 8 –CSA-S16)

- 1/3 turn for $L_b < 4d_b$
- 1/2 turn for $4d_b < L_b < 8d_b$ (or 200 mm)
- 2/3 turn for longer bolts

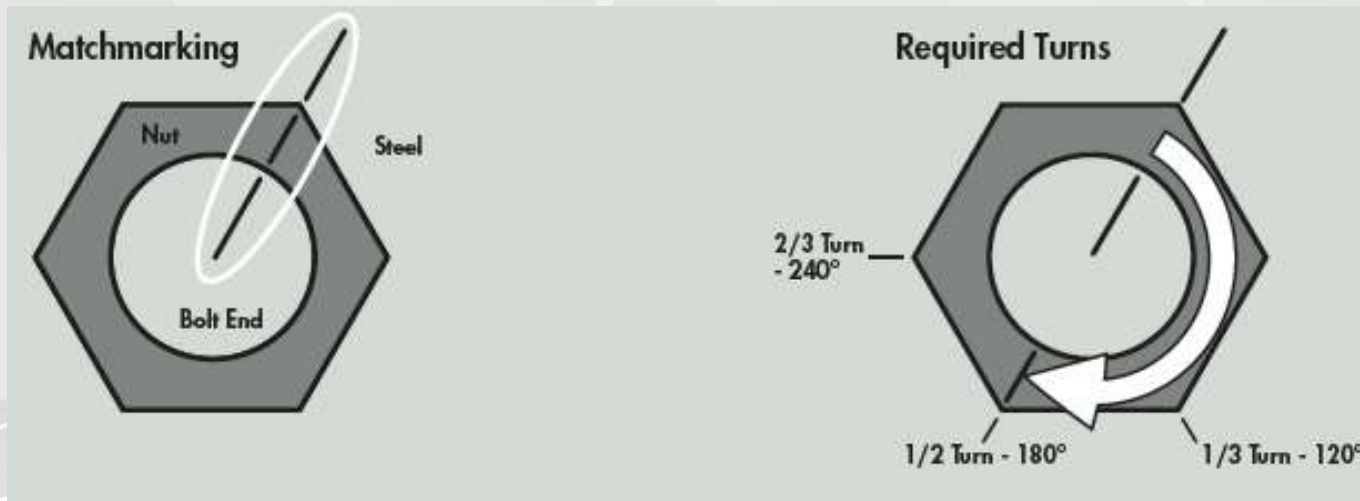

Shear Connections / Stay Plates Between Elements Of A Built-Up Member

Built-up compression members composed of two or more hot rolled shapes shall be connected to one another at intervals by stay plates (*shear connectors*) such that the maximum slenderness ratio a / r_i of individual element, between the fasteners, does not exceed the governing slenderness ratio of the built-up member, that is, the greater value of $(KL / r)_x$ or $(KL / r)_y$ for the whole section.

Shear connectors are also required to transfer shear between elements of a built-up member that is produced due to buckling of the member.

Following notation is used in further discussion of the effect of spacing of shear connectors:

a = clear distance between connectors

r_i = minimum radius of gyration of individual component

a / r_i = largest column slenderness of individual component

r_{ib} = radius of gyration of individual component relative to its centroidal axis parallel to member axis of buckling

$\left(\frac{KL}{r}\right)_0$ = column slenderness of built-up member acting as a unit

$\left(\frac{KL}{r}\right)_m$ = modified column slenderness of the built-up member as a whole

α = separation ratio = $h / (2 r_{ib})$, and

h = distance between centroids of individual components perpendicular to the member axis of buckling

Modified Slenderness Ratio Depending On Spacing Of Stay Plates

If the buckling mode of a built-up compression member involves relative deformation that produces shear forces in the connectors between individual parts, the modified slenderness ratio is calculated as follows:

(a) For snug-tight bolted connectors:

$$\left(\frac{KL}{r}\right)_m = \sqrt{\left(\frac{KL}{r}\right)_0^2 + \left(\frac{a}{r_i}\right)^2}$$

(b) for welded connectors and for fully tightened bolted connectors as required for *slip-critical joints*:

$$\left(\frac{KL}{r}\right)_m = \sqrt{\left(\frac{KL}{r}\right)_0^2 + 0.82 \frac{\alpha^2}{1 + \alpha^2} \left(\frac{a}{r_{ib}}\right)^2}$$

$(KL / r)_m$ should only be used if buckling occurs about such an axis such that the individual members elongate by different amounts. (always considered about minor axes)

For example for double angles in Figure 3.17, if buckling occurs about x-axis, $(KL / r)_m$ is not evaluated as both the angles bend symmetrically without any shear between the two.

However, if buckling occurs about y-axis, one of the angle sections is elongated while the other is compressed producing shear between the two and consequently $(KL / r)_m$ is required to be evaluated.

At the ends of built-up compression members bearing on base plates or milled surfaces, all components in contact with one another shall be connected by a weld having a length not less than the maximum width of the member, or

by bolts spaced longitudinally not more than four diameters apart for a distance equal to 1.5 times the maximum width of the member.

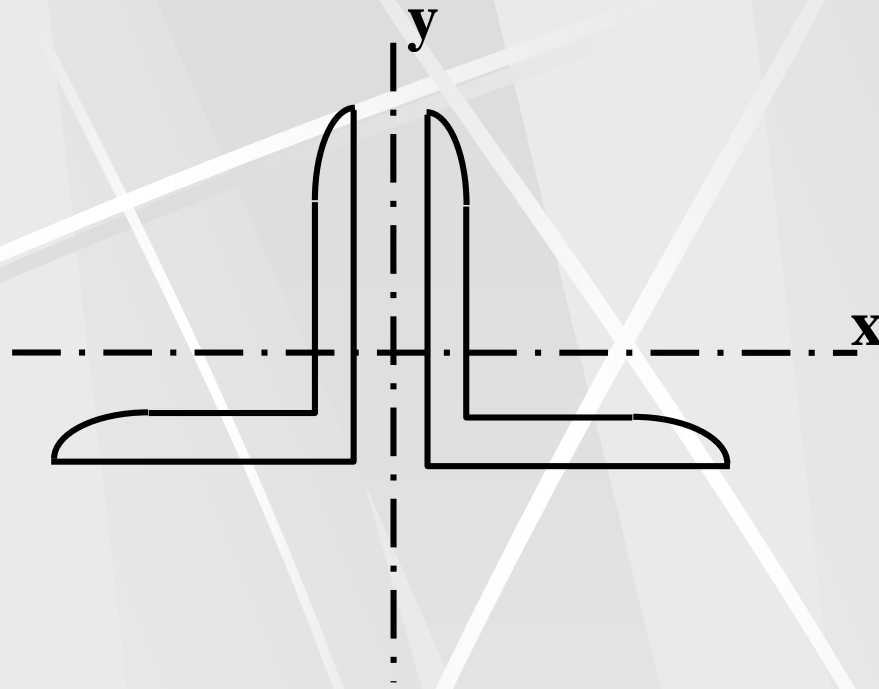

The slenderness ratio of individual component between the connectors (Ka / r_i) should not exceed **75%** of the governing slenderness ratio of the built-up member. Because we do not want local buckling before overall buckling.

CORRECTION FOR SINGLE ANGLES

FOR PLANAR TRUSSES

Single angle compression members may undergo *torsional buckling* at loads lower than the loads at which buckling may occur about x , y or z axes.

Hence, in order to closely estimate the capacity of equal leg angles or unequal leg angles connected through the longer leg, the slenderness ratio is to be modified as under:

(i) When $0 \leq L / r_x \leq 80$

$$KL/r = 72 + 0.75 L / r_x$$

(ii) When $L / r_x > 80$

$$KL/r = 32 + 1.25 L / r_x \leq 200$$

DESIGN FLOW CHART FOR COMPRESSION MEMBERS

Known Data / Inputs

P_D , P_L , L , end conditions (K -value) etc.



Calculate P_u for the controlling/critical load combination.
Also find the values of effective length factor K_x , K_y and K_z .



Assume slenderness ratio
(if column selection tables are not to be used)

- $R \approx 115$ for single angle or channel sections
- $R \approx 90$ for double angle or W sections
- $R \approx 70$ for built-up sections
- $R \approx 35$ for section continuously braced in the lateral direction



Find $\phi_c F_{cr}$ from table in *Reference-1 (Page 105-110)* , or by employing the appropriate formulas, depending on the assumed slenderness ratio.



Calculate area required for the assumed slenderness ratio.

Accordingly the *selected area may be a little greater or lesser than the calculated required area*. This may be different from the value for the actual slenderness ratio unknown at this stage and may be on the conservative or unsafe side of the actual value.

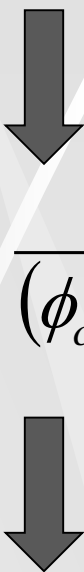
$$A_{req} \approx \frac{P_u}{(\phi_c F_{cr})_{ass}}$$

Selection of Trial Section

Use either the column selection tables (*Reference-1, Page111-154*) or adopt the trial and error procedure.

Following criteria are to be satisfied:

- a) $A_{sel} \approx \pm A_{req}$
- b) The section must have minimum possible weight.
- c) Connected leg width for various types of connections (b_{min}) is selected using one of the following expressions as applicable:
 - i. $L/40$ for $L = 2$ to 3 meter
 - ii. $3.25d + 18$
 - iii. ≥ 50 mm for welded connectionswhere d = diameter of rivets, may be assumed equal to 15mm if not known.
- d) Maximum depth of column section should generally not exceed 360mm (14in) for W sections.



Calculate Critical Slenderness Ratio

Find unsupported length in each direction L_{ux} , L_{uy} and L_{uz}



Calculate the radii of gyration (r_x , r_y , r_z) or directly see their values from the properties of sections table.



Calculate $\frac{K_x L_{ux}}{r_x}$, $\frac{K_y L_{uy}}{r_y}$ and $\frac{K_z L_{uz}}{r_z}$



R = maximum value out of the above slenderness ratios



Select spacing of stay plates denoted by a , if used, such that:

$$K \frac{a}{r_i} \leq 0.75R$$



The selected spacing must be uniform and the stay plates should satisfy the modified slenderness ratio criteria. Smaller a may be selected to reduce the modified slenderness ratio, R_m . However, *the number of stay plates in a member generally should not exceed 2 (or at the most 3).*



Calculate $R_m = \left(\frac{KL}{r} \right)_m$ about the weak axis,

which is the slenderness ratio modified for the position of stay plates, in case the buckling of the built-up section about this axis produces shear between the elements.



Perform Local Stability Check

Examine $\lambda = b/t$ ratios for stiffened and un-stiffened elements of the section and the following must be satisfied:

$$\lambda \leq \lambda_r$$

OK

For A36 Steel: (Reference-1, Page 313)

$\lambda_r = 12.7$ for single angles and double angles with separators

$\lambda_r = 15.8$ for other un-stiffened elements

$\lambda_r = 42.1$ for stiffened elements



Perform Maximum Slenderness Check

$R \leq 200$ *OK*

Otherwise revise by selection of another trial section.

R greater than 200 may be allowed in special cases as per AISC recommendations.

Compressive Capacity ($\phi_c P_n$) For $KL/r > 200$

$$P_u < \underbrace{0.75}_{\phi_c} \times \underbrace{0.9 \times 0.877}_{F_e} \frac{\pi^2 E}{(KL/r)^2} A_g \times \underbrace{\frac{1}{1000}}_{\text{To convert the result into kN}}$$

The additional factor of 0.75 is used to exceed the AISC recommended limit of 200.

$$\Rightarrow (KL/r)^2 \leq \frac{1169}{P_u} \cdot A_g$$

$$\Rightarrow \frac{KL}{r} \leq 34 \sqrt{\frac{A_g}{P_u}}$$



Find $\phi_c F_{cr}$ from tables in *Reference-1* or using formulas.



Perform Capacity Check

$$\phi_c F_{cr} \cdot A_{sel} \geq P_u \quad O K$$

Otherwise revise after fresh selection of section.



Check For Reversal Of Stresses

If $T_u > 0$, check that $\phi_t T_n \geq T_u$

Otherwise Revise



Check For Loading Cycles

Assume that loading cycles are lesser than 20,000 for ordinary buildings.



Design Stay Plates or Lacing.



**Write Final Selection using
Standard Designation**

ALTERNATE AND EASY METHOD TO SELECT TRIAL SECTION

W-Sections

Load carrying capacities ($\phi_c P_n$) for various W-sections against the values of effective lengths with respect to least radius of gyration are tabulated in Reference-1 (*Page111-137*).

Corresponding to the value of effective length $K_y L_{uy}$, a section may be selected when the tabulated $\phi_c P_n$ becomes just greater than P_u while moving from left to right in the table.

Few sections with different depths may be examined to find a minimum weight section.

To check stability of the section about the $x -$ axis, $K_x L_x$ is converted into an equivalent $K_y L_y$ by using the following expression:

$$(K_y L_y)_{eq} = \frac{K_x L_x}{r_x / r_y}$$

where r_x / r_y is used for the previously selected section.

The ratio r_x / r_y included in these tables provides a convenient method for investigating the strength of a column with respect to its major axis.

Section is selected / revised for longer of the two lengths $K_y L_y$ and $(K_y L_y)_{eq}$.

The procedure is explained as under:

Procedure

1. Find maximum values of $K_x L_x$ and $K_y L_y$.
2. Select section against $K_y L_y$ according to the loads *starting from W360 side and moving downward by weight.*
3. Find r_x / r_y for the selected section and calculate equivalent $K_y L_y$ as $K_x L_x / (r_x / r_y)$.
4. Re-enter the table for greater value out of $K_y L_y$ and $(K_y L_y)_{eq}$.
5. Revise the section if necessary.

Double Angle Sections

Column selection tables are also available for double angle sections with 10mm gusset plate in *Reference 1*, (*Page139-146*) using fully tightened stay plates.

Only difference in this case is that the load carrying capacities ($\phi_c P_n$) are listed both for $K_x L_x$ and $K_y L_y$.

While selecting section, $\phi_c P_n$ for both $K_x L_x$ and $K_y L_y$ should individually be greater than P_u .

After the selection of section, all the checks should be applied included in the general flow chart.

Example 3.1: Design a truss compression member using the following three given cross-sectional shapes:

1. 2Ls with 10 mm thick gusset plate and bolted stay plates.
2. Single angle.
3. W-section.

The other data is as under:

$$P_D = 110 \text{ kN} \quad ; \quad P_L = 140 \text{ kN}$$

$$L = 3.4 \text{ m} \quad ; \quad A36 \text{ Steel}$$

Solution:

The truss member consisting of double angles along with the gusset plate is shown in Figure 3.18.

For truss members, $K = 1$

$L_u = L$ as there is no bracing between the joints

$$\begin{aligned}
 P_u &= 1.2 P_D + 1.6 P_L \\
 &= 1.2 \times 110 + 1.6 \times 140 = 356 \text{ kN}
 \end{aligned}$$

1. Double Angles

- i. The section will be economical if it has nearly same slenderness ratio in both directions. This means that r_x and r_y should nearly be same (as the length for both directions is equal).
- ii. The radius of gyration, r_x , for the double section will be same as that for a single section.
- iii. The radius of gyration, r_y , for the double section will be considerably higher than for a single section.

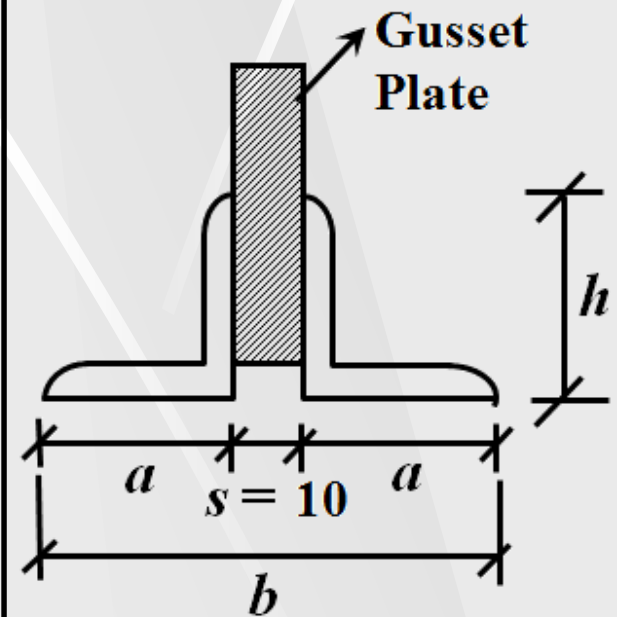

Figure 3.19. Double Angles With Gusset Plate.

- iv. From the above facts it is clear that, to make r same in both directions, unequal leg angles are to be used with the longer legs connected together.
- v. The projecting leg should be relatively smaller.

$$P_u = 356 \text{ kN} \quad : \quad KL_u = 3.4\text{m}$$

$$R_{ass} = 90$$

$$(\phi_c F_{cr})_{ass} = 146.46 \text{ MPa} \quad (\text{Reference-1, Page} = 106)$$

$$A_{req} \text{ for } 2L_s = \frac{P_u}{(\phi_c F_{cr})_{ass.}} = \frac{365 \times 1000}{146.46} = 2431, \text{mm}^2$$

$$A_{req} \text{ for single angle} = 2431 / 2 = 1216 \text{ mm}^2$$

$$b_{min} = 3.25d + 18 = 67 \text{ mm} \quad (\text{assuming } d = 15\text{mm})$$

$$L/40 = 3.4 \times 1000 / 40 = 85 \text{ mm} \quad (\text{Not fully applicable here})$$

Select section based on the following considerations:

- i. $A_{sel} \approx A_{req}$
- ii. *Minimum weight section*
- iii. $b \geq b_{min}$

Different options available are:

1. 2L 89 × 89 × 7.9 $A = 2700 \text{ mm}^2$
2. 2L 102 × 76 × 7.9 $A = 2700 \text{ mm}^2$
3. 2L 102 × 76 × 9.5 $A = 3200 \text{ mm}^2$

Note: Any one out of the first two options may be tried first.

However, calculations show that these sections are not sufficient with only the third section closer to the requirements.

The number of trials may be reduced by using column selection tables.

Using the double angles selection tables of **Reference-1 (Page 138-146)** for $P_u = 356$ kN, $K_x L_x = K_y L_y = 3.6$ m and stay plates with fully tensioned bolts, following options are available:

Section	$\phi_c P_n$ (kN)	KL (m)	Area (mm ²)
2L_s 102×76×9.5	452.8	$K_x L_x = 3.0$	3206
	382.7	$K_x L_x = 3.5$	
	396.7	$K_x L_x = 3.4$ by interpolation	
	448.8	$K_y L_y = 3.0$	
	377.8	$K_y L_y = 3.5$	
	392.0	$K_y L_y = 3.4$ by interpolation	
2L_s 102×89×9.5	482.9	$K_x L_x = 3.0$	3445
	407.0	$K_x L_x = 3.5$	
	422.2	$K_x L_x = 3.4$ by interpolation	
	555.5	$K_y L_y = 3.0$	
	492.2	$K_y L_y = 3.5$	
	504.9	$K_y L_y = 3.4$ by interpolation	

Hence, keeping in view the above values for fully tight stay plates, trial section for snug tight stay plates may be **2L_s 102×76×9.5**.

However, considering snug tight stay plates, **2L_s 102×89×9.5** may ultimately be the final result.

Trial Section 1: **2L 102 × 76 × 9.5**

$$A = 2 \times 1600 \text{ mm}^2 = 3200 \text{ mm}^2$$

Check for b_{min} : $b = 102 \text{ mm} > b_{min} = 67$ **OK**

Long legs back-to-back, connected to the gusset plate.

Check for Local Instability:

$$\lambda = \frac{b}{t} = \frac{102}{9.50} = 10.7 < \lambda_r = 12.7 \quad \text{OK}$$

Consult Page 313 on Reference-1

$$r_x = 32.0 \text{ mm as for single angle}$$

Using Reference 1 (Page 101):

$$b = 2 \times 76 + 10 = 162 \text{ mm}$$

$$\begin{aligned}(r_y)_{appr} &= b (0.19 + s/1270) \\ &= 162 \times (0.19 + 10/1270) = 32.06 \text{ mm}\end{aligned}$$

$$\frac{K_x L_{ux}}{r_x} = \frac{1 \times 3400}{32.0} \cong 107$$

$$\frac{K_y L_{uy}}{r_y} = \frac{1 \times 3400}{32.06} \cong 106$$

Although r_x is lesser than r_y , the column may buckle about y-axis if modified slenderness ratio in y-direction exceeds $K_x L_{ux} / r_x$.

Assume that snug tight bolts connect stay and gusset plates. Using 75 mm long stay plates and treating a as the *clear distance* between the stay and/or gusset plates, the *c/c* spacing of stay plates will be $a + 75$ mm.

Selection of Stay Plates Spacing:

$$\begin{aligned} a / r_i &= 0.75 \times \text{larger of } K_x L_{ux} / r_x \text{ and } K_y L_{uy} / r_y \\ &= 0.75 (107) = 80.25 \end{aligned}$$

$$r_i = r_z = 16.4 \text{ mm}$$

$$a_{max} = 80.25 \times 16.4 / 1000 = 1.316 \text{ m}$$

For 75 mm long stay plates,

Number of spaces between stay plates:

$$= \frac{L}{a_{max} + 75} = \frac{3400}{1316 + 75} = 2.45 \quad \text{Say } \underline{\underline{3 \text{ spaces}}}$$

Number of stay plates = No. of spacing – 1 = 2

$$a = 3400 / 3 - 75 = 1058 \text{ mm}$$

Note: Number of stay plates may not generally exceed three.

$$a / r_i = 1058 / 16.4 = 64.53$$

For snug tight plates:

**Formula is also given on
Reference-1 Page 314**

$$\left(\frac{K_y L_{uy}}{r_y} \right)_m = \sqrt{\left(\frac{KL}{r} \right)_0 + \left(\frac{a}{r_i} \right)} = \sqrt{106.05^2 + 64.53^2} \cong 125$$

$R =$ larger of $K_x L_{ux} / r_x$ and modified $K_y L_{uy} / r_y = 125$

Maximum Slenderness Ratio Check:

$$R \leq 200$$

(OK)

Capacity Check:

From table of Reference-1 (*Page 106*):

$$\text{For } R = 125, \quad \phi_c F_{cr} = 98.28 \text{ MPa}$$

$$\phi_c F_{cr} A_{sel} = 98.28 \times 2 \times 1600 / 1000$$

$$= \mathbf{314.50 \text{ kN}} < P_u = \mathbf{356 \text{ kN}} \quad (\mathbf{NG})$$

Trial Section 2: **2L 102 × 89 × 9.5**

$$A = 2 \times 1720 \text{ mm}^2$$

Check for b_{min} : $b = 102 \text{ mm} > b_{min} = 67 \text{ mm}$ (**OK**)

Long legs back-to-back, connected to the gusset plate.

Check for Local Instability:

$$\lambda = \frac{b}{t} = \frac{102}{9.50} = 10.7 < \lambda_r \quad \lambda_r = \mathbf{12.7} \quad \mathbf{OK}$$

Example 3.2: Members Under Stress Reversal:

Design a bridge truss compression member ($K=1$) that is 3.5m long. $P_D = 80$ kN(C), $P_L=270$ kN(C), $T_L = 270$ kN(T).

Select following two types of sections:

- a) $2L_s$ with 15 mm thick gusset plate, welded connections but snug bolted stay plates.
- b) W-section, welded connections.

Solution

$$\begin{aligned} P_u &= 1.2 P_D + 1.6 P_L \\ &= 1.2 \times 80 + 1.6 \times 270 = 528\text{kN} \end{aligned}$$

$$\begin{aligned} T_u &= -1.2 P_D + 1.6 T_L \\ &= -1.2 \times 80 + 1.6 \times 270 = 336\text{kN} \end{aligned}$$

$(1+0.015L^2)P_u > T_u \Rightarrow$ Design as compression member for P_u and then check as tension member for T_u .

Complete the example yourself

EQUAL STRENGTH COLUMN

Equal strength column is defined as a column having same critical buckling strength along both strong and weak axes.

In other words, for an equal strength column, KL / r ratio along both the axes should approximately be the same.

The material of the column is used more efficiently if this criterion is satisfied which results in the most economical column design.

For an equal strength column, ratio of radii of gyration in the two directions should be equal to the ratio of effective length in the two directions.

$$\frac{K_x L_x}{r_x} = \frac{K_y L_y}{r_y} \Rightarrow \frac{r_x}{r_y} = \frac{K_x L_x}{K_y L_y}$$

Bracing is provided in such a way that the above equation is approximately satisfied. The ratio r_x / r_y is the main criterion for design of bracing. Knowing $K_x L_x$ and r_x / r_y ratio, the required effective unbraced length along y-axis may be determined as follows:

$$K_y L_y = \frac{K_x L_x}{r_x / r_y}$$

If unbraced length in both direction are known then LRFD specifications can be used to select W-section from column section tables by determining the $(K_y L_y)_{eq}$.

$$(K_y L_y)_{eq} = \frac{K_x L_x}{r_x / r_y}$$

If $(K_y L_y)_{eq}$ is more than $K_y L_y$ then buckling is expected about the x-axis

Example 3.3: A 9 m long column in a frame structure is to resist an axial factored compressive load (P_u) of 1600 kN. Assume the bottom end of the column to be pinned and top end to be fixed in both directions. The column is braced at $L/3$ height **along weak axis**. Assume that there is no sidesway between the top and bottom points. Design a Wide Flange Section (W) using A36 steel and AISC Specification.

Buckling of the column with braces results in rotation of the main member at the brace points and lateral bracing does not prevent this rotation.

Hence, mid-point may be considered just like a hinge for that direction (Figure 3.22).

However, lateral translation or sway of the central point is almost zero.

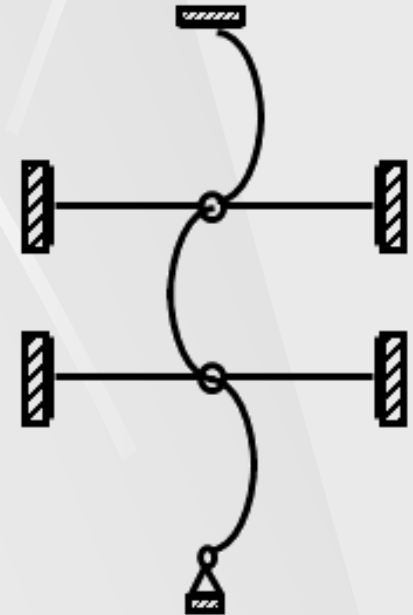
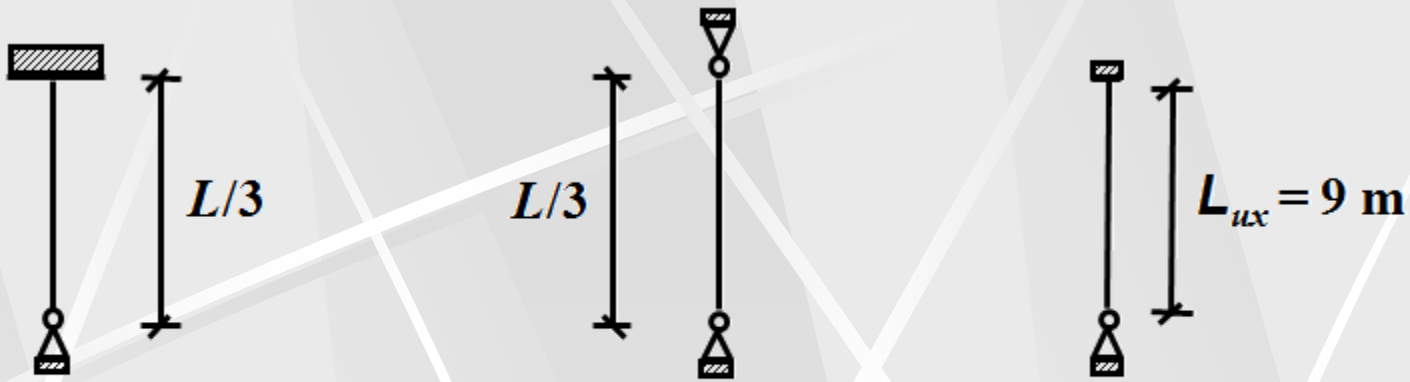

Figure 3.22. Buckling of Column Along Weak Axis



(a) Top Half of Column Buckling in Weak Direction.

(b) Bottom Half Column Buckling in Weak Direction

(c) Column Buckling in Major Axis Direction

Figure 3.23. Effective Lengths for Buckling of Column.

Solution:

$$P_u = 1600 \text{ kN}$$

$$R_{ass} = 90, \quad \phi_c F_{cr} = 146.46 \text{ MPa}$$

$$A_{req} = \frac{P_u}{\phi_c F_{cr}} = \frac{1600 \times 1000}{146.46} = 10925, \text{ mm}^2$$

$K_y = 0.8$ for top portion (Figure 3.23 (a))

$K_y = 1.0$ for bottom portion (Figure 3.23 (b)) \leftarrow **critical**

Further, AISC Specification recommends $K = 1.0$ for *braced columns*

$$K_x = 0.8 \text{ (Figure 3.23 (c))}$$

$$\text{Use } K_x = 1.0$$

$$K_y L_{uy} = 1.0 \times \frac{9}{3} = 3.0, m$$

$$K_x L_{ux} = 1.0 \times 9 = 9.0, m$$

$$\frac{r_x}{r_y} = \frac{K_x L_x}{K_y L_y} = \frac{9}{3} = 3$$

Hence r_x / r_y of the selected section closer to 3.0 will be preferable

Following options are available:

1	W 360×72	$A = 9,100$	mm^2	$r_x / r_y = 3.06$
2	W 360×91	$A = 11,500$	mm^2	$r_x / r_y = 2.44$
3	W 310×86	$A = 11,000$	mm^2	$r_x / r_y = 2.10$
4	W 310×97	$A = 12,323$	mm^2	$r_x / r_y = 1.75$

The first option has *area less than the assumed required* value but r_x / r_y is close to 3.0.

This may be tried as first option. The other options, although have greater area, may fail.

Trial section: W 360×72

$$A = 9100 \text{ mm}^2, \quad r_x = 149 \text{ mm}, \quad r_y = 48.5 \text{ mm}$$

Check for Local Instability:

$$\frac{b_f}{2t_f} = 6.7 < \lambda_r \quad \lambda_r = 15.8 \quad \text{OK}$$

$$\frac{h}{t_w} = 33.5 < \lambda_r \quad \lambda_r = 42.1 \quad \text{OK}$$

Maximum Slenderness Ratio Check:

$$\frac{K_x L_{ux}}{r_x} = \frac{9000}{149} \cong 61$$

$$\frac{K_y L_{uy}}{r_y} = \frac{3000}{48.5} \cong 62 \quad \Leftarrow \quad \text{Critical}$$

$$R = 62 < 200 \quad \text{OK}$$

Using Reference 1: $\phi_c F_{cr} = 183.52 \text{ MPa}$

$$\phi_c P_n = 183.52 \times 9100/1000 = 1670 \text{ kN}$$

$$> P_u = 1600 \text{ kN} \quad \text{OK}$$

Final Selection: W 360x72

Note: In this example, area of the qualifying section is lesser than the assumed required area.

This is only because of selecting the equal strength column.

Further, by using the column selection tables, the criterion of equal strength is automatically satisfied.

Alternative Method by Column Section Table

$$K_y L_{uy} = 1.0 \times \frac{9}{3} = 3.0, m \quad K_x L_{ux} = 1.0 \times 9 = 9.0, m$$

$$1 \quad \mathbf{W 360 \times 72} \quad \mathbf{A = 9,100 \text{ mm}^2} \quad \mathbf{\phi_c P_n = 1672 \text{ kN},} \quad \mathbf{r_x / r_y = 3.06}$$

$$(K_y L_y)_{eq} = \frac{K_x L_x}{r_x / r_y} = \frac{9}{3.06} = 2.94$$

Re-enter into the column section tables of W-section and select the section for the larger value of $K_y L_y$ and $(K_y L_y)_{eq}$.

Note: Since $K_y L_y > (K_y L_y)_{eq}$ the same (previous) section may be satisfied.

Example 3.4: Design a W-section column in a building frame of 4m story height for an axial factored compressive load (P_u) of 975 kN. The frame is braced against sidesway along its weak axis but sidesway is allowed along the major axis ($K = 2$). Assume the ends of the column to be pinned at the base and fixed at the top.

Solution:

Note: If the y-direction is continuously braced, there is no need to consider slenderness effects in that direction.

$$P_u = 975 \text{ kN}$$

$$R_{ass} = 90 \quad \phi_c F_{cr} = 146.46 \text{ MPa}$$

$$A_{req} = \frac{P_u}{\phi_c F_{cr}} = \frac{975 \times 1000}{146.46} = 6658, \text{ mm}^2$$

Using Reference 1 (Page# 103)

$$K_x = 2.0, \quad K_y = 1.0$$

$$L_{ux} = L_{uy} = 4 \text{ m} \quad : \quad K_x L_{ux} = 8 \text{ m} \quad : \quad K_y L_{uy} = 4.0 \text{ m}$$

$$\frac{r_x}{r_y} = \frac{K_x L_{ux}}{K_y L_{uy}} = 2 \quad \Rightarrow \quad r_x / r_y \text{ close to } 2.0 \text{ will be preferred.}$$

For $P_u = 975 \text{ kN}$ and $K_y L_y = 4.0 \text{ m}$, the selected section using the column selection tables is W 250×49.1.

For W250 sections

$$r_x / r_y = 2.16$$

and

$$(K_y L_y)_{eq} = 8.0 / 2.16 = 3.7 \text{ m.}$$

Hence $(K_y L_y)_{eq}$ is not critical with respect to $K_y L_y$.

Trial Section: **W250×49.1**

$$A = 6260 \text{ mm}^2 ; \quad r_x / r_y = 2.15 ; \quad d = 247 \text{ mm} ; \quad b_f = 202 \text{ mm}$$
$$t_f = 11.0 \text{ mm} ; \quad t_w = 7.4 \text{ mm} ; \quad r_x = 106 \text{ mm} ; \quad r_y = 49.3 \text{ mm}$$

Check for Local Instability:

$$\frac{b_f}{2t_f} = 9.1 < \lambda_r \quad \lambda_r = 15.8 \quad \text{OK}$$

$$\frac{h}{t_w} = 27.1 < \lambda_r \quad \lambda_r = 42.1 \quad \text{OK}$$

Maximum Slenderness Ratio Check:

$$\frac{K_x L_{ux}}{r_x} = \frac{1 \times 8000}{106} \cong 76$$

$$\frac{K_y L_{uy}}{r_y} = \frac{1 \times 4000}{49.3} \cong 82$$

$$R = 82 < 200 \quad \text{OK}$$

Using Reference 1: $\phi_c F_{cr} = 157.54 \text{ MPa}$

$$\phi_c P_n = 157.54 \times 6260/1000 = 986 \text{ kN}$$

$$> P_u = 975 \text{ kN} \quad \text{OK}$$

Final Selection: W 250x49.1

BUILT-UP SECTIONS AND LACING

Built-up section for a compression member becomes efficient due to the fact that slenderness ratio of composite section can be made equal in both directions.

This will give equal strength column with minimum weight section.

The spacing between the individual elements may be varied to get desired radius of gyration.

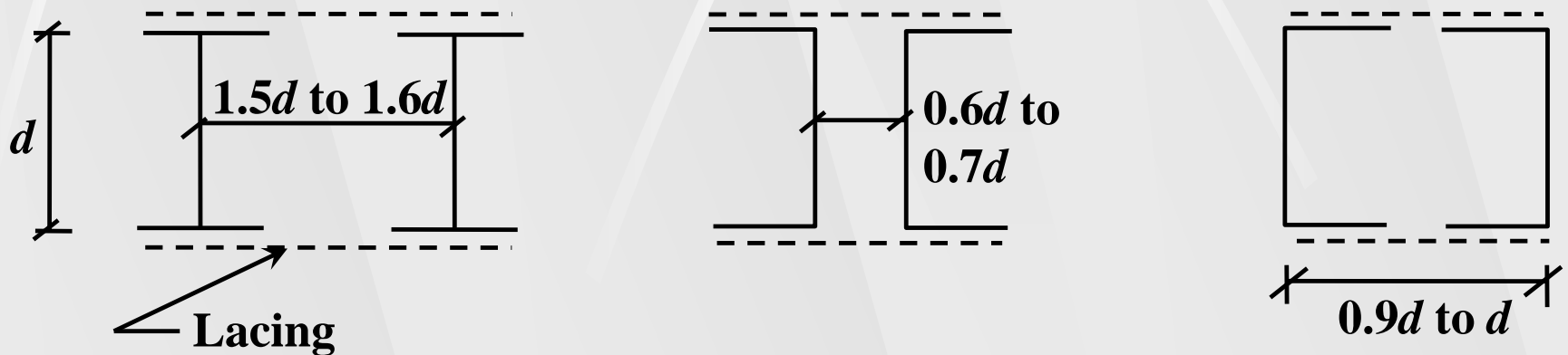

Figure 3.24. Built-Up Section with Lacing

Lacing is defined as plates, angles or other steel shapes used in a lattice configuration that connect two steel shapes together.

The purpose of lacing bars is to make the entire components act as a single unit.

When a structural member is consisting of two or more shapes and cover plates are not provided, lacing elements must be used.

Functions of lacing elements are as follows:

1. To provide resistance against shearing force (force transverse to the built-up member) developed by bending produced due to buckling or due to simultaneous action of bending moment. Shear is to be transferred among the elements of a built-up section so that it behaves as a single member.

2. To decrease the effective length of individual components.
3. To hold the various parts parallel and the correct distance apart.
4. To equalize the stress distribution between the various parts.
5. To allow wind to pass through reducing the wind pressure.

Note: *Area of lacing is not included in composite area of cross-section of the column as it is not continuously present throughout the length. However, area of cover plates present continuously must be included.*

TYPES OF LACING

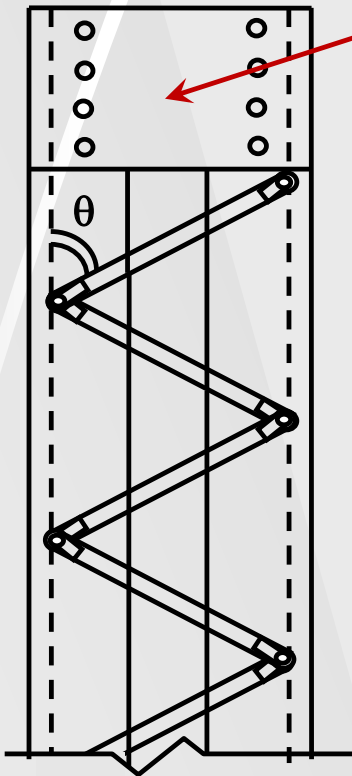
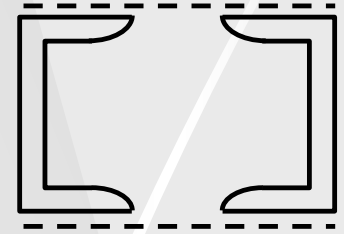
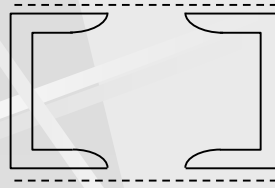
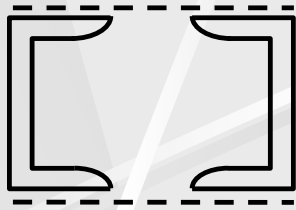

End Tie Plate

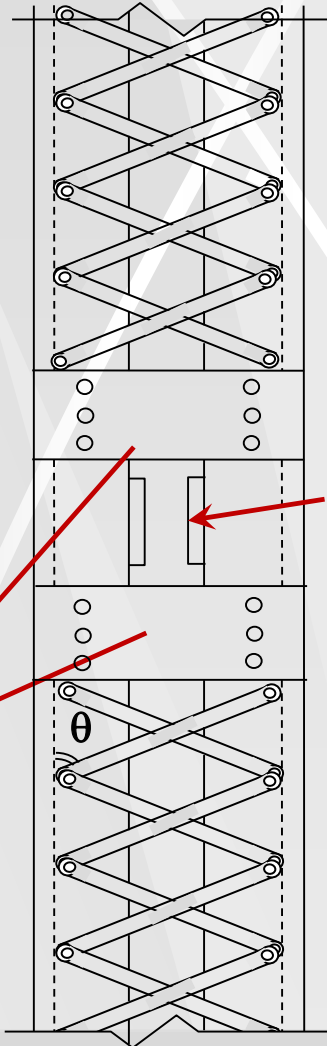

Gusset Plates

A

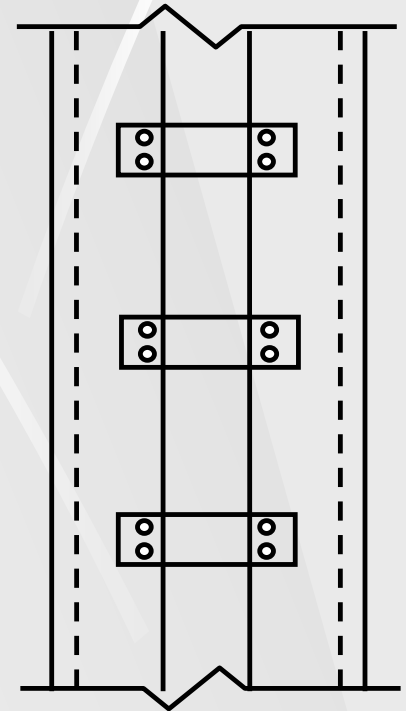

3) Battens

1) Single Lacing

2) Double Lacing

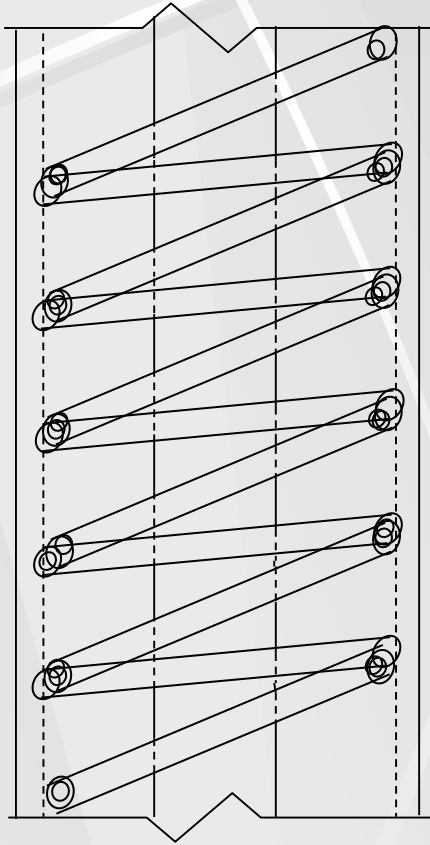

**4) Lacing and
Battens**

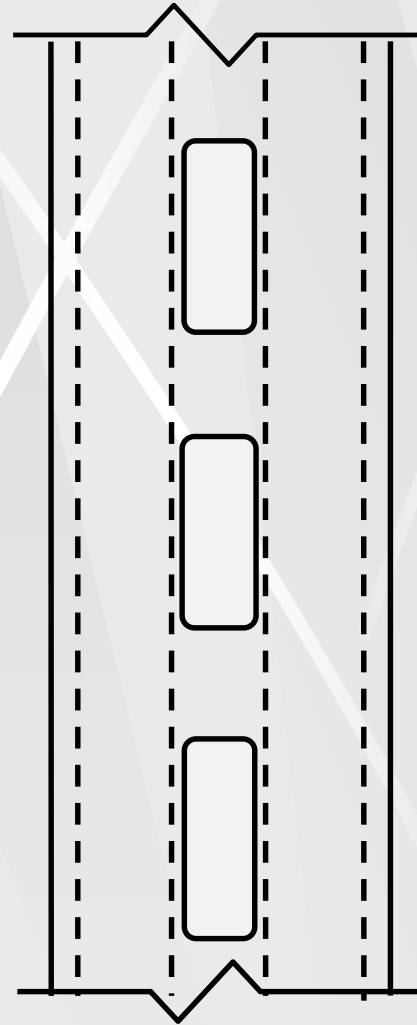

**5) Perforated
Cover Plates**



Lacing usually consists of flat bars but may occasionally consist of angles, perforated cover plates, channels or other rolled sections

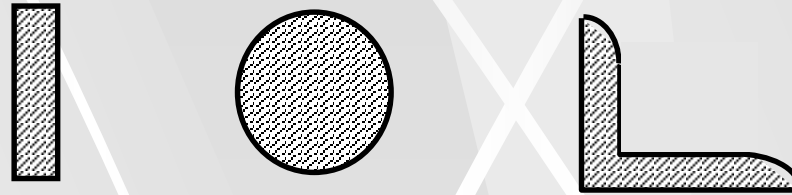

Figure 3.26. Sections Used As Lacing.

1. The lacing elements must be so placed that the individual parts being connected will have slenderness values less than the governing slenderness ratio for the entire built-up member.
2. In riveted construction, the effective length, denoted by **a**, of lacing bars for the determination of the permissible stress ($\phi_c F_{cr}$) shall be taken as the length between the inner end rivets of bar for single lacing and as 0.7 of the length for double lacing

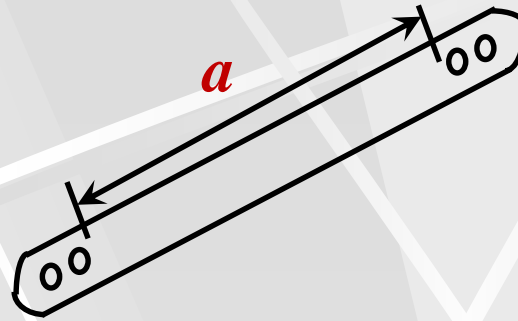

Figure 3.26. Effective Length of Lacing Element

In welded construction, the effective length shall be taken as the distance between the inner ends of effective weld lengths connecting the lacing bars to the main member elements for single lacing and 0.7 of this length for double lacing.

3. The AISC column formulas are used to design the lacing in the usual manner. The additional lacing provisions are discussed in AISC-E6.2.
4. Slenderness ratios are limited to 140 for single lacing and 200 for double lacing.

5. Double lacing should be used if the distance between connection lines between the lines of welds or fasteners in the flanges, denoted by s , is greater than 380 mm.

The above information is summarized in the following table:

Type	θ	L_e	L_e/r	s
Single lacing	60°	L	≤ 140	≤ 380 mm
Double lacing	45°	$0.7L$	≤ 200	> 380 mm

6. Lacing is assumed to be subjected to a shearing force normal to the built-up member, denoted by V_u , equal to not less than 2% of the total compressive design strength $\phi_c P_n$ of the member. This force should be equally divided into lacing elements at a particular cross-section.

$$V_u = 0.02 \times \phi_c P_n$$

7. Lacing bars may be under tension and compression alternately. However, compression in bars is more critical and design is performed for it. If N is the number of parallel planes of lacing, shear on one lacing face will be V_u/N .

For single lacing, component of axial compression should provide the required shear component. That is, F_u is resolved into V_u/N and not the reverse, refer to Figures 3.29 and 3.30.

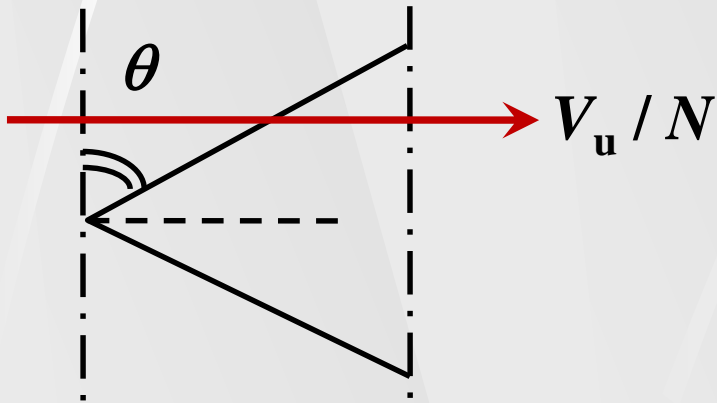

Figure 3.29. Shear Force Acting On Single Lacing.

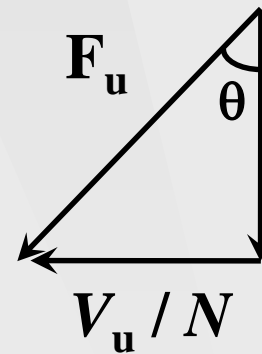

Figure 3.30. Member Axial Force to Get Required Shear.

$$F_u \sin \theta = \frac{V_u}{N}$$

$$\therefore \text{Force in single lacing} = F_u = \frac{V_u}{N \sin \theta}$$

$$\text{Force in double lacing} = F_u = \frac{V_u}{2N \sin \theta}$$

8. The transverse centre-to-centre distance between the rivets or centroid of welds may easily be found from the known standard gage distances of the individual elements.

Let ; b = clear distance between webs of the elements in a composite section

g = standard gauge distance

Then, $s = b - 2g$ for parts facing each other

$s = b + 2g$ for parts facing back to back

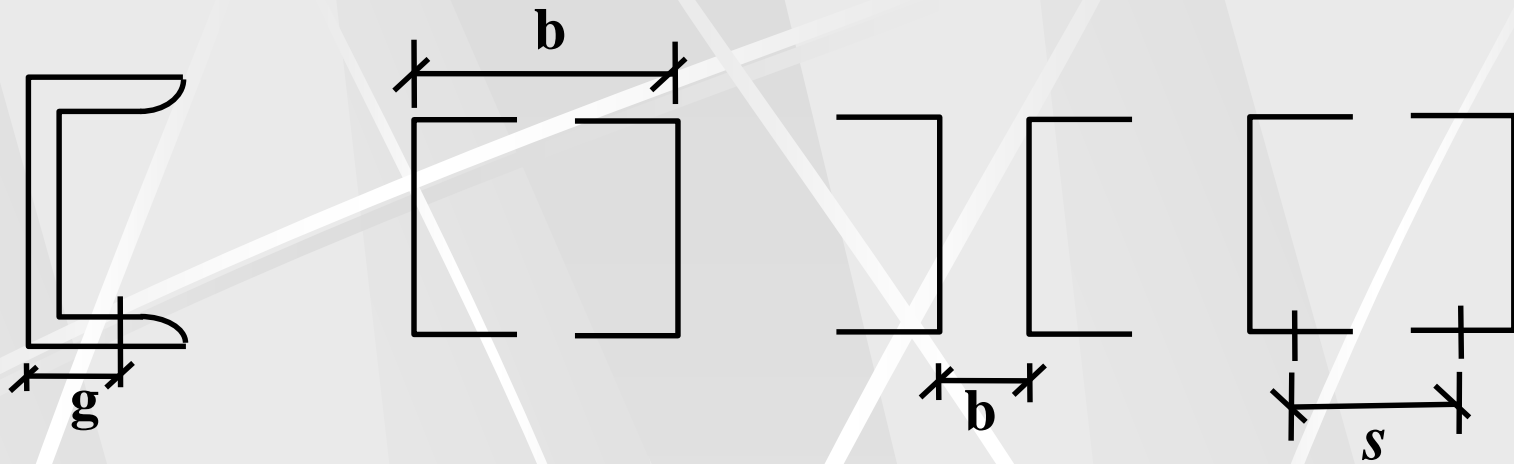

Figure 3.31. Calculations of Distance Between the Connection Lines

9. The AISC-D4 Specification states that the end tie plates shall have a thickness at least equal to **1/50** the distance between the connection lines of rivets, bolts, or welds and shall have a length parallel to the axis of the main member at least equal to the distance between the connection lines. Intermediate plates can have half this length. The welding on each line connecting a tie plate must not be less than one-third the length of the plate.

The spacing of bolts in the direction of stress in tie plates must not be more than **6d** and the tie plates must be connected to each segment by at least three fasteners. The longitudinal spacing of intermittent welds or fasteners at tie plates must not exceed **150 mm**.

Thickness of tie plates, $t \geq s / 50$
Minimum length of tie plate = s

10. The slenderness ratio (L/r) of the flange between lacing points should not be more than three-fourth (75%) of the overall slenderness ratio of the main member.

$$\frac{L}{r_{\min}} = \frac{L}{0.289t_f} \leq \frac{3}{4}R$$

$$r_{\min} = \sqrt{\frac{bt^3/12}{bt}} = 0.289t$$

OR

$$4.61 \frac{L}{t_f} \leq R$$

11. Flat bar for lacing should have the following minimum width considering minimum edge clearance ($1.5d$) from centre of rivets to all sides.

$$b_{min} = (1.5d) \times 2 = 3d$$

12. Batten plate is defined as a rigidly connected plate element used to join two parallel components of a built-up section. This is designed to transmit shear between the two components of the main member.

13. Double lacing bars shall be joined together at their intersections.

DESIGN FLOW CHART FOR BUILT-UP MEMBERS

Main Member: This flow chart is exactly same as the general compression member flow chart presented earlier.

$$P_u, L_{ux}, L_{uy}, K_x, K_y$$



R is assumed



$\phi_c F_{cr}$ is evaluated for the assumed R



A_{req} is calculated

Selection of built-up section and checking local stability

$KL/r \leq 200$ (If not, revise the section)

$\phi_c F_{cr}$ is evaluated for the actual slenderness ratio

$$\phi_c P_n = A_{sel} \times \phi_c F_{cr} \geq P_u$$

(If not, revise the section)

Design of Lacing

$$V_u = 0.02 \phi_c P_n$$



Force in each lacing bar = $F_u = \frac{V_u}{N \sin \theta}$ or $\frac{V_u}{2N \sin \theta}$



Length of lacing bar = $L_e = s / \sin \theta$
or $s / \sin \theta \times 0.7$ for double lacing



Calculate length between the lacing points along the main member (L) and check the following condition.

If the condition is not satisfied, increase the angle θ .

$$4.61 L / t_f \leq R$$

$L_e/r \leq 140$ for single lacing and
 $L_e/r \leq 200$ for double lacing



Find $\phi_c F_{cr}$ depending on maximum allowed L_e/r



$$A_{req} = F_u / \phi_c F_{cr}$$



For local stability: $b/t \leq 10.8$ (*preferably*)



Determine the section for lacing bars, satisfying the above requirements



Design end tie plates

Example 3.5: Design a column of length 8m, pinned at both ends, consisting of **two channels** placed back-to-back at a distance of 250 mm. Also design flat lacing using 15 mm diameter rivets. $P_u = 3200 \text{ kN}$.

Solution:

$$P_u = 3200 \text{ kN} \quad : \quad KL_u = 8.0\text{m}$$

$$R_{ass} \text{ for built-up section} = 70$$

$$(\phi_c F_{cr})_{ass} = 173.53 \text{ MPa} \quad (\text{Reference-1, Page} = 106)$$

$$A_{req} \text{ for } 2C_s = \frac{P_u}{(\phi_c F_{cr})_{ass.}} = \frac{3200 \times 1000}{173.53} = 18,440.0, \text{mm}^2$$

$$A_{req} \text{ for one channel} = 9,220 \text{ mm}^2$$

Using Reference 1, three sections with the same weight (74kg/m) may be selected.

However, 2Cs 380 × 74.0 have depth greater than the other sections, which may be undesirable.

Similarly, 2Cs 310 × 74.0 have lesser r_x -value.

Trial Section: 2MC_s 330 × 74.0 $A = 9480 \text{ mm}^2$

$$r_x = 117 \text{ mm} ; \quad r_y = 26.9 \text{ mm} ; \quad d = 330 \text{ mm}$$

$$b_f = 112 \text{ mm} ; \quad t_f = 15.5 \text{ mm} ; \quad t_w = 20.0 \text{ mm}$$

Check for Local Instability:

$$\lambda = \frac{b_f}{t_f} = \frac{112}{15.5} = 7.23 < \lambda_r \quad \lambda_r = 12.7 \quad \text{OK}$$

$$\lambda = \frac{h}{t_w} = \frac{330 - 2 \times 15.5}{20} = 14.95 < \lambda_r \quad \lambda_r = 42.3 \quad \text{OK}$$

Using Reference 1(Page 101), approx. values of r_x and r_y are:

$$(r_x)_{appr} = 0.36b = 0.36 \times 330 = 118.8 \text{ (Exact value is 117mm)}$$

$$(r_y)_{appr} = 0.6h = 0.6 \times 250 = 150$$

Exact value of r_y should preferably be calculated for the last trial.

In case of lacing, the individual slenderness ratio is usually very small and modified slenderness ratio will be very close to the original slenderness ratio.

Capacity Check:

$$\frac{KL}{r_{\min}} = \frac{1 \times 8000}{118.8} \cong 68 < R \quad \mathbf{R=200} \quad \mathbf{OK}$$

$$\phi_c F_{cr} = 176.09 \text{ MPa} \quad \text{Using Reference 1(Page 106)}$$

$$\begin{aligned}\phi_c P_n &= 176.09 \times 2 \times 9480 / 1000 \\ &= 3338 \text{ kN} > P_u = 3200 \text{ kN} \quad \text{OK}\end{aligned}$$

Final Selection: 2MCs 330 × 74.0

Design of Lacing:

$$V_u = 0.02 \phi_c P_n = 0.02 \times 3338 = 66.8 \text{ kN}$$

Using Reference-1 (Page 100), standard gauge
 $g = 64 \text{ mm}$ for $b_f = 112 \text{ mm}$

$$\begin{aligned}s &= b + 2g \\ &= 250 + 2 \times 64 = 378 \text{ mm}\end{aligned}$$

$s < 380 \Rightarrow$ single lacing
 and $\theta = 60^\circ$

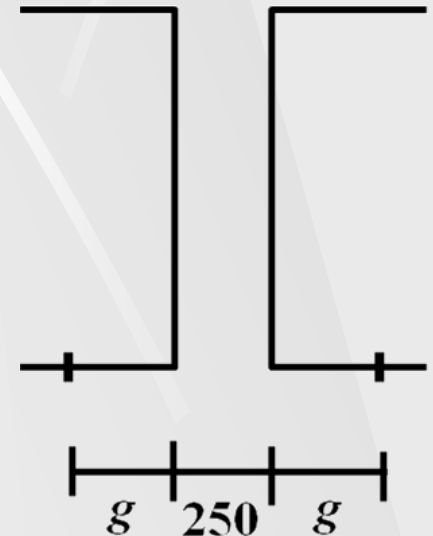

Figure 3.32. Configuration of Double Channel Section

Longitudinal length between lacing points

$$L = 2 \times s / \tan \theta = 437 \text{ mm}$$

$$4.61 L / t_f = 4.61 \times 437 / 15.5 \\ = 130.0 > \mathbf{R = 68}$$

(Revise the angle θ)

For $\theta = 75^\circ$, $L = 203 \text{ mm}$,

$$4.61 L / t_f = 4.61 \times 203 / 15.5 \\ = 60.4 < \mathbf{R = 68} \quad (\mathbf{OK})$$

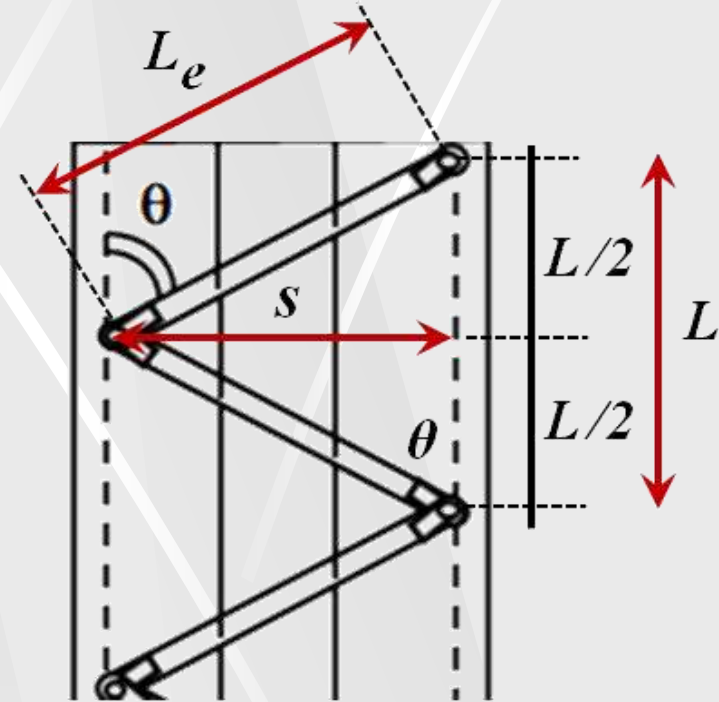

Force in each lacing bar, (F_u)

$$F_u = \frac{V_u}{N \sin \theta} = \frac{66.8}{2 \times 75} = 34.6, \text{ kN}$$

Length of lacing, (L_e)

$$L_e = s / \sin \theta = 378 / \sin 75^\circ = 391 \text{ mm}$$

Referring to Figure 3.33, four conditions are to be satisfied in finding b and t .

1. $L_e/r \leq 140$ (maximum slenderness ratio)

2. $b \times t \geq \frac{F_u}{\phi_c F_{cr}}$ (for required Comp. strength)

3. $b/t \leq 10.8$ (For local stability)

4. $b \geq 3d$ (to properly accommodate the rivet)

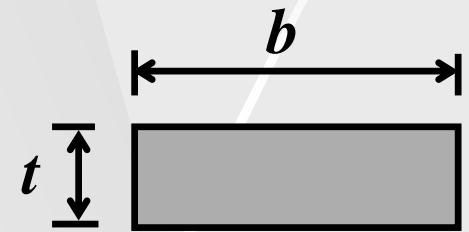

Figure 3.33. Cross Section of Flat Lacing

Properties of a flat bar are:

$$A = b \times t, \quad I_{min} = bt^3/12, \quad r_{min} = \sqrt{\frac{bt^3/12}{bt}} = 0.289t$$

Using first condition, $L_e/r \leq 140$

$$\frac{L_e}{r_{min}} = \frac{391}{0.289t} \leq 140 \Rightarrow t \geq 9.64 \text{ mm}$$

try 10 mm thick bar ($t=10\text{mm}$)

To satisfy the second condition;

$$\frac{L_e}{r_{\min}} = \frac{391}{0.289 \times 10} = 135.3$$

$$\phi_c F_{cr} = 84.24 \text{ MPa}$$

$$A_{\text{req}} = b \times 10 \geq \frac{Fu \times 1000}{\phi_c F_{cr}} = \frac{34.6 \times 1000}{84.24}$$

$$b_{\min} = 41.1 \text{ mm}$$

Using third condition, $b/t = 10.8$

$$b_{\max} = 10.8 \times 10 = 108 \text{ mm}$$

Using fourth condition, $b \geq 3d$

for diameter of rivet $d = 15\text{mm}$, we have:

$$b_{\min} = 3d = 3 \times 15 = 45 \text{ mm}$$

Hence the plate width should be between 45mm and 108 mm.

Let $b = 50 \text{ mm}$

$$\begin{aligned} \text{Minimum length of lacing bar} &= L_e + 3d \\ &= 365 + 3 \times 15 = 410 \text{ mm} \end{aligned}$$

Provide $50 \times 10 \text{ mm}$ plate, 425 mm long

End Tie Plate;

$$t_p \geq s / 50 = 378 / 50 = 7.56 \text{ mm}$$

$$t_p = \mathbf{8 \text{ mm}}$$

Minimum length of tie plate = $s = 378 \text{ mm}$

$$\begin{aligned} \text{Width of tie plate} &\approx \text{Width of section} \\ &= 250 + 2 \times 112 = 474 \text{ mm} \end{aligned}$$

Use $8 \times 470 \times 470 \text{ mm}$ End Tie PLs

Assignment

Questions of Chapter 3